

# **BAND-IT**<sup>®</sup>

THE ULTIMATE BAND FASTENING SYSTEM

## **2020 PRODUCT SOLUTIONS GUIDE**

**BAND-IT'S INDUSTRIAL APPLICATIONS**

*STAINLESS STEEL FASTENING AND BANDING*

**HOSE CLAMPING  
& IDENTIFICATION**



**CABLE MANAGEMENT**



**INFRASTRUCTURE**



[www.band-it-idex.com](http://www.band-it-idex.com)

# **ESSENTIALLY EVERYWHERE**

## **BAND-IT® is an innovative clamping solutions company providing service and value second to none!**



Founded in Denver, Colorado in 1937, BAND-IT® is acknowledged as the world leader in quality engineered fastening solutions. A unit of IDEX corporation, BAND-IT® has an international network of representatives and distributors, with manufacturing and distribution facilities serving users worldwide.

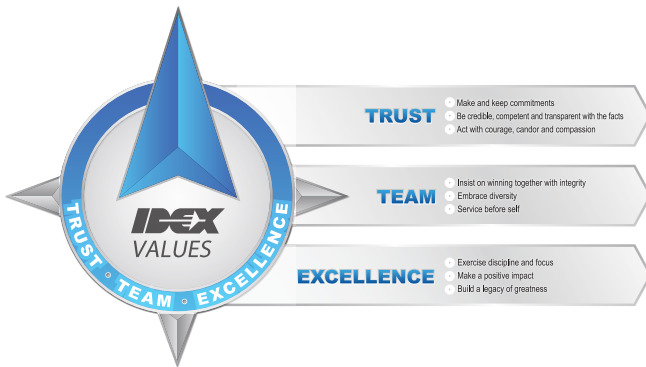

### **Certificates**

As demonstration of our ongoing commitment to excellence, quality and environmental management, BAND-IT is proud to display the following certificates of compliance to the prestigious International Standards:

- ISO 9001
- ISO 14001
- ISO/TS16949

Since becoming ISO/TS certified, BAND-IT® continues to seek new and innovative ways to manufacture products through our continuous efforts upgrading equipment, employee training and internal quality assurance in our quest to deliver the best products within the market place to our customers.

### **Patents:**

6,014,792 - Ultra-Lok® band clamp including separately attached buckle

- 6,260,704 B - Band tote assembly
- 6,481,467 - Pneumatic Automatic Air Tool S350
- 7,650,680 - Improved dimple locking method for bundling objects
- 7,484,274 - Free end band and seal
- 8,146,212 - Free end band

### **Trademarks:**

BAND-IT®, BAND-IT Jr., Junior®, BAND-FAST®, COLOR-IT®, Tie-Lok®, Tie-Lok Tool®, and Ultra-Lok® are registered trademarks owned by BAND-IT IDEX, Inc., a unit of IDEX Corporation.



#### **World Headquarters**

North American Operations  
BAND-IT IDEX, Inc.  
Western Hemisphere Sales and Marketing  
Tel: (303) 320-4555  
Toll Free : 800-525-0758  
Fax: (303) 333-6549  
Email:  
info.BAND-IT@idexcorp.com  
Website:  
www.band-it-idex.com

#### **European Operations**

BAND-IT Company Limited  
Tel: (44) 1246-477333  
UK Sales Tel:  
(44) 1246-479479  
European Sales Tel:  
(44) 1246-479480  
Fax (44) 1246-476324  
Sales Email:  
BAND-ITUKSALES.  
BAND-IT@idexcorp.com  
Email:  
EUROPEinfo.BAND-IT@  
idexcorp.com  
Website:  
www.band-it-idex.com

#### **Singapore Sales Office**

BAND-IT Asia Pacific Pte.  
LTD.  
Tel: (65) 6684-7312 /  
(65) 6684-7317  
Fax: (65) 6795-8070  
Email:  
PACIFICRIMinfo.BAND-IT@  
idexcorp.com

#### **Latin American Sales Office**

Tel: (52) 55 5825-8502  
Fax: (52) 55 5825-8502  
Email:  
LAinfo.BAND-IT@idexcorp.com  
**Japan Sales Office**  
Tel: (81) 90 2917 8463  
Email:  
BID.Japaninfo.BAND-IT@  
idexcorp.com

#### **China Suzhou Operations**

Tel: (86) 512 6283-3000  
Fax: (86) 512 6283-3928  
Email:  
BIDChina.BAND-IT@  
idexcorp.com  
Website  
www.band-it.com.cn

# TABLE OF CONTENTS



- Band & Buckle**.....5
  - 201 SS Band, Giant Band, Scru-Lok Buckles.....6
  - VALU-STRAP™, VALU-STRAP™ Plus, Valuband.....6
  - Valu-clip, Galvanized Band & Buckle.....7
  - 304 SS Band, 316 SS Band, 316 SS Buckle & Clips.....8
  - 317L Band, Alloy 400 Band & Buckle, All Purpose Band.....9
  - Band&BuckleKit.....10
  - Roll Band w/COLOR-IT®.....10
  - BAND-FAST®.....11
  - Ultra-Lok® Banding System.....12
- Preformed Clamps**.....15
  - Ultra-Lok®.....15
  - Junior® Smooth.....16
  - Center Punch.....18
- Cable Ties**.....20
  - Tie-Lok®.....20
  - Multi-Lok, Ultra-Lok®.....21
  - Ball-Lok.....22
  - Ball-Lok™.....23
  - BAND-IT® Ties.....24
- Identification**.....26
  - Identification.....26
- Mounting**.....28
  - Mounting Hardware.....28
  - Mounting Brackets.....29
- SIGNFIX**.....30
  - Extrusions.....30
- Adjustable Clamping Systems**.....31
  - Worm Gear.....31
  - Scru-Band & Scru-Seal.....31
- Tools**.....32
  - Hand Tools.....32
  - Power Tools.....36
- Applications**.....8
  - Electrical Applications.....38
  - Cable Restraint Solutions.....40
- Certifications & Definitions**.....44
- Metals Data**.....46

# Banding Applications



## General Use

### BAND-IT Band

- 201 SS, bright annealed finish with a combination of high strength and quality appearance
- Offers good resistance to oxidation and many moderate corrosive agents
- EASY SCALE - imprint on the band to quickly determine band length
- Durable plastic tote dispensers available

### Giant Band

- Our widest and thickest band
- Available in 201 SS bright annealed
- Application Tools: C00369 (for 3/4" band only), and G40269

### VALU-STRAP™, VALU-STRAP Plus™, and Valuband

- Economical band suitable for light duty applications
- Thickness: 0.015", 0.020", 0.025"
- Application Tools: C00169, C00369, C07569, C08569, C40099 and J02069

### Galvanized Carbon Steel Band

- Utilized for low cost and non corrosive applications
- Good strength
- Application Tools: C00169, C00369, C07569, C08569, and C40099

## Corrosion Resistant

### 304 Stainless Steel Band

- Band suitable for light duty applications
- Good corrosion resistance in fresh water and industrial atmospheres
- Application Tools: C00169, C00369, C07569, C08569, and C40099

### 316 Coated & Uncoated Stainless Steel Band

- Superior corrosion resistance in typical atmospheres and fresh water
- Coated band can be used in salt spray applications. Available with a non-toxic polymer coating (PPA 571) that produces low smoke and is halogen free
- Application Tools for coated: C07569, C08569, and C40099
- Application Tools for uncoated: C00169, C00369, C07569, C08569, and C40099

### 317L Stainless Steel Band

- Superior corrosion resistance in industrial and marine atmospheres, salt water, and mild chemicals
- Application Tools: C00169, C00369, and C40099

### Alloy 400 Band

- Superior corrosion resistance in marine, salt water, and harsh chemical environments
- Application Tools: C00169, C00369, C07569, C08569 and C40099

## Special Purpose

### All Purpose Band

- Evenly spaced holes allow fastening with screw or nut and bolt
- Available with a non-toxic polymer coating (PPA 571) that produces low smoke and is halogen free

### COLOR-IT®

- 12 stocked colors
- Speciality colors available upon request (minimum quantity applies)

### Ultra-Lok® Banding System

- Designed for quick installation, highest clamping force and gap-free inside diameter.
- 201 1/4 hard SS band provides greater material strength allowing tighter clamps and can be double wrapped for additional strength

# General Use Band & Buckle

## Type 201 Stainless Steel

This is the standard choice of BAND-IT products, offering very high strength, clean appearance and good resistance to oxidation and weathering. This non-magnetic material is the choice for municipal and industrial markets.

### BAND-IT® Band 201 Stainless Steel

Part No.	Material	Width		Thickness		Average Breaking Strength (lbs)	Package Quantity	Weight		Application Tools
		in	mm	in	mm			lbs	kg	
<b>201 Stainless Steel BAND-IT® Band</b>										
C20299	201 SS	1/4	6.4	0.020	0.51	500	100/Roll	1.7	0.7	C00169 C00369 C07569* C08569* C40099 J02069*
C20399	201 SS	3/8	9.6	0.025	0.64	900	100/Roll	3.2	1.5	
C203Y9	201 SS	3/8	9.6	0.025	0.64	900	Yellow Tote 100/Roll	3.6	1.6	
C20499	201 SS	1/2	12.7	0.030	0.76	1500	100/Roll	5.1	2.3	
C204B9	201 SS	1/2	12.7	0.030	0.76	1500	Blue Tote 100/Roll	5.5	2.5	
C20599	201 SS	5/8	15.8	0.030	0.76	1875	100/Roll	6.4	2.9	
C205G9	201 SS	5/8	15.8	0.030	0.76	1875	Green Tote 100/Roll	6.8	3.1	
C20699	201 SS	3/4	19.1	0.030	0.76	2250	100/Roll	7.7	3.5	
C206R9	201 SS	3/4	19.1	0.030	0.76	2250	Red Tote 100/Roll	8.2	3.7	
<b>BAND-IT® Buckle Ear-Lokt Style</b>										
C25299**	201 SS	1/4	6.4				100/Box	0.3	0.1	
C25399	201 SS	3/8	9.6				100/Box	0.8	0.4	
C25499	201 SS	1/2	12.7				100/Box	2.1	1.0	
C25599	201 SS	5/8	15.8				100/Box	2.4	1.1	
C25699	201 SS	3/4	19.1				100/Box	3.7	1.7	

\*The J02069 can be used with 3/8" maximum width product. C07569 / C08569 tools for use on max 0.025" (0.63mm) thickness

\*\* Clip Style

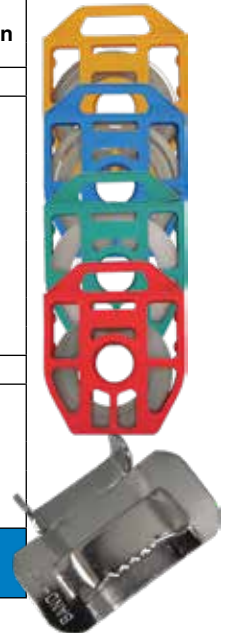

## Giant Band 201 Stainless Steel

Part No.	Material	Width		Thickness		Average Breaking Strength (lbs)	Package Quantity	Weight		Finish	Application Tools
		in	mm	in	mm			lbs	kg		
<b>Giant Band</b>											
G43099*	201 SS	3/4	19.1	0.044	1.10	3300	100/Roll	11.6	5.4		C00369 G40269
G43199	201 SS	1	25.4	0.044	1.10	4400	100/Roll	13.7	6.4		G40269
G43299	201 SS	1-1/4	31.8	0.044	1.10	5500	100/Roll	17.2	8.0		
<b>Giant Buckle Ear-Lokt Style</b>											
G44099	201 SS	3/4	19.1				25/Box	1.8	0.8		
G44199	201 SS	1	25.4				25/Box	2.4	1.1		
G44299	201 SS	1-1/4	31.8				25/Box	3.2	1.4		

\*C00369 tool to be used for 3/4"

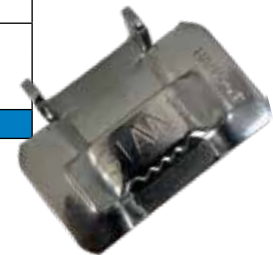

## Scru-Lokt Buckle Stainless Steel

Part No.	Material	Width		Package Quantity	Weight		Application Tools
		in	mm		lbs	kg	
<b>Stainless Steel Scru-Lokt Buckle</b>							
C72099	301 SS 1/4 Hard	1/4	6.4	50/Box	0.3	0.1	Hex Key
C72299	301 SS 1/4 Hard	3/8	9.6	50/Box	0.5	0.2	
C72499	301 SS 1/4 Hard	1/2	12.7	25/Box	0.5	0.2	
C72599	201 SS	5/8	15.8	25/Box	0.8	0.4	
C72699	201 SS	3/4	19.1	25/Box	0.9	0.4	

BAND-IT reserves the right to substitute material with equal or better corrosion resistance and/or mechanical specifications.

# General Use Band & Buckle

## Type 200-300 Stainless Steel

Also known as Value Series Stainless steel - Typically non-magnetic, this economy steel is suitable for light duty applications when the benefits of stainless steel are required.

### VALU-STRAP™ Band Stainless Steel

Part No.	Material	Width		Thickness		Average Breaking Strength (lbs)	Package Quantity	Weight		Application Tools
		in	mm	in	mm			lbs	kg	
<b>VALU-STRAP™</b>										
C13399	200/300 SS	3/8	9.6	0.015	0.38	450	100'/Roll	2.2	1.0	C00169
C13499	200/300 SS	1/2	12.7	0.015	0.38	600	100'/Roll	2.9	1.3	C00369
C13599	200/300 SS	5/8	15.8	0.015	0.38	750	100'/Roll	3.6	1.7	C07569
C13699	200/300 SS	3/4	19.1	0.015	0.38	900	100'/Roll	4.4	2.0	C08569 C40099 J02069*

\*The J02069 can be used with 3/8" maximum width product.



### VALU-STRAP™ Plus Band Stainless Steel

Part No.	Material	Width		Thickness		Average Breaking Strength (lbs)	Package Quantity	Weight		Application Tools
		in	mm	in	mm			lbs	kg	
<b>VALU-STRAP™ Plus</b>										
C18189	200/300 SS	1/2	12.7	0.020	0.51	850	100'/Roll	3.8	1.7	C00169
C17199	200/300 SS	5/8	15.8	0.020	0.51	1000	100'/Roll	5.6	2.6	C00369
C16189	200/300 SS	3/4	19.1	0.020	0.51	1275	100'/Roll	5.7	2.5	C07569 C08569 C40099 J02069*

\*The J02069 can be used with 3/8" maximum width product).

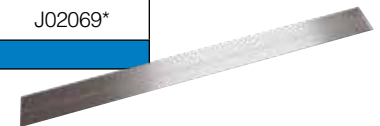

### Valuband Stainless Steel

Part No.	Material	Width		Thickness		Average Breaking Strength (lbs)	Package Quantity	Weight		Application Tools
		in	mm	in	mm			lbs	kg	
<b>Valuband</b>										
C14499	200/300 SS	1/2	12.7	0.025	0.64	1000	100'/Roll	4.5	2.0	C00169
C14599	200/300 SS	5/8	15.8	0.025	0.64	1250	100'/Roll	5.6	2.6	C00369
C14699	200/300 SS	3/4	19.1	0.025	0.64	1590	100'/Roll	6.7	3.0	C07569
C14899	200/300 SS	1/2	12.7	0.025	0.64	1000	200'/Roll	9.0	4.0	C08569
C14999	200/300 SS	5/8	15.8	0.025	0.64	1250	200'/Roll	11.2	5.2	C40099
C15099	200/300 SS	3/4	19.1	0.025	0.64	1590	200'/Roll	13.4	6.0	

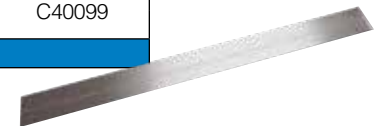

BAND-IT reserves the right to substitute material with equal or better corrosion resistance and/or mechanical specifications.

## General Use Band & Buckle

### Stainless Steel Valucлип

Part No.	Material	Width		Package Quantity	Weight	
		in	mm		lbs	kg
<b>Valucлип</b>						
C15399	200/300 SS	3/8	9.6	100/Box	0.6	0.3
C15499	200/300 SS	1/2	12.7	100/Box	1.1	0.5
C15599	200/300 SS	5/8	15.8	100/Box	1.2	0.5
C15699	200/300 SS	3/4	19.1	100/Box	2.1	0.9



### Stainless Steel Clip

Part No.	Material	Width		Package Quantity	Weight	
		in	mm		lbs	kg
<b>Stainless Steel Clip</b>						
C25299	200/300 SS	1/4	6.4	100/Box	0.3	0.1
L15499	200/300 SS	1/2	12.7	100/Box	1.5	0.7
L15599	200/300 SS	5/8	15.8	100/Box	1.8	0.8
L15699	200/300 SS	3/4	19.1	100/Box	2.6	1.2



### Galvanized Carbon Steel "GCS"

Carbon steel which has been electro galvanized. This is an economical choice offering medium strength.

### Galvanized Carbon Steel Band

Part No.	Material	Width		Thickness	Average Breaking Strength (lbs)	Package Quantity	Weight		Application Tools	
		in	mm				lbs	kg		
<b>Galvanized Carbon Steel Band</b>										
C30499	GCS	1/2	12.7	0.03	0.762	1125	100'/Roll	5.1	2.4	C00169 C00369 C07569 C08569 C40099 J02069*
C30599	GCS	5/8	15.8	0.03	0.762	1405	100'/Roll	6.4	3.0	
C30699	GCS	3/4	19.1	0.03	0.762	1690	100'/Roll	7.7	3.6	

\*The J02069 can be used with 3/8" maximum width product.



### Galvanized Carbon Steel Buckle

Part No.	Material	Width		Package Quantity	Weight	
		in	mm		lbs	kg
<b>Galvanized Carbon Steel Ear-Lokt Buckle</b>						
C35499	GCS	1/2	12.7	100/Box	2.1	1.0
C35599	GCS	5/8	15.8	100/Box	2.4	1.1
C35699	GCS	3/4	19.1	100/Box	3.7	1.7



BAND-IT reserves the right to substitute material with equal or better corrosion resistance and/or mechanical specifications.

# Corrosion Resistant Band & Buckle

## Type 304 Stainless Steel Band

This alloy will provide a very good corrosion resistance in fresh water and industrial atmospheres. Often selected for light duty applications in food processing, chemical, power transmission and cable management.

Part No.	Material	Width		Thickness		Average Breaking Strength (lbs)	Package Quantity	Weight		Application Tools
		in	mm	in	mm			lbs	kg	
<b>304 Stainless Steel Band</b>										
C91399	304 SS	3/8	9.6	0.020	0.51	600	200'/Roll	5.9	2.7	C00169 C00369 C07569 C08569 C40099 J02069*
C91499	304 SS	1/2	12.7	0.020	0.51	850	200'/Roll	7.6	3.4	
C91599	304 SS	5/8	15.8	0.020	0.51	1000	200'/Roll	9.5	4.3	
C91699	304 SS	3/4	19.1	0.020	0.51	1275	200'/Roll	11.3	5.0	

\*The J02069 can be used with 3/8" maximum width product.



## Type 316 Stainless Steel Band (coated & uncoated)

This alloy provides superior corrosion resistance in fresh water and typical atmospheres and is non-magnetic. Ideal for food process, chemical / agricultural hose assemblies, marine splash zones and some acidic environments.

Part No.	Material	Width		Thickness		Average Breaking Strength (lbs)	Package Quantity	Weight		Application Tools
		in	mm	in	mm			lbs	kg	
<b>316 Stainless Steel Band Coated</b>										
AE4339	316 SS	3/8	9.6	0.048**	1.22**	505	82.5'/Roll	2.6	1.2	C07569 C08569 C40069
AE4349	316 SS	1/2	12.7	0.048**	1.22**	670	82.5'/Roll	3.5	1.6	
AE4359	316 SS	5/8	15.8	0.048**	1.22**	840	82.5'/Roll	4.4	2.0	
AE4369	316 SS	3/4	19.1	0.048**	1.22**	1000	82.5'/Roll	5.3	2.4	
**Material thickness includes PPA 571 coating - Base material thickness is 0.015"										
<b>316 Stainless Steel Band Uncoated</b>										
C40299	316 SS	1/4	6.4	0.020	0.51	400	100'/Roll	2.0	0.9	C00169 C00369 C07569* C08569* C40099 J02069*
C40399	316 SS	3/8	9.6	0.025	0.64	750	100'/Roll	3.5	1.6	
C40499	316 SS	1/2	12.7	0.030	0.76	1200	100'/Roll	4.9	2.2	
C404B9	316 SS	1/2	12.7	0.030	0.76	1200	Blue Tote 100'/Roll	5.6	2.6	
C40599	316 SS	5/8	15.8	0.030	0.76	1500	100'/Roll	6.2	2.8	
C405G9	316 SS	5/8	15.8	0.030	0.76	1500	Green Tote 100'/Roll	6.9	3.1	
C40699	316 SS	3/4	19.1	0.030	0.76	1800	100'/Roll	7.5	3.4	
C406R9	316 SS	3/4	19.1	0.030	0.76	1800	Red Tote 100'/Roll	8.2	3.7	

\*The J02069 can be used with 3/8" maximum width product. C07569 / C08569 tools for use on max 0.025" (0.63mm) thickness



## 316 Stainless Steel Ear-Lokt Buckle

Part No.	Material	Width		Package Quantity	Weight	
		in	mm		lbs	kg
<b>316 Stainless Steel Ear-Lokt Buckle</b>						
C45299**	316 SS	1/4	6.4	100/Box	0.3	0.1
C45399	316 SS	3/8	9.6	100/Box	0.8	0.4
C45499	316 SS	1/2	12.7	100/Box	2.1	1.0
C45599	316 SS	5/8	15.8	100/Box	2.4	1.1
C45699	316 SS	3/4	19.1	100/Box	3.7	1.7

\*\* Clip Style

## 316 Stainless Steel Clip

Part No.	Material	Width		Package Quantity	Weight	
		in	mm		lbs	kg
<b>316 Stainless Steel Clip</b>						
AE4529	316 SS	1/4	6.4	100/Box	0.3	0.1
AE4539	316 SS	3/8	9.6	100/Box	0.6	0.3
AE4549	316 SS	1/2	12.7	100/Box	1.0	0.4
AE4559	316 SS	5/8	15.8	100/Box	1.1	0.5
AE4569	316 SS	3/4	19.1	100/Box	1.3	0.6



# Corrosion Resistant Band & Buckle

## Type 317L Stainless Steel Band

This alloy has superior corrosion resistance and is typically used to wrap bleach drums in the pulp and paper mills. The "L" indicates a low carbon content, which significantly improves its welding characteristics.

Subject to extended lead time and minimum order quantities. Call for quotes.

Part No.	Material	Width		Thickness		Average Breaking Strength (lbs)	Package Quantity	Weight		Application Tools
		in	mm	in	mm			lbs	kg	
<b>317L Band</b>										
C41399	317L 1/4 Hard SS	3/8	9.6	0.030	0.76	1290	300'/Roll	11.9	5.3	C00169 C00369 C40099
C42499	317L 1/4 Hard SS	1/2	12.7	0.020	0.51	1160	300'/Roll	10.2	4.6	
C41499	317L 1/4 Hard SS	1/2	12.7	0.030	0.76	1725	300'/Roll	15.9	7.2	
C41599	317L 1/4 Hard SS	5/8	15.8	0.030	0.76	2150	300'/Roll	19.9	9.0	
C41699	317L 1/4 Hard SS	3/4	19.1	0.030	0.76	2580	300'/Roll	23.9	10.8	



## Alloy 400 Band

This is the material of choice for submerged marine and harsh chemical applications.

Subject to extended lead time and minimum order quantities. Call for quotes.

Part No.	Material	Width		Thickness		Average Breaking Strength (lbs)	Package Quantity	Weight		Application Tools
		in	mm	in	mm			lbs	kg	
<b>Alloy 400 Band</b>										
C80399	Alloy 400 Band	3/8	9.6	0.025	0.64	630	100'/Roll	3.7	1.7	C00169
C80499	Alloy 400 Band	1/2	12.7	0.030	0.76	1050	100'/Roll	5.1	2.4	C00369
C80599	Alloy 400 Band	5/8	15.8	0.030	0.76	1310	100'/Roll	7.7	3.5	C40099
C80699	Alloy 400 Band	3/4	19.1	0.030	0.76	1595	100'/Roll	7.7	3.6	J02069*



\*The J02069 can be used with 3/8" maximum width product.

## Alloy 400 Buckle

Subject to extended lead time and minimum order quantities. Call for quotes.

Part No.	Material	Width		Package Quantity	Weight	
		in	mm		lbs	kg
<b>Alloy 400 Buckle</b>						
C85399	Alloy 400	3/8	9.6	100/Box	0.8	0.4
C85499	Alloy 400	1/2	12.7	100/Box	2.1	1.0
C85599	Alloy 400	5/8	15.8	100/Box	2.4	1.0
C85699	Alloy 400	3/4	19.1	100/Box	3.7	1.7



## Special Purpose Band

### All Purpose Band (coated & uncoated)

Part No.	Material	Width		Thickness		Diameter of Hole		Package Quantity	Weight	
		in	mm	in	mm	in	mm		lbs	kg
<b>All Purpose Band PPA571 Coated</b>										
AE4759	316 SS	1/2	12.7	0.050	1.3	0.19	5	82.5'/Roll	3.1	1.4
AE4769	316 SS	3/4	19.1	0.050	1.3	0.27	7	82.5'/Roll	5.3	2.4
AE4779	316 SS	1	25.4	0.050	1.3	0.31	8	82.5'/Roll	7.3	3.3
NOTE: Material thickness includes PPA 571 coating - Base material thickness is 0.030"										
<b>All Purpose Band Uncoated</b>										
AE4259	316 SS	1/2	12.7	0.030	0.76	0.19	5	82.5'/Roll	3.1	1.4



BAND-IT reserves the right to substitute material with equal or better corrosion resistance and/or mechanical specifications.

# General Use Band & Buckle

## Roll Band with COLOR-IT®

Part No.	Material	Width		Thickness		Package Quantity	Weight		Color	RAL#	Application Tools
		in	mm	in	mm		lbs	kg			
<b>Roll Band with COLOR-IT® - Polyester</b>											
C144C9-P000	201/301 SS	1/2	12.7	0.025	0.64	100'/Roll	5.1	2.3	White	9016	C00169 C00369 C07569* C08569* C40099
C144C9-P100	201/301 SS	1/2	12.7	0.025	0.64	100'/Roll	5.1	2.3	Red	3001	
C144C9-P200	201/301 SS	1/2	12.7	0.025	0.64	100'/Roll	5.1	2.3	Orange	2008	
C144C9-P300	201/301 SS	1/2	12.7	0.025	0.64	100'/Roll	5.1	2.3	Yellow	1018	
C144C9-P302	201/301 SS	1/2	12.7	0.025	0.64	100'/Roll	5.1	2.3	Tan	1001	
C144C9-P400	201/301 SS	1/2	12.7	0.025	0.64	100'/Roll	5.1	2.3	Green	6032	
C144C9-P500	201/301 SS	1/2	12.7	0.025	0.64	100'/Roll	5.1	2.3	Blue	5002	
C144C9-P550	201/301 SS	1/2	12.7	0.025	0.64	100'/Roll	5.1	2.3	Lt. Blue	5012	
C144C9-P600	201/301 SS	1/2	12.7	0.025	0.64	100'/Roll	5.1	2.3	Purple	4008	
C144C9-P700	201/301 SS	1/2	12.7	0.025	0.64	100'/Roll	5.1	2.3	Gray	7036	
C144C9-P800	201/301 SS	1/2	12.7	0.025	0.64	100'/Roll	5.1	2.3	Brown	8002	
C144C9-P900	201/301 SS	1/2	12.7	0.025	0.64	100'/Roll	5.1	2.3	Black	9004	
C206C9-P900	201/301 SS	3/4	19.1	0.030	0.76	100'/Roll	7.6	3.4	Black	9004	
<b>Ear-Lokt Buckles with COLOR-IT® - Zinc</b>											
BKEC-A08-Z900	201/301 SS	1/2	12.7			100/Box	1.7	0.8	Black	9004	
BKEC-A12-Z900	201/301 SS	3/4	19.1			100/Box	3.5	1.6	Black	9004	

\* C07569 / C08569 tools for use on max 0.025" (0.63mm) thickness



Colored Roll Band in Tote

C00169 Standard Banding Tool



C07569 Bantam Tool



### BAND-IT® Band & Buckle Kit C27699

- Basic starter kit in a polyethylene case

C27699 - 1/2" band & buckle kit: 1- C00169, 1- C20499, 1- C25499 and 1- C72499 (kit weight - 17.2lbs, 7.8kg)

# BAND-FAST®

BAND-FAST® is a pre-cut band with smoother edges that creates a safer and more efficient working environment with decreased installation labor.



## BAND-FAST® Precut and Assembled with Ear-Lokt Buckle

Part No.	Material	Width		Thickness		Finished Length		Max. Dia. Single Wrap		Max. Dia. Double Wrap		Package Quantity	Application Tools
		in	mm	in	mm	in	mm	in	mm	in	mm		
<b>BAND-FAST® Precut and Assembled with Ear-Lokt Buckle</b>													
BFES-A1230-024	201 SS	3/4	19.1	0.030	0.76	24	609	5	127	2.5	64	25/Box	C00169 C00369 C40099
BFES-A1230-034	201 SS	3/4	19.1	0.030	0.76	34	863	8	203	4	102	25/Box	
BFES-A1230-048	201 SS	3/4	19.1	0.030	0.76	48	1219	12	305	6	152	25/Box	
BFES-A1230-069	201 SS	3/4	19.1	0.030	0.76	69	1752	18	457	9	229	25/Box	
BFES-A1230-090	201 SS	3/4	19.1	0.030	0.76	90	2286	24	610	12	305	15/Box	

## BAND-FAST® Open End with Center Punch Clip

SS Part No.	Width		Thickness		Length**		Inside Diameter Single Wrap		Inside Diameter Double Wrap		Pkg Qty	Application Tools
	in	mm	in	mm	in	mm	in	mm	in	mm		
<b>BAND-FAST® Open End with Center Punch Clip</b>												
O325S9	3/8	9.6	0.020	0.51	24.0	610	6	152	3	76	100/Box	T30069
O16S99	5/8	15.8	0.020	0.51	31.0	787	8	203	4	102	50/Box	

NOTE: Take the object circumference and add 6" to grip with the tool (2 X circumference for double wrap plus 6" for tail insertion).

## BAND-FAST® Precut and Assembled with Clip

Part No.	Material	Width		Thickness		Finished Length		Max. Dia. Single Wrap		Max. Dia. Double Wrap		Package Quantity	Weight		Application Tools
		in	mm	in	mm	in	mm	in	mm	in	mm		lbs	kg	
<b>BAND-FAST® Precut and Assembled with Clip</b>															
L20399	201 SS	1/4	6.4	0.020	0.51	10	254	2	50	not suggested		100/Box	2.2	0.9	C00169 C00369 C07569* C40099 J02069*
L20499	201 SS	1/4	6.4	0.020	0.51	16	406	3-1/2	88	1-1/2	38	100/Box	3.1	1.4	
L20799	201 SS	1/4	6.4	0.020	0.51	19	482	5	127	2-1/2	63	100/Box	3.5	1.6	
L20899	201 SS	1/4	6.4	0.020	0.51	26	660	7	177	3-1/2	88	100/Box	4.6	2.1	
L21099	201 SS	1/4	6.4	0.020	0.51	34	863	9	228	4-1/2	114	100/Box	5.6	2.6	
L22199	201 SS	3/8	9.6	0.025	0.64	16	406	3-1/2	88	1-1/2	38	100/Box	6.2	2.8	
L22999	201 SS	3/8	9.6	0.025	0.64	44	1117	12	305	6	152	25/Box	3.6	1.6	
L28499	201 SS	3/4	19.1	0.030	0.76	24	609	6	152	3	76	50/Box	10.9	4.9	
L28899	201 SS	3/4	19.1	0.030	0.76	37	940	10	254	5	127	25/Box	7.6	3.5	
L29099	201 SS	3/4	19.1	0.030	0.76	50	1270	14	355	7	177	25/Box	9.7	4.4	
L29299	201 SS	3/4	19.1	0.030	0.76	62	1575	18	457	9	228	25/Box	11.6	5.3	

\* The J02069 can be used with 3/8" maximum width product \*C07569 for use on max 0.025" (0.63mm) thickness

# ULTRA-LOK® Clamping System



3/4" Ultra-Lok® Free End Band with Buckle forms a low profile, tamper proof lock.

## Ultra-Lok® Free End Banding System

Designed for quick installation, highest clamping force and gap-free inside diameter. The best choice for demanding applications!

- Apply 3-5 times faster than band and buckle hand tools
- Unique lock formed under full tension maximizing tightness
- 201 SS band provides greater material strength allowing tighter clamps and can be double wrapped for additional strength
- 3/4" band available in plastic totes
- Application Tool: UL4000-D cordless



1/2" Ultra-Lok® Free End Band with Buckle



3/4" Ultra-Lok® Tote



UL4000-D

**Longer charge and battery life.** Now powered with a Lithium-ion battery, the UL4000-D battery charge lasts longer with consistent peak performance through the life of the battery. In addition, the UL4000-D uses a mechanical clutch and predetermined torque settings to provide a consistent tightness that eliminates assembly guesswork.

## ULTRA-LOK® Tool with Accessories

Part No.	Description
<b>Ultra-Lok® Tool with Accessories</b>	
UL4000-D	ULTRA-LOK® tool comes fully assembled in a custom protective case made with impact resistant HDPE thermoplastic. Included with the UL4000-D: 1- spare 18 volt Lithium-ion battery, 1- battery charger, tool lubrication/assembly tool kit and operators manuals.
M09387	1/2" shear plate (SOLD SEPARATELY) is compatible with the UL 4000-D,C,B, and UL4000, to convert from 3/4" ULTRA-LOK® to 1/2" ULTRA-LOK® Clamp systems.
UL4199	UL Safety Belt (SOLD SEPARATELY) is compatible with the UL 4000-D,C,B, and UL4000.

## ULTRA-LOK® Clamping System

Part No.	Material	Width		Thickness		Length		Single Wrap		Double Wrap		Package Quantity	Weight		Application Tools
		in	mm	in	mm	in	mm	in	mm	in	mm		lbs	kg	
<b>Ultra-Lok® Band</b>															
UL1018**	201 SS	1/2	12.7	0.030	0.76	18	457	3	76	not suggested		50/Box	4.1	1.9	UL4000D
UL1024**	201 SS	1/2	12.7	0.030	0.76	24	610	5	127	2.5	64	50/Box	5.3	2.4	
UL1032**	201 SS	1/2	12.7	0.030	0.76	32	813	7	178	3.5	89	50/Box	7.2	3.3	
UL1046**	201 SS	1/2	12.7	0.030	0.76	46	1168	11	280	5.5	140	25/Box	5.9	2.7	
UL1070**	201 SS	1/2	12.7	0.030	0.76	70	1778	18	457	9	229	25/Box	8.5	3.9	
UL1096**	201 SS	1/2	12.7	0.030	0.76	96	2438	25	635	12.5	318	25/Box	11.2	5.1	
UL1116**	201 SS	1/2	12.7	0.030	0.76	116	2946	31	787	15.5	394	25/Box	13.3	6.0	
UL2024	201 SS	3/4	19.1	0.030	0.76	24	610	5	127	not suggested		25/Tote	4.1	1.9	
UL2032	201 SS	3/4	19.1	0.030	0.76	32	813	7	178	3.5	89	19/Tote	4.3	2.0	
UL2036	201 SS	3/4	19.1	0.030	0.76	36	914	8	252	4	102	33/Tote	8.2	3.7	
UL2044	201 SS	3/4	19.1	0.030	0.76	44	1118	11	267	5.5	140	27/Tote	8.2	3.7	
UL2048	201 SS	3/4	19.1	0.030	0.76	48	1219	12	305	6	153	25/Tote	8.2	3.7	
UL2052	201 SS	3/4	19.1	0.030	0.76	52	1321	13	330	6.5	165	23/Tote	8.2	3.7	
UL2060	201 SS	3/4	19.1	0.030	0.76	60	1524	15	381	7.5	191	20/Tote	8.2	3.7	
UL2068	201 SS	3/4	19.1	0.030	0.76	68	1727	17	445	8.5	216	17/Tote	8.2	3.7	
UL2076	201 SS	3/4	19.1	0.030	0.76	76	1930	20	508	10	254	15/Tote	8.2	3.7	
UL2084	201 SS	3/4	19.1	0.030	0.76	84	2134	22	559	11	280	14/Tote	8.2	3.7	
UL2092	201 SS	3/4	19.1	0.030	0.76	92	2337	24	622	12	305	13/Tote	8.2	3.7	
UL2120	201 SS	3/4	19.1	0.030	0.76	120	3048	32	826	16	407	10/Tote	8.2	3.7	
UL2150	201 SS	3/4	19.1	0.030	0.76	150	3810	41	1029	20.5	508	8/Tote	8.2	3.7	
UL2175	201 SS	3/4	19.1	0.030	0.76	175	4445	48	1232	24	610	6/Tote	8.2	3.7	
<b>Ultra-Lok® Buckles</b>															
UB2549	201 SS	1/2	12.7									100/Box	3.7	1.7	
UB2569	201 SS	3/4	19.1									100/Box	3.7	1.7	

\*\* 1/2" Bands will require M09387 for UL4000 and UL9010 Tool.

3/4" width band lengths 36" or longer in 100' Totes; 34" or less in 50' Totes.

### UL4000-D Ultra-Lok® Cordless Tool

- Applies 1/2" & 3/4" Ultra-Lok preformed clamps or Band and Buckle
- Ultra-Lok clamps can be applied four times faster than conventional clamps
- Supplied with spare battery and charger with Automatic Battery Tune-Up feature
- Locks under full tension
- Adjustable speed and torque
- Consistent, repeatable tensioning
- Available in 110 or 220 volt power source
- Ideal for field repairs

UL4000-D



\* For 1/2" applications, must use M09387 1/2" Shear Plate.

# Preformed Clamps

**Chemical Plants, Food Processing, Plant Maintenance, Government, Communications & Utility**

**Engineered Fastening and Bundling Systems for Extreme Conditions**

**Products:** Ultra-Lok®, Junior® Smooth ID and Center Punch.

**Benefits:**

- Superior performance in extreme temperatures, chemical exposure, salt spray conditions and UV light exposure
- Low inventory requirements
- Multiple preformed clamp solutions for various environments, markets and industries
- Hand and production application tools
- Permanent and secure locking mechanisms
- Reliable and efficient installation tools
- Low installed cost
- High quality materials that meets ASTM standards
- Quality certified manufacturing process management - ISO9001 with TS 16949

**Commonly Used Hose Applications:**

- Air/Multi-Purpose
- Food Handling
- Lay Flat
- Petroleum Drop, Vapor, Discharge and Suction
- Water - General Purpose, Suction, Discharge
- Chemical Hose - Plastic and Rubber Lined



**Preformed Clamps Chart**

<b>Good</b> Center Punch	<b>Better</b> Junior Smooth ID	<b>Best</b> Ultra-Lok®
<b>Preformed Clamps</b>		
2 Material choices	3 Material choices	201 1/4 hard stainless steel
Locks using conical punch	Vibration resistant lip wrap lock	Superior vibration resistance, locks under full tension
Manufactured with stainless steel buckles to provide greater locking strength	Smooth ID design reduces leak path	Smooth ID design reduces leak path
Sizes from 13/16" to 8" available	Sizes from 13/16" to 8" available	Patented lock design, sizes from 1 1/2" to 9" available, longer length open end clamps also available
Applied with choice of 2 hand tools, or one air production tool	Applied with a choice of 1 hand tool, or 2 air production tools	Applied with portable battery powered tool

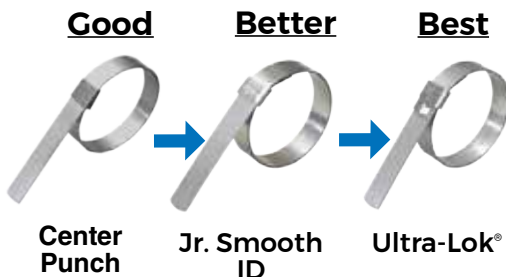

**CAUTION:** BAND-IT recommends that hose assemblies are tested per established industry test methods and tagged for your safety prior to use.

# ● ULTRA-LOK® Clamping System



## Preformed Clamping Systems

Designed for quick installation, highest clamping force and smooth, gap-free inside diameter. The best choice for demanding applications!

- Strongest band clamping system available
- Double wrapped 201SS for superior strength
- Unique lock formed under full tension maximizes tightness
- Thicker buckle is 2-3 times stronger than other preformed clamps
- Smooth inside diameter designed to eliminate leak paths
- Buckle hood protects lock from snags
- Install Ultra-Lok® clamping systems quickly using portable power tools

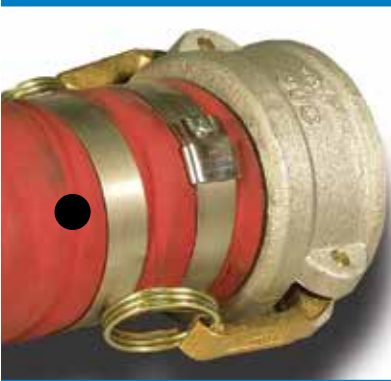

## Preformed Clamps

Part No.	Material	Width		Thickness		Inside Diameter		Package Weight		Pkg Qty	Tools
		In	mm	In	mm	In	mm	Lbs	Kg		
<b>Ultra-Lok® Preformed Clamp</b>											
UL2279	201 SS	3/4	19.1	0.030	0.76	2	50	14.9	6.8	100/Box	
UL2109	201 SS	3/4	19.1	0.030	0.76	2.75	69	9.2	4.2	50/Box	
UL2119	201 SS	3/4	19.1	0.030	0.76	3	76	10.4	4.7	50/Box	
UL2129	201 SS	3/4	19.1	0.030	0.76	3.5	88	10.8	4.9	50/Box	
UL2139	201 SS	3/4	19.1	0.030	0.76	4	101	6.4	2.9	25/Box	
UL2149	201 SS	3/4	19.1	0.030	0.76	4.5	114	7	3.2	25/Box	
UL2159	201 SS	3/4	19.1	0.030	0.76	5	127	7.5	3.4	25/Box	
UL2709	201 SS	3/4	19.1	0.030	0.76	5.25	139	7.3	3.3	25/Box	
UL2169	201 SS	3/4	19.1	0.030	0.76	6	152	8.4	3.8	25/Box	
UL2179	201 SS	3/4	19.1	0.030	0.76	6.5	165	10.2	4.6	25/Box	
UL2189	201 SS	3/4	19.1	0.030	0.76	7	177	9.8	4.4	25/Box	
UL2199	201 SS	3/4	19.1	0.030	0.76	8	203	11.0	5.0	25/Box	
UL2289	201 SS	3/4	19.1	0.030	0.76	9	228	5.1	2.31	10/Box	

# BAND-IT JR<sup>®</sup> Smooth ID



## Preformed Clamping Systems

Wide choice of sizes and materials in a leak resistant design.

- Smooth I.D. Clamps reduce the risk of leaks especially when used on thin walled hoses
- Vibration resistant lip lock design. No hammering or crimping
- Unique buckle nest and smooth ID design reduces leak paths
- Double wrapped steel bands for additional strength
- Various materials for corrosive environments
- Band widths - 1/4", 3/8", 1/2", 5/8" and 3/4"
- Available for hose assemblies up to 9" outside diameter



## Pneumatic and Hand Tools

**S75099 Pneumatic Junior<sup>®</sup> Clamp Application Tool**



**Use with**

*BAND-IT<sup>®</sup> Junior<sup>®</sup> Smooth ID Preformed Clamps*

**S35099 Pneumatic Junior<sup>®</sup> Clamp Automatic Air Tool**



**Use with**

*BAND-IT<sup>®</sup> Junior<sup>®</sup> Smooth ID Preformed Clamps*

**C00269 Junior<sup>®</sup> Preformed Clamp Tool**



**Use with**

*BAND-IT<sup>®</sup> Junior<sup>®</sup> Smooth ID Preformed Clamps*



# BAND-IT JR<sup>®</sup> Smooth ID

## Preformed Clamping Systems

Wide choice of sizes and materials.

Suggested Band Clamp Widths, Rollover Style: Hose ID	Clamp Band Width
<b>Use with Juniors &amp; Junior Smooth Clamps</b>	
<1/2"	3/8"
1/2" - 3/4"	1/2"
3/4" - 2"	5/8"
>2"	3/4"

201 SS* Part No.	316 SS* Part No.	GCS* Part No.	Width		Thickness		Inside Diameter		Package Weight		Package Quantity	Application Tools
			In	mm	In	mm	In	mm	Lbs	Kg		
<b>BAND-IT<sup>®</sup> Junior<sup>®</sup> Smooth ID Clamp</b>												
JS2409	NA	NA	1/4	6.4	0.020	0.51	0.8125	20	2.0	0.9	100/Box	C00169** J00169** C00269 IT2000 S35099 S75099
JS2429	NA	NA	1/4	6.4	0.020	0.51	1.0	25	2.1	1.0	100/Box	
JS2419	NA	NA	1/4	6.4	0.020	0.51	1.375	34	2.5	1.1	100/Box	
JS2529	NA	NA	1/4	6.4	0.020	0.51	1.5	38	2.6	1.2	100/Box	
JS2539	NA	NA	1/4	6.4	0.020	0.51	2.0	50	3.2	1.5	100/Box	
JS2209	NA	NA	1/4	6.4	0.020	0.51	2.5	63	3.7	1.7	100/Box	
JS2569	NA	NA	1/4	6.4	0.020	0.51	2.75	69	3.8	1.7	100/Box	
JS2449	NA	NA	1/4	6.4	0.020	0.51	3	76	4.2	1.9	100/Box	
JS2579	NA	NA	1/4	6.4	0.020	0.51	3.5	88	4.6	2.1	100/Box	
JS2589	NA	NA	1/4	6.4	0.020	0.51	4.0	101	5.3	2.4	100/Box	
JS2599	NA	NA	1/4	6.4	0.020	0.51	4.5	114	5.7	2.6	100/Box	
JS2019	JS4019	JS3019	3/8	9.6	0.025	0.64	0.8125	20	3.6	1.6	100/Box	C00169** J00169** J05069** C00269 IT5000 S35099 S75099
JS2439	NA	JS3439	3/8	9.6	0.025	0.64	1.0	25	3.9	1.8	100/Box	
JS2029	JS4029	JS3029	3/8	9.6	0.025	0.64	1.375	34	5.0	2.3	100/Box	
JS2459	JS4459	JS3459	3/8	9.6	0.025	0.64	2.0	50	5.9	2.7	100/Box	
JS2219	JS4219	JS3219	3/8	9.6	0.025	0.64	2.5	63	6.8	3.1	100/Box	
JS2469	NA	JS3469	3/8	9.6	0.025	0.64	3.0	76	7.5	3.4	100/Box	
JS2559	JS4559	JS3559	3/8	9.6	0.025	0.64	3.5	88	8.6	3.9	100/Box	
JS2489	JS4489	JS3489	3/8	9.6	0.025	0.64	4.0	101	9.5	4.3	100/Box	
JS2039	JS4039	JS3039	1/2	12.7	0.030	0.76	1.0	25	6.5	3.0	100/Box	
JS2049	JS4049	JS3049	1/2	12.7	0.030	0.76	1.25	31	7.2	3.3	100/Box	
JS2319	NA	JS3319	1/2	12.7	0.030	0.76	1.5	38	8.1	3.7	100/Box	
JS2369	NA	JS3369	1/2	12.7	0.030	0.76	1.75	44	8.7	4.0	100/Box	
JS2379	JS4379	JS3379	1/2	12.7	0.030	0.76	2.0	50	9.4	4.3	100/Box	
JS2339	JS4339	JS3339	1/2	12.7	0.030	0.76	2.5	63	10.8	4.9	100/Box	
JS2309	NA	JS3309	1/2	12.7	0.030	0.76	2.75	69	11.3	5.1	100/Box	
JS2349	JS4349	JS3349	1/2	12.7	0.030	0.76	3.0	76	12.2	5.5	100/Box	
JS2479	JS4479	JS3479	1/2	12.7	0.030	0.76	3.5	88	13.6	6.2	100/Box	
JS2499	JS4499	JS3499	1/2	12.7	0.030	0.76	4.0	101	14.9	6.8	100/Box	
JS2059	JS4059	JS3059	5/8	15.8	0.030	0.76	1.5	38	10.4	4.7	100/Box	C00169** J00169** J05069** C00269 S35099 S75099
JS2069	JS4069	JS3069	5/8	15.8	0.030	0.76	1.75	44	11.3	5.1	100/Box	
JS2079	JS4079	JS3079	5/8	15.8	0.030	0.76	2.0	50	12.2	5.5	100/Box	
JS2089	JS4089	JS3089	5/8	15.8	0.030	0.76	2.25	57	13.3	6.0	100/Box	
JS2099	JS4099	JS3099	5/8	15.8	0.030	0.76	2.5	63	13.9	6.3	100/Box	
JS2279	JS4279	JS3279	3/4	19.1	0.030	0.76	2.0	50	14.9	6.8	100/Box	
JS2109	JS4109	JS3109	3/4	19.1	0.030	0.76	2.75	69	9.2	4.2	50/Box	
JS2119	JS4119	JS3119	3/4	19.1	0.030	0.76	3.0	76	9.7	4.4	50/Box	
JS2129	JS4129	JS3129	3/4	19.1	0.030	0.76	3.5	88	10.8	4.9	50/Box	
JS2139	JS4139	JS3139	3/4	19.1	0.030	0.76	4.0	101	6.1	2.8	25/Box	
JS2149	JS4149	JS3149	3/4	19.1	0.030	0.76	4.5	114	6.7	3.0	25/Box	
JS2159	JS4159	JS3159	3/4	19.1	0.030	0.76	5.0	127	7.2	3.3	25/Box	
JS2709	JS4709	JS3709	3/4	19.1	0.030	0.76	5.25	133	7.3	3.3	25/Box	
JS2169	JS4169	JS3169	3/4	19.1	0.030	0.76	6.0	152	8.2	3.7	25/Box	
JS2179	NA	JS3179	3/4	19.1	0.030	0.76	6.5	165	9.2	4.2	25/Box	
JS2189	NA	JS3189	3/4	19.1	0.030	0.76	7.0	177	10.2	4.6	25/Box	
JS2199	NA	JS3199	3/4	19.1	0.030	0.76	8.0	203	11.0	5.0	25/Box	

\* BAND-IT reserves the right to substitute material with equal or better corrosion resistance and/or mechanical specifications

\*\* Junior<sup>®</sup> Adaptors, either J00169 or J05069, must be used with C00169

# Center Punch Clamps



## Preformed Clamping Systems

Designed to meet your specific application requirement.

- Lock with impact from a hammer using a conical punch designed into the tool
- Double wrapped steel bands using 201 Stainless Steel or galvanized carbon steel
- Manufactured with 201 Stainless Steel buckles to provide added locking strength
- Not recommended for use with fittings that may crack as a result of impact or poly fittings
- Install 3/8" and 5/8" width Center Punch clamping systems with the following hand tools: S03869, T30069. The SM1700 Pneumatic Production Tool installs 5/8" clamps without the typical roll up action



## SM1700 Pneumatic Automatic Center Punch Clamp Air Tool

Designed to install BAND-IT® Center Punch 5/8" wide preformed clamps, made from 201 Stainless Steel and Galvanized Carbon Steel. Automatically tensions and cuts off clamp tail.

### Use with

*BAND-IT® Center Punch Preformed Clamps*

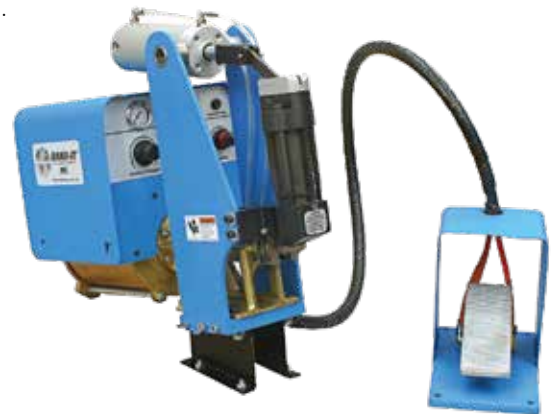

# Center Punch Clamps

## Preformed Clamping Systems

201 SS* Part No.	GCS* Part No.	Width		Thickness		Inside Diameter		Package Weight		Package Quantity	Application Tools
		In	mm	In	mm	In	mm	Lbs	Kg		
<b>Center Punch Clamp 0.025" Thickness</b>											
CP3S99	CP0399	3/8	9.6	0.025	0.64	.8125	20	3.6	1.6	100/Box	S03869 T30069
CP311S	CP3119	3/8	9.6	0.025	0.64	1.375	35	4.6	2.1	100/Box	
CP4S99	CP0499	5/8	15.8	0.025	0.64	1	25	8.3	3.8	100/Box	
CP5S99	CP0599	5/8	15.8	0.025	0.64	1.25	32	8.7	4.0	100/Box	
CP6S99	CP0699	5/8	15.8	0.025	0.64	1.5	38	9.7	4.4	100/Box	
CP7S99	CP0799	5/8	15.8	0.025	0.64	1.75	44	10.6	4.8	100/Box	
CP8S99	CP0899	5/8	15.8	0.025	0.64	2	51	11.5	5.2	100/Box	
CP9S99	CP0999	5/8	15.8	0.025	0.64	2.25	57	12.6	5.7	100/Box	
CP10S9	CP1099	5/8	15.8	0.025	0.64	2.5	64	6.8	3.1	50/Box	
CP11S9	CP1199	5/8	15.8	0.025	0.64	2.75	70	7.3	3.3	50/Box	
CP12S9	CP1299	5/8	15.8	0.025	0.64	3	76	7.7	3.5	50/Box	
CP14S9	CP1499	5/8	15.8	0.025	0.64	3.5	89	8.7	4.0	50/Box	
CP16S9	CP1699	5/8	15.8	0.025	0.64	4	102	4.9	2.2	25/Box	
CP18S9	CP1899	5/8	15.8	0.025	0.64	4.5	114	5.5	2.5	25/Box	
CP20S9	CP2099	5/8	15.8	0.025	0.64	5	127	5.9	2.7	25/Box	
CP24S9	CP2499	5/8	15.8	0.025	0.64	6	152	6.8	3.1	25/Box	
CP26S9	CP2699	5/8	15.8	0.025	0.64	6.5	165	7.1	3.3	25/Box	
CP28S9	CP2899	5/8	15.8	0.025	0.64	7	178	7.4	3.4	25/Box	
CP32S9	CP3299	5/8	15.8	0.025	0.64	8	203	8.2	3.7	25/Box	
<b>Center Punch Clamp 0.030" Thickness</b>											
	PB0699	5/8	15.8	0.030	0.76	1.5	38	9.7	4.4	100/Box	S03869 T30069 SM1700
	PB0799	5/8	15.8	0.030	0.76	1.75	44	10.6	4.8	100/Box	
	PB0899	5/8	15.8	0.030	0.76	2	51	11.5	5.2	100/Box	
	PB0999	5/8	15.8	0.030	0.76	2.25	57	12.6	5.7	100/Box	
	PB1099	5/8	15.8	0.030	0.76	2.5	64	6.8	3.1	50/Box	
	PB1199	5/8	15.8	0.030	0.76	2.75	70	7.3	3.3	50/Box	
	PB1299	5/8	15.8	0.030	0.76	3	76	7.7	3.5	50/Box	
	PB1499	5/8	15.8	0.030	0.76	3.5	89	8.7	4.0	50/Box	
	PB1699	5/8	15.8	0.030	0.76	4	102	4.9	2.2	25/Box	
	PB1899	5/8	15.8	0.030	0.76	4.5	114	5.5	2.5	25/Box	
	PB2099	5/8	15.8	0.030	0.76	5	127	5.9	2.7	25/Box	
	PB2499	5/8	15.8	0.030	0.76	6	152	6.8	3.1	25/Box	
	PB2699	5/8	15.8	0.030	0.76	6.5	165	7.1	3.3	25/Box	
	PB2899	5/8	15.8	0.030	0.76	7	178	7.4	3.4	25/Box	
	PB3299	5/8	15.8	0.030	0.76	8	203	8.2	3.7	25/Box	

\* BAND-IT reserves the right to substitute material with equal or better corrosion resistance and/or mechanical specifications



T30069 Center Punch Tool



Used to apply BAND-IT® 3/8" and 5/8" Center Punch and Galvanized Carbon Steel preformed clamps.

S03869 Center Punch Tool



Versatile ratchet tool applies 3/8" and 5/8" Center Punch Clamps.

# Tie-Lok® Ties

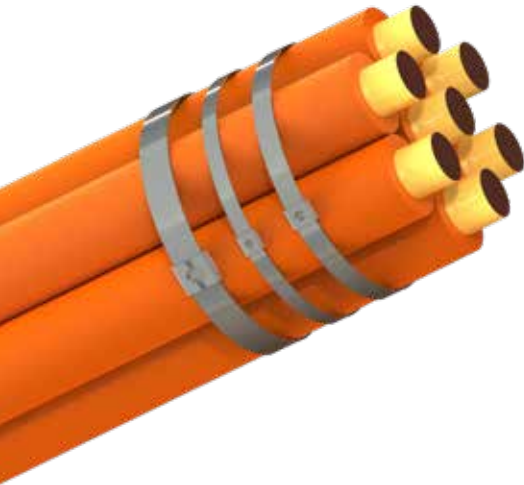

## BAND-IT® Tie-Lok® ties offer a unique dimple lock with a smooth ID and a low profile.

Provides fast, consistent and reliable clamping tension. Used in many industries such as automotive, cable bundling and identification.

- Strong patented dimple lock
- Locks under full tension - no slipback  
Three Widths: 0.177 (4.49mm), 0.25" (6.35mm) and 0.325" (9.6mm)
- Available in type 304 and type 316 Stainless Steel to provide good resistance to mild atmosphere, fresh water, UV rays and extreme environments
- 316 Stainless Steel for extreme environments
- Forms a low profile single wrapped assembly to secure cables, hoses, I.D. Tags, CV Boots, filter bags

Part No.	Material	Width		Length		Thickness		Maximum Diameter Single Wrap		Minimum Loop Tensile Strength (Lbs)	Package Quantity	Application Tools
		In	mm	In	mm	In	mm	In	mm			
<b>Tie-Lok® Tie</b>												
AS2119	304 SS	0.25	6.4	10.0	254	0.015	0.38	2	51	250	100/Bag	A92079 IT1000
AS2129	304 SS	0.25	6.4	16.5	419	0.015	0.38	4	101	250	100/Bag	
AS2139	304 SS	0.25	6.4	22.5	572	0.015	0.38	6	152	250	100/Bag	
AS2149	304 SS	0.25	6.4	29.0	737	0.015	0.38	8	203	250	100/Bag	
AS2159	304 SS	0.25	6.4	35.0	889	0.015	0.38	10	254	250	100/Bag	
AS4119	316 SS	0.25	6.4	10.0	254	0.015	0.38	2	51	250	100/Bag	
AS4129	316 SS	0.25	6.4	16.5	419	0.015	0.38	4	101	250	100/Bag	
AS4139	316 SS	0.25	6.4	22.5	572	0.015	0.38	6	152	250	100/Bag	
AS4149	316 SS	0.25	6.4	29.0	737	0.015	0.38	8	203	250	100/Bag	
AS4159	316 SS	0.25	6.4	35.0	889	0.015	0.38	10	254	250	100/Bag	
AS6219	304 SS	0.375	9.6	7.2	184	0.020	0.51	1.5	40	350	100/Bag	IT6000 TL3800
AS6229	304 SS	0.375	9.6	10.0	254	0.020	0.51	2	51	350	100/Bag	
AS6239	304 SS	0.375	9.6	16.0	406	0.020	0.51	4	101	350	100/Bag	
AS6249	304 SS	0.375	9.6	22.5	572	0.020	0.51	6	152	350	100/Bag	
AS6259	304 SS	0.375	9.6	29.0	737	0.020	0.51	8	203	350	100/Bag	

\* TL3800 to be used with 3/8" only.



Part No.	Material	Width		Length		Thickness		Maximum Diameter Single Wrap		Minimum Loop Tensile Strength (Lbs)	Package Quantity	Application Tools
		In	mm	In	mm	In	mm	In	mm			
<b>Mini Tie-Lok® Tie</b>												
AS2219	304 SS	0.177	4.5	7	165	0.015	0.38	1	25	100	100/Bag	A91079 IT0750
AS2229	304 SS	0.177	4.5	10	254	0.015	0.38	2	51	100	100/Bag	
AS2239	304 SS	0.177	4.5	16	406	0.015	0.38	4	102	100	100/Bag	
AS2249	304 SS	0.177	4.5	22.5	572	0.015	0.38	6	152	100	100/Bag	
AS2259	304 SS	0.177	4.5	29	737	0.015	0.38	8	203	100	100/Bag	
AS4219	316 SS	0.177	4.5	7	165	0.015	0.38	1	25	100	100/Bag	
AS4229	316 SS	0.177	4.5	10	254	0.015	0.38	2	51	100	100/Bag	
AS4239	316 SS	0.177	4.5	16	406	0.015	0.38	4	102	100	100/Bag	
AS4249	316 SS	0.177	4.5	22.5	572	0.015	0.38	6	152	100	100/Bag	
AS4259	316 SS	0.177	4.5	29	737	0.015	0.38	8	203	100	100/Bag	

## Multi-Lok Ties



**BAND-IT® Multi-Lok ties offer a high strength plus vibration resistant benefit. This product is a perfect choice for harsh duty or marine environments.**

- Self-locking ties
- Two widths - 0.276" (7.01mm) and 0.472" (12.0mm)
- Coated with Nylon 11 or uncoated 316 SS styles available
- Fast, easy application
- Install by hand or with a variety of tools
- Unique high strength multiple locking system

Part No	Material	Width		Length		Thickness (Coated/Un-coated Coated)		Maximum Diameter Single Wrap		Minimum Loop Tensile Strength (Lbs)	Package Quantity	Application Tools	
		In	mm	In	mm	In	mm	In	mm				
<b>Multi-Lok</b>													
<b>Coated      Uncoated</b>													
AE6119	AE6019	316 SS	0.276	7.01	6.0	150	0.018 / 0.011	0.46 / 0.28	1.3	33	250	100/Bag	M50389 XE9229
AE6129	AE6029	316 SS	0.276	7.01	9.0	225	0.018 / 0.011	0.46 / 0.28	2.2	57	250	100/Bag	
AE6139	AE6039	316 SS	0.276	7.01	12.0	300	0.018 / 0.011	0.46 / 0.28	3.2	81	250	100/Bag	
AE6149	AE6049	316 SS	0.276	7.01	18.0	450	0.018 / 0.011	0.46 / 0.28	5.1	129	250	100/Bag	
AE6159	AE6059	316 SS	0.276	7.01	24.0	610	0.018 / 0.011	0.46 / 0.28	7.1	180	250	100/Bag	
AE7119*	AE7019*	316 SS	0.472	12.0	6.0	150	0.018 / 0.011	0.46 / 0.28	1.3	33	415	100/Bag	
AE7129*	AE7029	316 SS	0.472	12.0	9.0	225	0.018 / 0.011	0.46 / 0.28	2.2	57	415	100/Bag	
AE7139*	AE7039	316 SS	0.472	12.0	12.0	300	0.018 / 0.011	0.46 / 0.28	3.2	81	415	100/Bag	
AE7149*	AE7049	316 SS	0.472	12.0	18.0	450	0.018 / 0.011	0.46 / 0.28	5.1	129	415	100/Bag	
AE7159*	AE7059	316 SS	0.472	12.0	24.0	610	0.018 / 0.011	0.46 / 0.28	7.1	180	415	100/Bag	

\* Subject to extended lead time and minimum order quantities. Call for quotes.



DNV-GL



## Ultra-Lok® Ties

- Strongest Tie
- Smooth ID ties with low profile
- Stainless Steel tie with ULTRA-LOK® locking style
- Provides fast, reliable, consistent clamp
- Great for cable bundling

Part No.	Material	Width		Length		Thickness		Maximum Diameter Single Wrap		Minimum Loop Tensile Strength (Lbs)	Package Quantity	Application Tools
		In	mm	In	mm	In	mm	In	mm			
<b>ULTRA-LOK® Ties</b>												
AU2029	201 SS	0.25	6.4	8	203	0.015	0.38	1.5	38	400	100/Bag	A94079
AU2039	201 SS	0.25	6.4	10	254	0.015	0.38	2.5	63	400	100/Bag	
AU2089	201 SS	0.25	6.4	24	610	0.015	0.38	7	177	400	100/Bag	

# BALL-LOK TIES

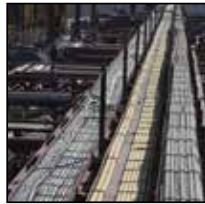

**Ball-Lok Ties are quick and easy to apply offering a versatile solution for heavy duty applications.**

Ball-Lok Ties come with a heavy duty buckle that offers superior corrosive, abrasive and UV resistance performance that makes this product perfect for harsh duty or marine environments.

- Two widths - 0.18" (4.6mm) and 0.31" (7.9mm)
- Self locking design allows fast installation
- Install with tools to ensure uniform tension and clean tail cut-off for safe handling
- Available in Type 304 and Type 316 stainless steels to provide good to excellent corrosion resistance in a wide variety of environments
- Fully coated with black, halogen free epoxy
- This product line is also available with halogen free, low smoke black selectively coated Nylon 11 coating which reduces the risk of cutting or abrading cable insulation or hose coverings

Part Number	Width		Length		Base Material Thickness		Maximum Bundle Diameter		Minimum Loop Tensile Strength (Lbs)	Package Quantity	Application Tools
	In	mm	In	mm	In	mm	In	mm			
<b>Ball-Lok Ties</b>											
<b>304 SS Uncoated Material</b>	<b>316 SS Uncoated Material</b>	<b>*90 day lead time, expedited shipping available (US only)</b>									
KE1118*	KE0118	0.18	4.6	5.9	150	0.010	0.25	1.2	30	200	100/Bag
KE1128	KE0128	0.18	4.6	7.9	201	0.010	0.25	2.0	50	200	100/Bag
KE1138	KE0138	0.18	4.6	10.2	259	0.010	0.25	2.7	69	200	100/Bag
KE1148	KE0148	0.18	4.6	14.2	360	0.010	0.25	4.0	102	200	100/Bag
KE1158*	KE0158	0.18	4.6	20.4	520	0.010	0.25	6.0	152	200	100/Bag
KE1168*	KE0168	0.18	4.6	26.8	679	0.010	0.25	8.0	203	200	100/Bag
KE1178*	KE0178*	0.18	4.6	33.0	838	0.010	0.25	10.0	254	200	100/Bag
KE1188*	KE0188	0.18	4.6	42.0	1067	0.010	0.25	12.0	305	200	100/Bag
KE1328	KE0328	0.31	7.9	7.9	201	0.010	0.25	2.0	50	300	100/Bag
KE1338*	KE0338	0.31	7.9	10.2	259	0.010	0.25	2.7	69	300	100/Bag
KE1348	KE0348	0.31	7.9	14.2	360	0.010	0.25	4.0	102	300	100/Bag
KE1358	KE0358	0.31	7.9	20.4	520	0.010	0.25	6.0	152	300	100/Bag
KE1368	KE0368*	0.31	7.9	26.8	679	0.010	0.25	8.0	203	300	100/Bag
KE1378*	KE0378*	0.31	7.9	33.0	838	0.010	0.25	10.0	254	300	100/Bag
KE1388*	KE0388	0.31	7.9	42.0	1067	0.010	0.25	12.0	305	300	100/Bag
<b>* Subject to extended lead time and minimum order quantities. Call for quotes.</b>											
<b>316 SS Coated Material (Epoxy)</b>											
KE0228*		0.18	4.6	7.9	201	0.010	0.25	2.0	50	150	100/Bag
KE0238*		0.18	4.6	10.2	259	0.010	0.25	2.7	69	150	100/Bag
KE0248*		0.18	4.6	14.2	360	0.010	0.25	4.0	102	150	100/Bag
KE0258*		0.18	4.6	20.4	520	0.010	0.25	6.0	152	150	100/Bag
KE0268*		0.18	4.6	26.8	679	0.010	0.25	8.0	203	150	100/Bag
KE0278*		0.18	4.6	33.0	838	0.010	0.25	10.0	254	150	100/Bag
KE0428*		0.31	7.9	7.9	201	0.010	0.25	2.0	50	175	100/Bag
KE0438*		0.31	7.9	10.2	259	0.010	0.25	2.7	69	175	100/Bag
KE0448*		0.31	7.9	14.2	360	0.010	0.25	4.0	102	175	100/Bag
KE0458*		0.31	7.9	20.4	520	0.010	0.25	6.0	152	175	100/Bag
KE0468*		0.31	7.9	26.8	679	0.010	0.25	8.0	203	175	100/Bag
KE0478*		0.31	7.9	33.0	838	0.010	0.25	10.0	254	175	100/Bag
<b>* Subject to extended lead time and minimum order quantities. Call for quotes.</b>											



K50289  
XE9229  
or by hand

# BALL-LOKT™ TIES

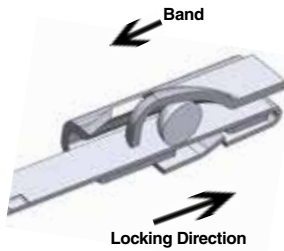

**Ball-Lokt™ Ties unique buckle design is the globally accepted industry standard.**

- Four widths – 0.18" (4.6mm), 0.31" (7.9mm), 0.47" (12mm), and 0.59" (15mm) for applications ranging from identification tagging to bundling large cables
- Self locking design allows fast installation
- Installation with hand tool to assure uniform tension and clean tail cut-off for safe handling
- Available in Type 304 and Type 316 stainless steels to provide good to excellent corrosion resistance in a wide variety of environments
- Coated Ball-Lokt™ Ties are fully coated with black epoxy

Part Number	Material	Width		Length		Base Material Thickness		Maximum Diameter Single Wrap		Minimum Loop Tensile Strength lbs	Package Quantity	Application Tools
		In	mm	In	mm	In	mm	In	mm			
<b>Ball-Lok™ Ties</b>												
<b>Coated</b>	<b>Uncoated</b>											
	KT4U046-0200*	304 SS	0.18	4.6	7.9	200	0.010	0.25	2.0	52	100	100
	KT4U046-0250*	304 SS	0.18	4.6	9.8	250	0.010	0.25	2.7	67	100	100
	KT4U046-0350*	304 SS	0.18	4.6	13.8	350	0.010	0.25	3.9	99	100	100
	KT4U046-0500*	304 SS	0.18	4.6	19.7	500	0.010	0.25	5.8	147	100	100
KT6B046-0200*	KT6U046-0200*	316 SS	0.18	4.6	7.9	200	0.010	0.25	2.0	52	100	100
KT6B046-0250*	KT6U046-0250	316 SS	0.18	4.6	9.8	250	0.010	0.25	2.7	37	100	100
KT6B046-0350	KT6U046-0350	316 SS	0.18	4.6	13.8	350	0.010	0.25	3.9	99	100	100
KT6B046-0500*	KT6U046-0500*	316 SS	0.18	4.6	19.7	500	0.010	0.25	5.8	147	100	100
	KT4U078-0200*	304 SS	0.31	7.9	7.9	200	0.010	0.25	2.0	52	175	100
	KT4U078-0250	304 SS	0.31	7.9	9.8	250	0.010	0.25	2.7	67	175	100
	KT4U078-0350	304 SS	0.31	7.9	13.8	350	0.010	0.25	3.9	99	175	100
	KT4U078-0500*	304 SS	0.31	7.9	19.7	500	0.010	0.25	5.8	147	175	100
	KT4U078-0600*	304 SS	0.31	7.9	23.6	600	0.010	0.25	7.0	179	175	100
KT6B078-0200*	KT6U078-0200*	316 SS	0.31	7.9	7.9	200	0.010	0.25	2.0	52	175	100
KT6B078-0250*	KT6U078-0250*	316 SS	0.31	7.9	9.8	250	0.010	0.25	2.7	67	175	100
KT6B078-0350	KT6U078-0350*	316 SS	0.31	7.9	13.8	350	0.010	0.25	3.9	99	175	100
KT6B078-0500*	KT6U078-0500	316 SS	0.31	7.9	19.7	500	0.010	0.25	5.8	147	175	100
KT6B078-0600*	KT6U078-0600*	316 SS	0.31	7.9	23.6	600	0.010	0.25	7.0	179	175	100
KT6B120-0450*	KT6U120-0450*	316 SS	0.47	12	17.7	450	0.014	0.35	5.2	131	250	100
KT6B120-0550*	KT6U120-0550*	316 SS	0.47	12	21.7	500	0.014	0.35	6.4	163	250	100
KT6B120-0600*	KT6U120-0600*	316 SS	0.47	12	23.6	600	0.014	0.35	7.0	179	250	100
KT6B150-0500	KT6U150-0500*	316 SS	0.59	15	19.7	500	0.014	0.35	5.8	147	325	50
KT6B150-0600*	KT6U150-0600	316 SS	0.59	15	23.6	600	0.014	0.35	7.0	179	325	50
KT6B150-0700*	KT6U150-0700*	316 SS	0.59	15	27.6	700	0.014	0.35	8.3	211	325	50
KT6B150-0750	KT6U150-0750	316 SS	0.59	15	29.5	750	0.014	0.35	9.6	243	325	50
KT6B150-0900*	KT6U150-0900*	316 SS	0.59	15	35.4	900	0.014	0.35	10.8	274	325	50
KT6B150-1100*	KT6U150-1100*	316 SS	0.59	15	43.3	1100	0.014	0.35	13.3	338.2	325	50

\* Subject to extended lead time and minimum order quantities. Call for quotes.



K50289  
XE9229  
or by hand

# BAND-IT® Reusable AE Ties



- Constructed of 316 Stainless Steel with PPA 571 coating
- PPA 571 is resistant to stress cracking, adverse weather conditions, detergents, salt spray and typical airborne pollutants
- One-piece construction with unique buckle designs capable of double wrapping for special strength requirements and reliable installation



DNV-GL

Coated Part No	Material***	Width		Length		Thickness Coated		Maximum Diameter Single Wrap		Minimum Loop Tensile Strength (Lbs)	Package Quantity	Application Tools
		In	mm	In	mm	In	mm	In	mm			
<b>BAND-IT AE Ties</b>												
AE1118	316 SS	1/4	6.4	6	152	0.045	1.1	1.5	38	75/300**	100/Bag	AE2009 C07569 or by hand
AE1128	316 SS	1/4	6.4	9	229	0.045	1.1	2.5	63	75/300**	100/Bag	
AE1138	316 SS	1/4	6.4	12	305	0.045	1.1	3.4	86	75/300**	100/Bag	
AE1148	316 SS	1/4	6.4	18	457	0.045	1.1	5.4	137	75/300**	100/Bag	
AE1158	316 SS	1/4	6.4	24	610	0.045	1.1	7.3	185	75/300**	100/Bag	
AE3138	316 SS	3/8	9.6	12	305	0.045	1.1	3.4	86	100/500**	100/Bag	
AE3148	316 SS	3/8	9.6	18	457	0.045	1.1	5.4	137	100/500**	100/Bag	
AE3158*	316 SS	3/8	9.6	24	610	0.045	1.1	7.3	185	100/500**	100/Bag	
AE3178*	316 SS	3/8	9.6	36	914	0.045	1.1	11	280	100/500**	100/Bag	

\* Subject to extended lead time and minimum order quantities. Call for quotes.  
 \*\* Single / Double Wrapped  
 \*\*\* Material thickness includes coating

AE Ties





# Stainless Steel Cable Ties



	TIE-LOK		BALL-LOK UCTD		BALL-LOK CTD		MULTI-LOK UCTD		MULTI-LOK CTD		BAND-IT TIE CTD		BAND-FAST CLAMP	
	.177 .25 In	4.5 6.35 mm	.18 .03 In	4.6 7.9 mm	.18 .03 In	4.6 7.9 mm	.27 .47 In	7 12 mm	.27 .47 In	7 12 mm	.25 .375 In	6.35 9.53 mm	.375 .5 In	9.53 12.7 mm
<b>AVAILABLE WIDTHS</b>														
<b>Quick Reference of Product Features</b>														
304 S/S (for general corrosion resistance)	●	●	●	●										
316 S/S (for general corrosion resistance)	●	●	●	●	●	●	●	●	●	●	●	●	●	●
Uncoated	●	●	●	●			●	●					●	●
Epoxy Coated					●	●								
Nylon 11 Coated									●	●				
PPA 571											●	●	●	●
Black Color					●	●			●	●	●	●	●	●
Self Locking			●	●	●	●	●	●	●	●				
Releasable / Reusable											●	●		

# Identification Systems

Print your own tags on 304 or 316 stainless steel and apply with Tie-Lok® Ties. ID tag imprinter is available with a choice of character sizes. Imprinter with character wheel weighs 29.5 lbs (13.4kg).

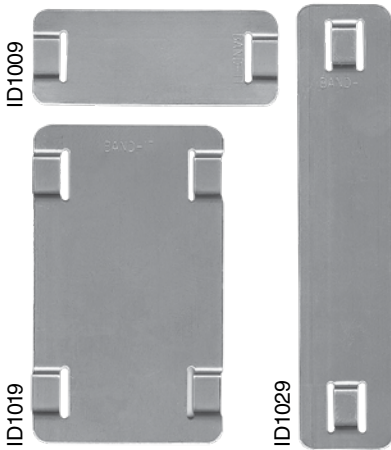

## Tags

Part No.	Material	Height		Length		Thickness		Package Weight		Package Quantity
		in	mm	in	mm	in	mm	Lbs	Kg	
<b>ID Tags</b>										
ID1009	304 SS	.75	19	2.0	50.8	.015	.38	.5	.2	100/Box
ID1019	304 SS	1.5	38.1	2.5	63.5	.015	.38	1.2	.6	100/Box
ID1029	304 SS	.75	19	3.5	88.9	.015	.38	.8	.4	100/Box
ID4409	316 SS	.75	19	2.0	50.8	.015	.38	.5	.2	100/Box
ID4419	316 SS	1.5	38.1	2.5	63.5	.015	.38	.8	.4	100/Box
ID4429	316 SS	.75	19	3.5	88.9	.015	.38	1.2	.6	100/Box



ID Tag Imprinter Tool

## Stainless Steel Tagging System

### ID Tag Imprinter Tool

Part No.	Tool supplied with:
ID2006	3/32" character wheel



ID3009 ID Kit

## Identification Kit

The BAND-IT ID Kit comes with an assortment of blank ID tags to use with the ID Tagging Systems. Includes various Tie-Lok Ties and Tie-Lok tool to fasten tags to items. Total weight is 22.7 lbs, 10.3 Kg. Kit Contains: 1-A92079, 2-ID1029, 1-ID1019, 1-ID1009, 1-AS2119, 2-AS2129, 1-AS2139

## Stainless Steel Tape Embossing System

With the portable tape embossing tool and a roll of 304 stainless steel tape, you can quickly and easily produce I.D. tags with 3/16" letter size which can be attached with your choice of 1/4" BAND-IT® ties.

Replacement Rolls: ID4059 - 1/2" X 21' - 2 pack.



ID4002 SS Embossing System

Part No.	Description	Package Weight		Package Quantity
		Lbs	Kg	
<b>Embossing System</b>				
ID4002	SS Tape Embossing Tool Includes 2 rolls of SS tape.	2.6	1.2	each
ID4059	304 SS Tape Roll for Embossing Tool, 1/2" x 21' x .005"	0.2	0.4	each

# Easy Read Identification



**AE0609-100  
Easy Read Kit**

The kit comes in a convenient carrying case weighing 19.5 lbs and contains 100 of each character and carriers.

## Easy Read on Carriers



## Easy Read on Ties



EASY READ characters slide onto any 1/4" - 3/8" tie.

- BAND-IT EASY READ letters, numbers and are symbols made from type 316 SS
- Slide directly onto Easy Carriers or cable ties to create a self-contained wrap tag
- Easy to read in dim light and inaccessible places
- Characters sold individually in bags of 100 pcs

## Easy Read Characters

Part No.	Description	Package Weight		Package Quantity
		Lbs	Kg	
<b>Easy Read Characters</b>				
AE0109	EASY A	0.3	0.2	100/Bag
AE0119	EASY B	0.3	0.2	100/Bag
AE0129	EASY C	0.3	0.2	100/Bag
AE0139	EASY D	0.3	0.2	100/Bag
AE0149	EASY E	0.3	0.2	100/Bag
AE0159	EASY F	0.3	0.2	100/Bag
AE0169	EASY G	0.3	0.2	100/Bag
AE0179	EASY H	0.3	0.2	100/Bag
AE0189	EASY I, 1	0.3	0.2	100/Bag
AE0199	EASY J	0.3	0.2	100/Bag
AE0209	EASY K	0.3	0.2	100/Bag
AE0219	EASY L, 7	0.3	0.2	100/Bag
AE0229	EASY M, W	0.3	0.2	100/Bag
AE0239	EASY N	0.3	0.2	100/Bag
AE0249	EASY O	0.3	0.2	100/Bag
AE0259	EASY P	0.3	0.2	100/Bag
AE0269	EASY Q	0.3	0.2	100/Bag
AE0279	EASY R	0.3	0.2	100/Bag
AE0289	EASY S	0.3	0.2	100/Bag
AE0299	EASY T	0.3	0.2	100/Bag
AE0309	EASY U	0.3	0.2	100/Bag
AE0319	EASY V	0.3	0.2	100/Bag
AE0329	EASY X	0.3	0.2	100/Bag
AE0339	EASY Y	0.3	0.2	100/Bag
AE0349	EASY Z	0.3	0.2	100/Bag
AE0379	EASY 2	0.3	0.2	100/Bag
AE0389	EASY 3	0.3	0.2	100/Bag
AE0399	EASY 4	0.3	0.2	100/Bag
AE0409	EASY 5	0.3	0.2	100/Bag
AE0419	EASY 6, 9	0.3	0.2	100/Bag
AE0429	EASY 8	0.3	0.2	100/Bag
AE0359	EASY Minus/Hyphen	0.3	0.2	100/Bag
AE0369	EASY Blank	0.3	0.2	100/Bag
AE0469	EASY Plus +	0.3	0.2	100/Bag
AE0479	EASY Earth	0.3	0.2	100/Bag
AE0489	EASY Sine ~	0.3	0.2	100/Bag
AE0499	EASY Slash /	0.3	0.2	100/Bag



## Apply EASY READ Characters with these 1/4" - 3/8" products:

- Carriers
- Coated BAND-IT® Ties
- Coated Ball-Lok Ties
- Coated Ball-Lokt™ Ties
- Coated Multi-Lok Ties

## Easy Carriers

Part No.	Description	Width		Length		Package Weight		Package Quantity
		in	mm	in	mm	Lbs	Kg	
<b>Easy Carriers</b>								
AE0449	EASY Carrier 10	0.3	10	5.1	131	1.3	0.6	100/Bag
AE0459	EASY Carrier 16	0.3	10	7.3	188	1.5	0.7	

*Easy Carriers are available in black Nylon 11 coated Stainless Steel only.*

# Mounting Hardware

Engineered to achieve a strong and secure grip on all components, provides superior corrosion resistance, and will sustain the hold in high vibration environments while keeping the support system compact.

- Specially designed reinforced SIGNFIX® Channel extrusions
- Convenient attachment methods
- Hex head bolts with metal and fiber washer, no nuts required
- Applied with BAND-IT® banding products
- Banding size may vary depending on application. Please contact your BAND-IT® representative for further details

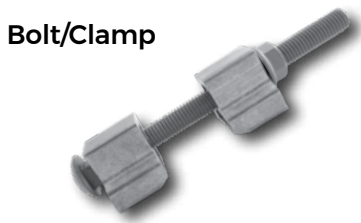

Bolt/Clamp



Mounting Bracket

Mount Plate



Mount Plate - Narrow Back



Part No.	Material	Description	Package Quantity	Package Weight	
				Lbs	Kg
<b>Bolt / Clamp</b>					
D50089	Aluminum*	Bolt/clamp. Use with maximum 3/4" width band.	50/Box	23.7	10.8
D50489	Aluminum*	Bolt/clamp. Use with maximum 1-1/4" width band.	25/Box	33.0	15.0
<b>Mounting Bracket</b>					
D51089	Aluminum	1-1/2" (38.1 mm) x 4-3/4" (120.7 mm) with a 2" long 5/8" plated bolt.	25/Box	14.9	6.8
D51289	Aluminum	1-1/2" (38.1 mm) x 5-1/4" (133.3 mm) with a 2" long 5/8" plated bolt.	25/Box	21.0	9.5
D51389	Aluminum	1-1/2" (38.1 mm) x 5-1/4" (133.3 mm) with a 3" long 5/8" plated bolt.	25/Box	21.0	9.5
<b>Mount Plate</b>					
D04099	Aluminum	Mount Plate, 1-1/2" NPT	25/Box	19.4	8.8

\*Bolt is a plated carriage bolt

**Mounting Bracket Slots:** accepts a double wrap of .044" x 1-1/4" BAND-IT Band.

## Mounting Brackets

Used to mount traffic signs, security devices, and enclosures. Designed to withstand wind vibration with reinforced ribs, and applied with BAND-IT® Band and Buckles, VALU-STRAP™, VALU-STRAP PLUSTM, BANDFAST®, or the ULTRA-LOK® Systems.

Part No.	Material	Description	Package Quantity	Package Weight	
				Lbs	Kg
<b>Mounting Brackets</b>					
D00189	200/300SS	Single bolt straight leg, bracket with 304SS bolt, washer and fiber washer. 3/4" slot.	50/Box	7.0	3.2
D00299	200/300SS	5/6"-18x3/4" hex head SS Bolt, SS washer and fiber washer.	50/Box	1.3	0.6
D00499	200/300SS	Single bolt straight leg, bracket only. 3/4" slot.	50/Box	5.6	2.6
D00799	200/300SS	L-Mount, right angle bracket	50/Box	4.4	2.0
D00889	200/300SS	2 bolt straight leg, bracket with SS washer and fiber washer. 3/4" slot.	50/Box	9.2	4.2
D00999	200/300SS	2 bolt straight leg, bracket only 3/4" slot.	50/Box	7.1	3.2
D02189	200/300SS	Single bolt flared leg, bracket with SS bolt, SS washer and fiber washer. 3/4" slot.	50/Box	7.0	3.2
D02299	200/300SS	Single bolt flared leg, bracket only. 3/4" slot.	50/Box	5.5	2.5
D30288	200/300SS	5/16"-24 x 1/2" Hex Head SS bolt, washer and fiber washer.	50/Box	1.0	0.5
D31099	200/300SS	Flared leg mini-bracket with 304SS bolt and fiber washer. 1/2" slot.	50/Box	3.0	1.3
D31599	200/300SS	Straight leg mini-bracket with 304SS bolt and fiber washer. 1/2" slot.	50/Box	3.0	1.3



**D31099 Flared Leg Mini-Brack-It**

**D31599 Straight Leg Mini-Brack-It**

**D02189 Single Bolt Flared Leg**

**D00189 Single Bolt Straight Leg**

**D00889 2 Bolt Straight Leg**

**D00799 L-Mount Right Angle Brack-It**

# SIGNFIX®

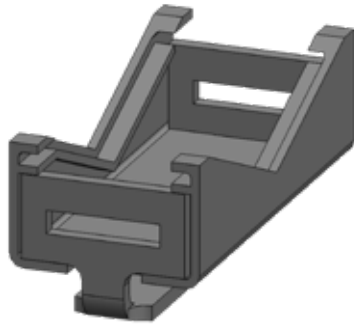

## SX0220-100

Universal Channel Clamp

## SIGNFIX® Modular Sign Support Systems

SIGNFIX® is recognized by sign fabricators as a quicker, easier and cost effective method to mount all sizes of signs to any size or shape of pole.

### Universal Channel Clamp

- Compatible with all SIGNFIX® Channel Extrusions
- During installation, the assembly becomes fully adjustable to any size or style sign post when used with BAND-IT® Band and Buckle or Ultra-Lok® Free End System
- Package Quantity 100
- Accepts up to 3/4" band double wrapped

## Support Channel Extrusions

For mounting and stiffening any size sign. SIGNFIX® Channel Extrusions have identical configurations allowing the use of all SIGNFIX® hardware with any extrusion.

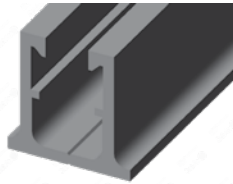

**SX0073-20 Medium**  
Channel Extrusion

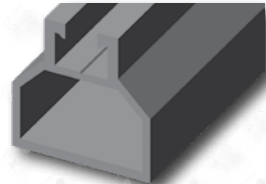

**SX0130-6 Large**  
Channel Extrusion

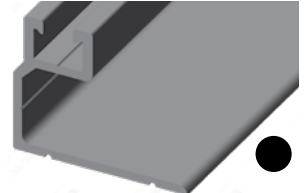

**SX0090-8 Large Corner Angle**  
Channel Extrusion

# Adjustable Clamping Systems



Scru-Band Rack and Housing

## Scru-Band Clamping Systems

BAND-IT Scru-Seal Kit uses a rack and pinion system allowing the user to make a clamp in any size. Kit offers complete flexibility for use in almost any application. Form clamps of any diameter from continuous roll of band and tension using only a screwdriver.

Part No.	Material	Description	Package Weight		Package Quantity	Application Tools
			lbs	Kg		
<b>Scru-Band Clamping System</b>						
M15199	SS	Scru-Band, 430SS 3/8" x .025" x 100'	3.4	1.6	100'/roll	
M15599	SS	Scru-Band Housing and Screw	0.53	0.24	25/box	

Designed for light duty applications.

## Scru-Seal Clamping Systems

A rack and pinion system used with band to create any size clamp. Components separately packaged for flexibility.

Part No.	Material	Description	Package Weight		Package Quantity	Application Tools
			lbs	Kg		
<b>Scru-Seal Clamping System</b>						
M21199	SS	10 Scru-Seal racks and 10 Housings	0.7	0.3	10/box	Flat Head Screwdriver
C13399	SS	VALU-STRAP™ Band, 3/8" x 0.015" x 100'	2.2	1.0	100'/roll	
C13499	SS	VALU-STRAP™ Band, 1/2" x 0.015" x 100'	2.9	1.3	100'/roll	5/16" Nut Driver
M21199-25	SS	25 Scru-Seal racks and 25 Housings	1.7	0.7	25/box	
M21199-100	SS	100 Scru-Seal racks and 100 Housings	7.0	3.1	100/box	
<b>Kits - Everything you need in a single package</b>						
M21099	SS	Scru-Seal Kit includes: 25 Scru-Seal racks, 25 housings, VALU-STRAP™ Band 3/8" x 0.015" x 100'	4.3	1.9	each	Flat Head Screwdriver
M21899	SS	Each Clamp Pak includes: 3 Scru-Seal racks, 3 housings, VALU-STRAP™ Band 3/8" x 0.015" x 10'	5.0	2.3	10 paks/box	5/16" Nut Driver



Scru-Seal Kit with VALU-STRAP™ M21099



Clamp-Pak M21899

Designed for light duty applications.

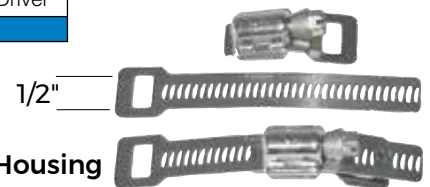

Scru-Seal Rack & Housing

## HAND TOOLS

### C00169 Standard Banding Tool



#### Use with

- Band & Buckle
- BAND-FAST®

Junior Adapters Below

### J05069 Junior® Heavy Duty Adapter



#### Use with

- BAND-IT® Tool on the BAND-IT® Junior® Smooth ID Preformed Clamps

### J00169 Junior® Clamp Adapter



#### Use with

- BAND-IT® Tool on the BAND-IT® Junior® Smooth ID Preformed Clamps

### C00269 Junior® Preformed Clamp Tool



#### Use with

- BAND-IT® Junior® Smooth ID Preformed Clamps

### C00369 Heavy Duty Banding Tool



#### Use with

- BAND-FAST® & Roll Band

BAND-IT's standard tool for use on band widths of 1/4" to 3/4" (.015" - .030" thickness).

Replacement Parts:

- C02499 - Kit, Gripper, Gripper Spring, Groove Lock Pin, Slide Block, and Tension Screw
- C05887 - Kit, Cutter Bar Assembly
- C00689 - Kit, Tension Handle, Bearing and Screw

Used only with the C00169 BAND-IT® Tool to install Junior® Smooth I.D. Preformed Clamps for hose assembly when a vise is not available.

Replacement Parts:

- J00587 - Shear Hook
- J93099 - Junior® Lock Universal Cutter Blade Kit

Replacement Parts:

- J00587 - Shear Hook
- J93099 - Junior® Lock Universal Cutter Blade Kit

Use to apply Junior® Preformed clamps and BAND-IT® Junior® Smooth ID Clamps. Tool performs best when used in a vice on band widths over 1/2".

Replacement Parts:

- C00689 - Tension Handle and Screw Kit
- C01899 - Gripper Assembly Kit
- J01499 - Handle Assembly Jr. Adapter
- J93099 - Cutter Blade Kit

The C00369 is a heavy duty version of the C00169 tool. Primarily designed for thicker materials and is not recommended for band thickness 0.015" or 0.020". This tool can be used for 0.044" X 3/4" wide Giant Band. Tool will tension beyond the limits of the 3300 lbs of force to yield 3/4" wide 201SS Giant Band.

Replacement Parts:

- C04799 - Spin Grip, External Retaining Ring, Tension Handle Bushing, Tension Handle, Set Screw, and Thrust Bearing
- C06799 - Tension Screw 5/8", Eccentric Lever Pivot Pin, Gripper Spring, Band Gripper, and Slide Block
- C05887 - Cutter Bar Handle, Vinyl Grip, Set Screw, and Cutter Bar



## HAND TOOLS

### G40269 Giant Banding Tool



#### Use with

- BAND-FAST® & Roll Band

The G40269 is the strongest BAND-IT hand tool. This tool is designed for use with ¾", 1", 1-¼" width X .044" thick Giant Band & Buckle. Tool will tension beyond the limits of the 5500 lbs of force to yield 201 Stainless Steel Giant Band material.

Replacement Parts:

- G42487 - Slide Block Assembly
- G42087 - Tension Handle Assembly
- G42287 - Cutter Bar Assembly

### T30069 Center Punch Tool



Used to apply BAND-IT® 3/8" and 5/8" Center Punch Clamps, 201 Stainless Steel Band and Galvanized Carbon Steel Clamps.

Replacement Parts:

- T28088 - Head Assembly
- T28888 - Nose and Slide Assembly
- T32190 - Punch Kit
- T32290 - Gripper Kit

### S03869 Center Punch Tool



Easy to use ratchet drive can be switched to use either the 3/8" wide or 5/8" wide slots of this pocket style tool.

### C08569 Bantam Strapping Tool



The C08569 Bantam Strapping Tool is a light duty ratchet tool designed for palletizing and packaging. Similar to the C07569.

For use on max 0.025" (0.63mm) steel thickness.

### C40099 Ratchet Tool



The C40099 Ratchet Tool is a ratchet tool designed for the band and buckle systems excelling in palletizing and general banding. This tool works best on coated or painted band because of its gripping mechanism.

### J02069 Pok-It II Tool with Cutter



The J02069 Pok-It II Tool with Cutter has a compact design and ease of use to install 3/16" - 3/8" band and buckle and BAND-IT Jr. clamps. The ratchet design enables a quick strong tensioning for narrow band clamps.

## HAND TOOLS

### XE9229 Tensioning Tool

#### Use with

- *Ball-Lok Ties*
- *Ball-Lokt™ Ties*
- *Multi-Lok Ties*

KE9229 outside the US



Tensions and cuts off Ball-Lok, Ball-Lokt™ and Multi-Lok ties up to 12mm wide regardless of material or coating.

### C07569 Bantam Tool

#### Use with

- *BAND-IT Ties*
- *PPA Coated Band*
- *Valustrap*
- *PPA Coated BAND-FAST®*



BAND-IT® Bantam tool is a compact, lightweight, ratchet action tool with built in cutter.

- 3 way handle adjusts for one or two-handed tensioning
- Zinc plated for corrosion resistance
- Useful in tight areas with minimal access
- Designed for easy loading and removing of material
- Use with coated and uncoated BAND-IT® ties or Coated Band up to 19mm wide and up to 0.025" (0.63mm) steel thickness.

### K50289 Ball-Lok Tool

#### Use with

- *Ball-Lok Ties*
- *Ball-Lokt™ Ties*



Install Ball-Lok and Ball-Lokt™ stainless steel ties (up to 7.9mm wide) quickly and easily with the lightweight, portable Ball-Lok tool with adjustable tension, side loading and automatic tail cut-off.

### M50389 Multi-Lok Hand Tool

#### Use with

- *Multi-Lok Ties*



Quickly, easily and consistently applies any size Multi-Lok ties. Simply adjust the Multi-Lok tool for the desired tension, slip the Multi-Lok in the slot, or side load, and squeeze the handle. When the proper tension is reached, the Multi-Lok tool automatically cuts the tail off flush with the buckle.

## HAND TOOLS

### A91079 Mini Tie-Lok II Tool

#### Use with

- 0.177" wide (4.5mm) Mini Tie-Lok® Ties



For applying 0.177" wide smooth ID Mini Tie-Lok® ties for cable bundling, hose bundling and identification tagging. Forms unique dimple lock with a strong locking force and cuts off the excess band flush with top of buckle so the completed lock is smooth and not sharp.

- Forms dimple lock with a strong locking force in excess of 100 pounds (45 Kg)
- Adjustable controlled tension with repeatable results
- Easy to use, lightweight, compact design

### A92079 Tie-Lok® II Tool

#### Use with

- 1/4" wide (6.35mm) Tie-Lok® Ties



Applies 1/4" wide smooth ID Tie-Lok® ties used in cable bundling, hose bundling, CV boot installation and identification tagging. Locks tie with the patented Tie-Lok® and cuts off excess band flush with top of buckle so the completed lock is smooth and not sharp.

- Forms dimple lock with a strong locking force in excess of 250 pounds (130 Kg)
- Adjustable controlled tension with repeatable results
- Easy to use, lightweight, compact design

### TL3800 Tie-Lok® Tool

#### Use with

- Tie-Lok® Stainless Steel Ties in 3/8" width (9.53mm) only



The TL3800 Tie-Lok® tool is specifically designed to install 3/8" wide Tie-Lok® stainless steel ties. Repeatable, controlled tie tension. Punch depth limiter. Lightweight, compact design. Cut off produces clean hidden edges.

### A94079 ULTRA-LOK® Tool

#### Use with

- Ultra-Lok® Ties



Applies Smooth ID ULTRA-LOK® ties. Locks tie with patented ULTRA-LOK® cut-off for increased loop tensile strength.

- Tool will tension clamp up to 400lbs of loop tensile strength

### AE2009 Tool



The AE2009 hand tool is used for tensioning BAND-IT® cable ties.  
Use with: BAND-IT Ties

## POWER TOOLS

### UL4000-D ULTRA-LOK® Cordless Tool



#### Use with

- Ultra-Lok® Band & Preformed Clamps

### IT Series Tool



#### Use with

- BAND-IT® Tie-Lok® Ties, and Junior® Smooth ID Preformed Clamps

Ideal for mobile installations. Now powered with a Lithium-ion battery, with longer charge and battery life, the UL4000-D battery charge lasts longer with consistent peak performance through the life of the battery.

#### Replacement Parts:

- M09387 - Shear Plate for Installing 1/2" Wide UL Clamps
- M09887 - Shear Plate for Installing 3/4" Wide UL Clamps
- M09787 - Cutter Blade for Installing All UL Clamps
- C23187 - Lubricant for Tension Threads
- UL1219 - Handle Kit

The IT Series Tool (with air hose and regulator) is a hand held tool used for repeatable high production environments.

- Can be fixtured into production system
- Variety of head configurations that allow installation of
  - .177", 1/4" and 3/8" Tie-Lok®
  - 1/4" Universal Clamps
  - 1/4" and 3/8" Jr.® Smooth ID Clamps
- Ergonomic design for ease of use by hand
- Heavy-duty cut-off and tensioning components
- Durable pneumatic system
- Easy to maintain

#### Available Versions.

- IT0750 For all .177" Mini Tie-Lok® Ties
- IT1000 For all 1/4" Tie-Lok® Ties and 1/4" Universal Clamps
- IT2000 For all 1/4" BAND-IT Junior® Clamps
- IT5000 For all 3/8" BAND-IT Junior® Clamps
- IT6000 For all 3/8" Tie-Lok® Ties

## POWER TOOLS

### S75099 Pneumatic Junior® Clamp Application Tool



#### Use with

- *BAND-IT® Junior® Smooth ID Preformed Clamps*

### S35099 Pneumatic Junior® Clamp Automatic Air Tool



#### Use with

- *BAND-IT® Junior® Smooth ID Preformed Clamps*

### SM1700 Pneumatic Automatic Center Punch Clamp Air Tool



#### Use with

- *BAND-IT® Center Punch Preformed Clamps*

The "Standard Air Tool". The foot controlled standard air tool applies the complete range of BAND-IT Junior® and Junior® Smooth ID preformed clamps.

#### Replacement Parts:

- S45799 - Band Gripper Kit
- J93099 - Junior Lock Universal Cutter Blade Kit
- J00587 - Shear Hook
- S45087 - Tripper Plate

For high volume production clamping of all widths and diameter sizes of BAND-IT Junior® Smooth ID and Junior® preformed clamps. Automatically tensions and cuts off clamp tail after roll-up and lock.

#### Replacement Parts:

- S45799 - Band Gripper Kit
- J93099 - Junior Lock Universal Cutter Blade Kit
- S45087 - Tripper Plate

Designed to install BAND-IT® Center Punch 5/8" wide preformed clamps, made from 201 Stainless Steel and Galvanized Carbon Steel. Automatically tensions and cuts off clamp tail.

#### Replacement Parts:

- S45199 - CP Band Gripper Kit
- M17799 - CP Cutter Blade Kit
- S45087 - Tripper Plate

## Electrical Applications



**Oil Rigs, Ships, Chemical Plants, Refineries, Industrial Complexes, Public Buildings, Mining, Bridges and Tunnels, Power Distribution, Transmission and Communications**

### Engineered Fastening and Bundling Systems for Extreme Conditions:

Electrical cable management, heat and sound shield fastening, instrument tubing and device attachment.

**Products:** Ball-Lok™, Ball-Lok, Multi-Lok, Tie-Lok®, BAND-IT® Tie, BAND-FAST®, Uncoated and Coated Band & Clip\*\*.

### Benefits:

- Superior performance in extreme temperatures, chemical exposure, salt spray conditions and UV light exposure
- Permanent and secure locking mechanisms
- Reliable and efficient installation tools
- Low installed cost and long service life
- Proven performance coatings for abrasion protection and dissimilar metal contact (Nylon11, PPA 571, Polyester, Epoxy)
- Proven and controlled materials including - 201 SS, 304 SS, 316 SS, Alloy 400 & 625
- Quality certified manufacturing process management - ISO9001 with TS 16949



### Identification Systems:

**Indoor/Outdoor:** Durable cable, pipe, fixture and asset identification engineered for extreme environments.

### Products:

- BAND-IT® ID tags, COLOR-IT® banding, stainless steel embossing tape, imprintable stainless steel tags, stainless steel characters and carrier strips

### Benefits:

- Functional in extreme temperatures, UV light exposure, salt spray and chemical exposure
- Long service life
- BAND-FAST® - 201 SS, 304 SS, 316 SS, Alloy 400 & 625
- Quality certified manufacturing process management - ISO9001 with TS 16949
- COLOR-IT® stainless steel banding
- Emboss, engrave or imprintable



# Electrical Applications

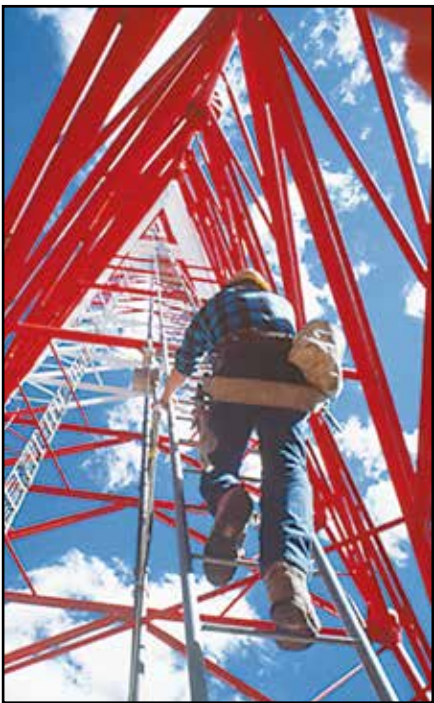

**Engineered Mounting Systems:** Outdoor pole, tower & aerial applications for power, communication infrastructure and alternative energy.

## Products:

- Mounting Hardware: Bolt clamp, mounting plate, stainless steel brackets
- Band and Buckle Systems: Ultra-Lok® system, band and buckle in various materials and widths

## Benefits:

- Superior performance in extreme temperatures, UV light exposure and salt spray
- Corrosion resistant plating on all hardware
- Full tension and heavy duty fastening
- Low installed cost and long service life
- Band & Buckle - 201 SS, 304 SS, 316 SS, Alloy 400 & 625
- Quality certified manufacturing process management - ISO9001 with TS 16949
- Easily applied to pole without drilling
- Ideal for clamping cable splice closures
- Easy to install with no special tools required
- Many banding options

## Certifications *For detailed certification information, see page 44.*



- **Russian Maritime Register of Shipping (RS)**  
- Ball-Lok, Multi-Lok Ties, Tie-Lok® Ties, Mini Tie-Lok® Ties.



- **CE** - Ball-Lok Ties, BAND-IT AE Ties, Multi-Lok Ties, Tie-Lok® Ties, Mini Tie-Lok® Ties



- **DNV** - BAND-IT Ties, BAND-IT AE Ties, BALL-LOK Ties, BALL-LOKT TiesTM, Multi-Lok Ties, Tie-Lok® Ties.



- **Lloyd's Register** - BAND-IT Ties, Multi-Lok Ties, Tie-Lok® Ties.



- **UL** - BALL-LOK Ties, BALL-LOKT TiesTM, BAND-IT AE Ties, Tie-Lok® Ties, Multi-Lok Ties.



- **American Bureau of Shipping (ABS)** A classification sign and construction of new vessels and the integrity of existing vessels and marine structures.

# Cable Restraint Solutions

## WIN BIG With BAND-FAST® Alternative to Cable Cleats!

BAND-IT's BAND-FAST® cable restraint solutions are the perfect alternative to cable cleats for cable management applications that require short circuit protection to IEC61914:2015 Standards.

BAND-IT's BAND-FAST® products cost significantly less than traditional cable cleats! When you need to increase productivity and reduce the risk of injury, start using BAND-FAST® and create a safe and efficient work environment!

### Features & Benefits:

- Increased profitability
- Space saving with lower profile finish
- Logistical and handling benefits (easier to move around site in bulk)
- 316 grade stainless steel
- High Performance PPA 571 coating eliminates the need for protective channel/lining
- Zero Halogen, low smoke & fume
- Materials covered by multiple type approvals
- Standard width 5/8" (15.88mm) - other widths available
- Large diameter adjustment - fewer part numbers to order



### Application Tools:



**C075 Bantam Tool**  
(for PPA Coated)



**C001 BAND-IT Tool**  
(for Uncoated)





# Cable Restraint Solutions

## Electromechanical Force Testing

Tested by independent third party facility to the latest Cable Cleat Standard IEC61914:2015 for resistance to electromechanical force

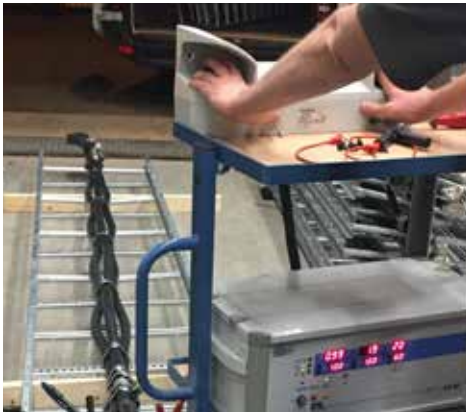

## BAND-FAST - Cable Cleat Alternative

Part No.	Band Ref.	Buckle/Clip Ref.	Width		Length		Single/Double Wrap	*Max Cable OD (single cable config.)		*Max Cable OD (trefoil cable config.)		*Max Cable OD (quadrafoil cable config.)		Pkg Qty	Weight		Passed IEC61914:2015 short Circuit Test in Trefoil up to (kA peak)	
			in	mm	in	mm		in	mm	in	mm	in	mm		lbs	kg		
<b>PPA Coated BAND-FAST® Clamps</b>																		
LFAC-F1015M030-A900	AE435	AE455	5/8	15.88	11.81	300	Single	1.57	40	0.51	13	0.47	12	100	.05	0.025	50.8kA	
LFAC-F1015M040-A900	AE435	AE455	5/8	15.88	15.75	400	Single	2.95	75	1.10	28	0.98	25	100	.06	0.030	50.8kA	
LFAC-F1015M050-A900	AE435	AE455	5/8	15.88	19.68	500	Single	3.93	100	1.69	43	1.45	37	100	.08	0.038	50.8kA	
LFAC-F1015M060-A900	AE435	AE455	5/8	15.88	23.62	600	Single	5.11	130	2.24	57	1.96	50	100	.10	0.045	50.8kA	
LFAC-F1015M070-A900	AE435	AE455	5/8	15.88	27.56	700	Single	6.29	160	2.75	70	2.36	60	100	.11	0.052	50.8kA	
LFFC-F1015M040-A900	AE435	LE155	5/8	15.88	15.75	400	Double	1.57	40	0.51	13	0.47	12	100	.06	0.030	76.3kA	
LFFC-F1015M050-A900	AE435	LE155	5/8	15.88	19.68	500	Double	2.16	55	0.82	21	0.70	18	100	.08	0.038	76.3kA	
LFFC-F1015M060-A900	AE435	LE155	5/8	15.88	23.62	600	Double	2.75	70	1.10	28	0.98	25	100	.10	0.045	76.3kA	
LFFC-F1015M070-A900	AE435	LE155	5/8	15.88	27.56	700	Double	3.34	85	1.37	35	1.22	31	100	.11	0.052	76.3kA	
LFFC-F1015M080-A900	AE435	LE155	5/8	15.88	31.50	800	Double	3.93	100	1.65	42	1.45	37	100	.13	0.060	76.3kA	
LFFC-F1015M100-A900	AE435	LE155	5/8	15.88	39.37	1000	Double	5.11	130	2.24	57	1.96	50	100	.16	0.075	76.3kA	
LFFC-F1015M120-A900	AE435	LE155	5/8	15.88	47.24	1200	Double	6.2	160	2.75	70	2.36	60	100	.19	0.090	76.3kA	
<b>Uncoated BAND-FAST® with Ear-Lokt Buckle</b>																		
LFEC-F1030M050	C405	C455	5/8	15.88	19.68	500	Double	2.16	55	0.82	21	0.70	18	100	.13	0.062	112kA	
LFEC-F1030M060	C405	C455	5/8	15.88	23.62	600	Double	2.75	70	1.10	28	0.98	25	100	.15	0.070	112kA	
LFEC-F1030M070	C405	C455	5/8	15.88	27.56	700	Double	3.34	85	1.37	35	1.22	31	100	.17	0.078	112kA	
LFEC-F1030M080	C405	C455	5/8	15.88	31.50	800	Double	3.93	100	1.65	42	1.45	37	100	.18	0.086	112kA	
LFEC-F1030M100	C405	C455	5/8	15.88	39.37	1000	Double	5.11	130	2.24	57	1.96	50	100	.22	0.103	112kA	
LFEC-F1030M120	C405	C455	5/8	15.88	47.24	1200	Double	6.2	160	2.75	70	2.39	60	100	.26	0.120	112kA	
LFEC-F1230M050	C406	C456	3/4	19.1	19.68	500	Double	2.16	55	0.82	21	0.70	18	100	.17	0.078	120kA	
LFEC-F1230M060	C406	C456	3/4	19.1	23.62	600	Double	2.75	70	1.10	28	0.98	25	100	.19	0.088	120kA	
LFEC-F1230M070	C406	C456	3/4	19.1	27.56	700	Double	3.34	85	1.37	35	1.22	31	100	.21	0.098	120kA	
LFEC-F1230M080	C406	C456	3/4	19.1	31.50	800	Double	3.93	100	1.65	42	1.45	37	100	.23	0.108	120kA	
LFEC-F1230M100	C406	C456	3/4	19.1	39.37	1000	Double	5.11	130	2.24	57	1.96	50	100	.28	0.128	120kA	
LFEC-F1230M120	C406	C456	3/4	19.1	47.24	1200	Double	6.2	160	2.75	70	2.39	60	100	.33	0.150	120kA	

\* Note: Maximum cable OD are for a guide only.

- PPA Coated BAND-FAST™ Clamps with clips have 0.38mm 316SS band thickness (1.2mm thick with coating)
- Uncoated BAND-FAST™ Clamps with Ear-Lokt Buckles have 0.76mm 316SS band thickness
- Uncoated BAND-FAST™ Clamps with Ear-Lokt Buckles should be installed with additional polymeric channel to ensure maximum results

# Electrical Product Matrix

BAND-IT® Electrical Product Solutions											
Product Matrix		Performance Characteristics								Performance Score	
		Speedy Install	Loop Tensile Strength	Salt Spray Resistance	UV Resistance	LSF / Zero Halogen	Temperature Extremes	Long Service Life	Vibration Resistance		Chemical Resistance
Scale - Least Suitable → Most Suitable		1	2	3	4	5	Multiple →	M			
Smooth ID Ball-Lok Ties	Fully Coated 316SS (Epoxy)	5	3	5	2	5	2	3	2	2	29
	Uncoated 316SS	5	3	5	5	5	5	5	2	5	40
	Uncoated 304SS	5	3	3	5	5	5	5	2	4	37
Ball-Lok Ties	Fully Coated 316SS (Epoxy)	5	3	5	2	5	2	3	2	2	29
	Uncoated 316SS	5	3	5	5	5	5	5	2	5	40
	Uncoated 304SS	5	3	3	5	5	5	5	2	4	37
Multi-Lok Ties	Fully Coated (Nylon 11) 316SS	4	2	5	4	5	2	4	4	2	32
	Uncoated 316SS	4	2	5	5	5	5	5	4	5	40
BAND-IT AE Ties	Fully Coated PPA571 316SS	3	3	5	4	5	2	4	5	3	34
Tie-Lok Ties (Standard & Mini)	316SS	4	2	5	5	5	5	5	5	5	41
	304SS	4	2	3	5	5	5	5	5	3	37
316SS PPA Coated Stainless Steel Band	Fully Coated PPA571 316SS	2	4	5	4	5	2	4	5	3	34
All Purpose Band	Fully Coated PPA571 316SS	2	4	5	4	5	2	4	4	3	33
Band & Buckle Systems	201SS, 304SS, 316SS, 317L, Alloy 400, Alloy 625	M	M	M	M	M	M	M	M	M	M
ULTRA-LOK®	1/4 Hard 201 SS	4	5	2	5	5	5	5	5	2	38

# Electrical Product Matrix

Application Match					Description	Approvals & Listings	Page
Marine & Offshore (Outdoor)	Marine, Chemical Plant, Industrial Complex (Indoor)	Utility Pole and Tower	Heavy Mounting Utility Pole and Tower	Mining			
Cable tray Bundling		General Fastening and Mounting					
	X			X	Ball-Lok Tie, 316SS, 0.010" (base metal) 0.016" (coated, Nylon 11)	DNV, Lloyds, GL, RMRS, CE	NL
X	X	X		X	Ball-Lok Tie, 316SS, 0.010"	DNV, Lloyds, GL, RMRS, CE	NL
	X	X		X	Ball-Lok Tie, 304SS, 0.010"	DNV, Lloyds, GL, RMRS, CE	NL
	X			X	Ball-Lokt™ Tie, 316SS, 0.010 CTD Black Epoxy	UL, DNV	26,27
X	X	X		X	Ball-Lokt™ Tie, 316SS, 0.010"	UL, DNV	26,27
	X	X		X	Ball-Lokt™ Tie, 304SS, 0.010	UL, DNV	26,27
X	X	X		X	Multi-Lok Tie, 316SS, 0.011" (base metal) 0.018" (coated, Nylon 11)	DNV, Lloyds, GL, RMRS, CE, UL	25
X	X	X		X	Multi-Lok Tie, 316SS, 0.011" Thickness	DNV, Lloyds, GL, RMRS, CE, UL	25
X	X	X		X	BAND-IT® Tie, 316SS, 0.015" (base metal) 0.040" (PPA 571)	DNV, Lloyds, GL, RMRS, CE	28
X	X	X		X	Tie-Lok® Tie SID, 316SS, 0.015" Thickness	UL, DNV <sup>(UK)</sup> , GL <sup>(UK)</sup> , Lloyds <sup>(UK)</sup> , RMRS <sup>(UK)</sup>	24
	X	X		X	Tie-Lok® Tie, SID, 304SS, 0.020" Thickness	UL, DNV <sup>(UK)</sup> , GL <sup>(UK)</sup> , Lloyds <sup>(UK)</sup> , RMRS <sup>(UK)</sup>	24
X	X	X		X	Coated Band, 316SS, 0.015" (base metal) 0.045" (coated, PPA571) x 82.5'	DNV, Lloyds, ABS, RMRS, CE, GL	8
X	X			X	All Purpose Band, 316SS 0.030" (base metal) 0.050" (CTD, PPA571) x 82.5'	DNV, Lloyds, ABS, RMRS, GL	9
X	X	X	X	X	1/4", 3/8", 1/2", 5/8", 3/4", 1", 1-1/4" Widths 0.015", 0.020, 0.025, 0.030, 0.044 thicknesses available		5-9
		X	X	X	Ultra-Lok® Band, 201SS 1/4 Hard		14

# BAND-IT Certifications & Approvals



**Det Norske Veritas - Germanischer Lloyd (DNV-GL)** The world's leading classification society and recognized advisor for the maritime industry. DNV-GL enhances safety, quality, energy efficiency and environmental performance of the global shipping industry - across all vessel types and offshore structures. DNV-GL invests heavily in research and development to find solutions, together with the industry that address strategic, operational and/or regulatory challenges.



**American Bureau of Shipping (ABS)** A classification sign and construction of new vessels and the integrity of existing vessels and marine structures.



**Lloyd's Register Group** A maritime classification society and independent risk management organization providing risk assessment and mitigation services and management systems certification. Historically, as Lloyd's Register of Shipping, it was a specifically maritime organization.



**Russian Maritime Register of Shipping (RS)** The activities of Russian Maritime Register of Shipping (RS) are aimed at providing the safety of navigation, safety of life at sea, security of ships, safe carriage of cargo, environmental safety of ships, prevention of pollution from ships, performance of authorizations issued by Administrations and customers. RS develops and continually improves the RS rules and guidelines in compliance with requirements of the international standards to ensure the safety at sea and pollution prevention.

The RS task is both to maintain its own quality management system at the highest possible level and to promote also implementation of high technical standards in design of ships, shipbuilding and shipping industry using its unique experience in ensuring maritime safety.



**Underwriters Laboratories (UL)** An independent product safety certification organization that develops standards and test procedures for products, materials, components, assemblies, tools and equipment, chiefly dealing with product safety.

**Aramco 9COM** BAND-IT® is registered as an Aramco 9COM manufacturer.



**ISO TS 16949** ISO/TS 16949 is designed to address quality management in the automotive supply chain. It is based on the eight quality management principles: customer focus, leadership, involvement of people, process approach, system approach to management, continual improvement, fact-based decision making, and mutually beneficial supplier relationships. In addition, ISO/TS 16949 focuses on customer specific requirements.

**ISO 14001** The ISO 14000 environmental management standards exist to help organizations (a) minimize how their operations (processes etc.) negatively affect the environment (i.e. cause adverse changes to air, water, or land); (b) comply with applicable laws, regulations, and other environmentally oriented requirements, and (c) continually improve in the above.

**ISO 9001** The ISO 9000 family of standards relate to quality management systems and are designed to help organizations ensure they meet the needs of customers and other stakeholders. The standards are published by ISO, the International Organization for Standardization and available through National standards bodies. ISO 9000 deals with the fundamentals of quality management systems, including the eight management principles on which the family of standards is based. ISO 9001 deals with the requirements that organizations wishing to meet the standard have to fulfill.



**British Standards Institution (BSI)** Is the business standards company that helps organizations all over the world make excellence a habit. We have many varied partners. These include international standards bodies, such as ISO, external consultants who help our clients and professional affiliations.



**CE** CE marking is a mandatory conformity mark for products placed on the market in the European Economic Area (EEA). With the CE marking on a product the manufacturer ensures that the product conforms with the essential requirements of the applicable EC directives. The letters “CE” stand for “Conformité Européenne” (“European Conformity”).



**United States Coast Guard** Type approval is the primary process for equipment and materials to receive Coast Guard approval. For equipment or materials to receive Type Approval, they must be demonstrated to comply with the relevant requirements in the regulations, successfully complete the specified tests, and be enrolled in a quality control or follow up program as required.



**GOST-R Approval** GOST (Russian: ROCT) refers to a set of technical standards maintained by the Euro-Asian Council for Standardization, Metrology and Certification (EASC, a regional standards organization operating under the auspices of the Commonwealth of Independent States (CIS).

## Definitions

**Corrosion Resistance** - The ability of a material to withstand degradation in specific environments.

**Loop Tensile Strength** - The maximum amount of force, applied radially, an installed clamp/tie will withstand prior to failure.

**Nylon 11** - Non-toxic polymer cable tie coating resistant to stress cracking, abrasion, impact, salt spray and typical airborne pollutants. When subjected to fire, this coating is halogen-free and produces low amounts of smoke.

**Polyester** - A high performance black polyester, non-toxic polymer coating for rolled band resistant to stress cracking, abrasion, impact, salt spray and typical airborne pollutants. When subjected to fire, this coating is halogen free and produces low amounts of smoke.

**PPA 571** - A non-toxic polymer coating for rolled band resistant to stress cracking, abrasion, impact, salt spray and typical airborne pollutants. When subjected to fire, this coating is halogen free and produces low amounts of smoke.

**Black Epoxy** - Resistant to chemical and salt water environments.

**Production Tool** - Power tools to install band clamps and tie products consistently.

# BAND-IT® Metals Data

All values in table are reference only.

Material	201 Stainless Steel	201 1/4 Hard	202 Stainless Steel	301 Stainless Steel	302 Stainless Steel	304 Stainless Steel	316 Stainless Steel	317L 1/4 Hard Stainless Steel	321 Stainless Steel	200/300 Series Stainless Steel	Alloy 400	Alloy 625	Titanium GR1
Specification													
UNS Designation	S20100	S20100	S20200	S30100	S30200	S30400	S31600	S31703	S32100	---	N04400	N06625	R50250
ASTM	A 666	A 666	A 666	A 666	A 666	A 666	A 666	A 240	A 240	---	B 127	B 443	B 265
Principal Alloying Elements, %													
C	.015 Max	.015 Max	.015 Max	.15 Max	.15 Max	.08 Max	.08 Max	.03 Max	.08 Max	---	.3 Max	.10 Max	.08 Max
Mn	5.50 - 7.50	5.50 - 7.50	7.5-10.0	2.0 Max	2.0 Max	2.0 Max	2.0 Max	2.0 Max	2.0 Max	---	2.0 Max	.50 Max	---
P	.06 Max	.06 Max	.06 Max	.045 Max	.045 Max	.045 Max	.045 Max	.045 Max	.045 Max	---	---	.015 Max	---
S	.03 Max	.03 Max	.03 Max	.030 Max	.030 Max	.030 Max	.030 Max	.030 Max	.030 Max	---	0.024 Max	.015 Max	---
Si	.75 Max	.75 Max	.75 Max	1.00 Max	.75 Max	.75 Max	.75 Max	.75 Max	.75 Max	---	0.5 Max	50 Max	---
Cr	16.0-18.0	16.0-18.0	17.0-19.0	16.0-18.0	17.0-19.0	18.0-20.0	16.0-18.0	18.0-20.0	17.0-19.0	---	---	20.0-23.0	---
Ni	3.50-5.50	3.50-5.50	4.0-6.0	6.0-8.0	8.0-10.0	8.0-10.5	10.0-14.0	11.0-15.0	9.0-12.0	---	63.0 Min	58.0 Min	---
N	.25 Max	.25 Max	.25 Max	.10 Max	---	.10 Max	---	.10 Max	.10 Max	---	---	---	.03 Max
O	---	---	---	---	---	---	---	---	---	---	---	---	.18 Max
H	---	---	---	---	---	---	---	---	---	---	---	---	.015 Max
Mo	---	---	---	---	---	---	2.0-3.0	3.0-4.0	---	---	---	8.0-10.0	---
Cu	---	---	---	---	---	---	---	---	---	---	28.0-34.0	---	---
Fe	---	---	---	---	---	---	---	---	---	---	2.5 Max	5.0 Max	.20 Max
Ti	---	---	---	---	---	---	---	---	---	---	---	0.40 Max	Balance
Zn	---	---	---	---	---	---	---	---	---	---	---	0.40 Max	Balance
Al	---	---	---	---	---	---	---	---	---	---	---	---	---
Physical Properties													
Density, Lb/Cu. In.	0.287	0.287	0.287	0.290	0.290	0.290	0.290	0.290	0.286	0.287	0.319	0.305	0.163
Structure	Austenitic	Austenitic	Austenitic	Austenitic	Austenitic	Austenitic	Austenitic	Austenitic	---	Austenitic	---	---	Alpha
Melting Range	2550 - 2650°F	2550- 2650°F	2550- 2650°F	2550- 2590°F	2550- 2590°F	2550- 2590°F	2540 - 2630°F	2540 - 2630°F	2550 - 2635°F	2550- 2650°F	2370- 2460°F	2500 - 2550°F	2500 - 2550°F
Electrical Properties	Non-Magnetic	Non-Magnetic	Non-Magnetic	Non-Magnetic	Non-Magnetic	Non-Magnetic	Non-Magnetic	Non-Magnetic	Non-Magnetic	Non-Magnetic	Slightly Magnetic	Non-Magnetic	Non-Magnetic
Mechanical Properties													
Rockwell Hardness	100 Rb Max	---	100 Rb Max	95 Rb Max	92 Rb Max	92 Rb Max	95 Rb Max	95 Rb Max	95 Rb Min	70-95R	68 Rb Max	88-94R	64-70R
Ultimate Tensile Strength (PSI)	95,000	125,000	90,000	75,000	75,000	75,000	75,000	115,000	75,000	75,000	70,000	120,000	35,000
Yield Strength (PSI)	45,000	75,000	38,000	30,000	30,000	30,000	40,000	75,000	30,000	30,000	28,000	60,000	20,000
% of Elongation in 2 inches, Min	40	25	40	40	40	40	35	10	40	30	35	30	24
Corrosion Resistance													
Mild Atmospheric and Fresh Water	Good	Good	Good	Good	Very Good	Very Good	Excellent	Excellent	Excellent	Good	Good	Good	Good
Industrial Atmosphere	Good	Good	Good	Good	Very Good	Very Good	Very Good	Very Good	Very Good	Good	Good	Good	Good
Marine Atmosphere	Fair	Fair	Fair	Fair	Good	Good	Very Good	Very Good	Very Good	Fair	Excellent	Excellent	Good
Salt Water	No	No	No	No	No	No	Good	Good	Good	No	Excellent	Excellent	Good
Mild Chemical	Fair	Fair	Fair	Fair	Good	Good	Good	Very Good	Good	Fair	Good	Good	Good
Oxidizing Chemical	Fair	Fair	Fair	Fair	Good	Good	Good	Good	Good	Fair	Good	Good	Excellent
Reducing Chemical	No	No	No	No	No	No	Good	Good	Good	No	Good	Good	Fair



# **BAND-IT<sup>®</sup>**

**ENGINEERED FASTENING SOLUTIONS**

**More Clamps**

**More Markets**

**More Solutions!**

**Aerospace**  
**Automotive**  
**Cable TV**  
**Cable Management**  
**Coal Power**  
**Construction**  
**Electrical**  
**Government**  
**Hose**  
**Insulation**  
**Offshore**  
**Oil & Gas**  
**Marine**  
**Military**  
**Municipal**  
**Petrochemical**  
**Power Plants**  
**Refineries**  
**Ship Building**  
**Subsea**  
**Telecommunications**  
**Traffic**  
**Utility**



**IDEX**

Copyright BAND-IT<sup>®</sup>  
A Unit of IDEX Corporation  
Denver, Colorado U.S.A.

Product Solutions Guide 2018. All rights reserved.