

MegaCrimp® Couplings

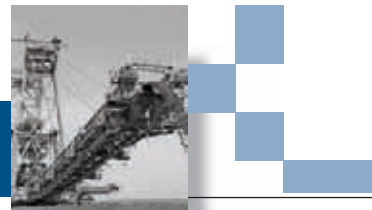

Male Pipe (NPTF - 30° Cone Seat)

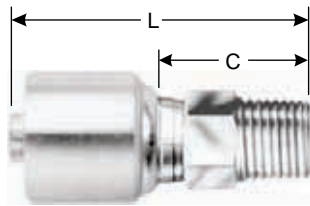

H1

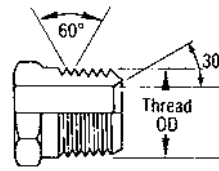

Descr.	Prod. No.	⊖			H1	H2	L		C		Std. Pack
		"	mm				"	mm	"	mm	
STANDARD PACK											
4G-2MP	7100-10025	1/4	6.4	1/8-27	1/2	—	1.97	50.0	.94	24.0	5
4G-4MP	7100-10035	1/4	6.4	1/4-18	9/16	—	2.17	55.0	1.14	29.0	5
4G-6MP	7100-10045	1/4	6.4	3/8-18	11/16	—	2.17	55.0	1.14	29.0	5
4G-8MP	7100-10055	1/4	6.4	1/2-14	7/8	—	2.44	62.0	1.42	36.0	1
5G-4MP	7100-00065	5/16	7.9	1/4-18	5/8	—	2.28	58.0	1.18	30.0	1
5G-6MP	7100-10065	5/16	7.9	3/8-18	5/8	—	1.22	55.5	1.08	27.5	1
6G-4MP	7100-10075	3/8	9.5	1/4-18	5/8	—	2.32	59.0	1.22	31.1	5
6G-6MP	7100-10085	3/8	9.5	3/8-18	11/16	—	2.32	59.0	1.22	31.1	5
6G-8MP	7100-10095	3/8	9.5	1/2-14	7/8	—	2.52	64.0	1.42	36.1	5
8G-6MP	7100-00105	1/2	12.7	3/8-18	13/16	—	2.72	69.0	1.24	31.5	5
8G-8MP	7100-00115	1/2	12.7	1/2-14	7/8	—	2.78	73.0	1.40	35.5	5
8G-12MP	7100-00125	1/2	12.7	3/4-14	1 1/16	—	2.95	75.0	1.48	37.5	5
10G-8MP	7100-00225	5/8	15.8	1/2-14	15/16	—	2.95	75.0	1.48	37.5	1
10G-12MP	7100-00235	5/8	15.8	3/4-14	1 1/16	—	2.89	73.5	1.42	36.0	1
12G-8MP	7100-00155	3/4	19.0	1/2-14	1 1/16	—	3.46	88.0	1.46	37.0	1
12G-12MP	7100-00165	3/4	19.0	3/4-14	1 1/16	—	3.46	88.0	1.46	37.0	5
12G-16MP	7100-00175	3/4	19.0	1-11 1/2	1 3/8	—	3.78	96.0	1.77	45.0	1
16G-12MP	7100-00195	1	25.4	3/4-14	1 3/8	—	3.94	100.0	1.70	43.2	1
16G-16MP	7100-00205	1	25.4	1-11 1/2	1 3/8	—	4.11	104.5	1.88	47.7	1
20G-20MP	7100-00215	1 1/4	31.7	1 1/4-11 1/2	1 3/4	—	4.45	113.0	2.13	54.0	1
BULK PACK											
4G-2MPXBULK	7100-1002	1/4	6.4	1/8-27	1/2	—	1.97	50.0	.94	24.0	370
4G-4MPXBULK	7100-1003	1/4	6.4	1/4-18	9/16	—	2.17	55.0	1.14	29.0	300
4G-6MPXBULK	7100-1004	1/4	6.4	3/8-18	11/16	—	2.17	55.0	1.14	29.0	300
4G-8MPXBULK	7100-1005	1/4	6.4	1/2-14	7/8	—	2.44	62.0	1.42	36.0	100
6G-4MPXBULK	7100-1007	3/8	9.5	1/4-18	5/8	—	2.32	59.0	1.22	31.1	275
6G-6MPXBULK	7100-1008	3/8	9.5	3/8-18	11/16	—	2.32	59.0	1.22	31.1	200
6G-8MPXBULK	7100-1009	3/8	9.5	1/2-14	7/8	—	2.52	64.0	1.42	36.1	200
8G-6MPXBULK	7100-0010	1/2	12.7	3/8-18	13/16	—	2.72	69.0	1.24	31.5	175
8G-8MPXBULK	7100-0011	1/2	12.7	1/2-14	7/8	—	2.78	73.0	1.40	35.5	150
8G-12MPXBULK	7100-0012	1/2	12.7	3/4-14	1 1/16	—	2.95	75.0	1.48	37.5	100
10G-8MPXBULK	7100-0022	5/8	15.8	1/2-14	15/16	—	2.95	75.0	1.48	37.5	125
10G-12MPXBULK	7100-0023	5/8	15.8	3/4-14	1 1/16	—	2.89	73.5	1.42	36.0	100
12G-8MPXBULK	7100-0015	3/4	19.0	1/2-14	1 1/16	—	3.46	88.0	1.46	37.0	75
12G-12MPXBULK	7100-0016	3/4	19.0	3/4-14	1 1/16	—	3.46	88.0	1.46	37.0	60
12G-16MPXBULK	7100-0017	3/4	19.0	1-11 1/2	1 3/8	—	3.78	96.0	1.77	45.0	50
16G-12MPXBULK	7100-0019	1	25.4	3/4-14	1 3/8	—	3.94	100.0	1.70	43.2	25
16G-16MPXBULK	7100-0020	1	25.4	1-11 1/2	1 3/8	—	4.11	104.5	1.88	47.7	30
20G-20MPXBULK	7100-0021	1 1/4	31.7	1 1/4-11 1/2	1 3/4	—	4.45	113.0	2.13	54.0	20

EQUIPMENT

HOSE/CPLG. SELECTION

GLOBAL SPIRAL COUPLINGS

PCM/PCS FERRULES

MEGACRIMP COUPLINGS

POWER CRIMP COUPLINGS

LOW PRESSURE COUPLINGS

POLARSEAL COUPLINGS

C14 COUPLINGS

PCTS THERMO-PLASTIC COUPLINGS

FIELD ATTACHABLE G1 & G2 COUPLINGS

FIELD ATTACHABLE C5 COUPLINGS

SURELOK AIR BRAKE COUPLINGS

QUICK DISCONNECT COUPLERS

NEW BALL VALVES

ACCESSORIES

EQUIPMENT AND PARTS





MegaCrimp® Couplings

Male Pipe Long Nose

For use with J2AT Jack Hose and special high-pressure applications.

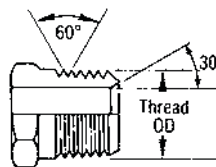
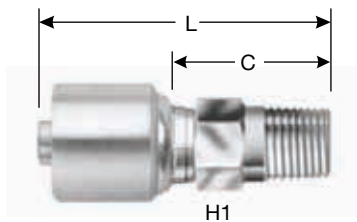

Descr.	Prod. No.	⊖		🌀	H1	H2	L		C		Std. Pack
		"	mm		"	"	"	mm	"	mm	
STANDARD PACK											
4G-4MPLN	7100-16615	1/4	6.4	1/4-18	9/16	—	2.56	65.0	1.54	39.0	1
4G-6MPLN	7100-16625	1/4	6.4	3/8-18	11/16	—	2.56	65.0	1.54	39.0	1
6G-4MPLN	7100-16645	3/8	9.5	1/4-18	5/8	—	2.72	69.0	1.62	41.1	1
6G-6MPLN	7100-16635	3/8	9.5	3/8-18	11/16	—	2.72	69.0	1.62	41.1	1
BULK PACK											
4G-4MPLNXBULK	7100-1661	1/4	6.4	1/4-18	9/16	—	2.56	65.0	1.54	39.0	200
4G-6MPLNXBULK	7100-1662	1/4	6.4	3/8-18	11/16	—	2.56	65.0	1.54	39.0	175
6G-6MPLNXBULK	7100-1663	3/8	9.5	3/8-18	11/16	—	2.72	69.0	1.62	41.1	150

Male Pipe Swivel (NPTF - Without 30° Cone Seat)

NOT TO BE USED AS A LIVE SWIVEL.

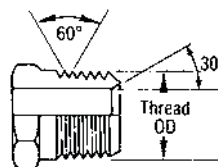
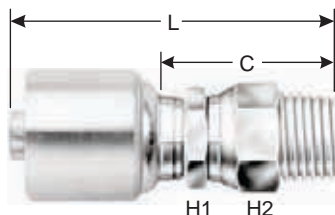

Descr.	Prod. No.	⊖		🌀	H1	H2	L		C		Std. Pack
		"	mm		"	"	"	mm	"	mm	
STANDARD PACK											
4G-2MPX	7100-10245	1/4	6.4	1/8-27	1/2	1/2	2.39	60.8	1.37	24.8	1
4G-4MPX	7100-10255	1/4	6.4	1/4-18	1/2	7/8	2.61	66.3	1.58	40.2	5
4G-6MPX	7100-10265	1/4	6.4	3/8-18	5/8	7/8	2.74	69.5	1.71	43.5	1
4G-8MPX	7100-10275	1/4	6.4	1/2-14	3/4	1	2.97	75.4	1.94	49.4	1
6G-4MPX	7100-10285	3/8	9.5	1/4-18	5/8	7/8	2.87	72.8	.85	21.7	5
6G-6MPX	7100-10295	3/8	9.5	3/8-18	2 1/2	7/8	2.81	71.5	1.72	43.6	5
6G-8MPX	7100-10305	3/8	9.5	1/2-14	3/4	1	3.05	77.5	1.95	49.5	5
8G-6MPX	7100-00315	1/2	12.7	3/8-18	13/16	7/8	3.23	82.0	1.76	44.6	1
8G-8MPX	7100-00325	1/2	12.7	1/2-14	13/16	1	3.42	86.9	1.94	49.4	5
10G-12MPX	7100-00335	5/8	15.8	3/4-14	1 1/16	1 5/16	3.48	88.5	2.01	51.1	1
12G-8MPX	7100-00345	3/4	19.1	1/2-14	1 1/16	1	3.97	100.9	1.96	49.9	1
12G-12MPX	7100-00355	3/4	19.1	3/4-14	1 1/16	1 5/16	4.02	102.0	2.01	51.0	1
16G-16MPX	7100-00365	1	25.4	1-11 1/2	1 3/8	1 5/8	4.73	120.2	2.50	63.4	1
BULK PACK											
4G-4MPX XBULK	7100-1025	1/4	6.4	1/4-18	1/2	7/8	2.61	66.3	1.58	40.2	300
4G-6MPX XBULK	7100-1026	1/4	6.4	3/8-18	5/8	7/8	2.74	69.5	1.71	43.5	100
6G-4MPX XBULK	7100-1028	3/8	9.5	1/4-18	5/8	7/8	2.87	72.8	.85	21.7	100







Male Pipe Swivel (NPTF - Without 30° Cone Seat) - Cont'd

Descr.	Prod. No.	⊖			H1	H2	L		C		Std. Pack
		"	mm				"	mm	"	mm	
6G-6MPX XBULK	7100-1029	3/8	9.5	3/8-18	2 1/2	7/8	2.81	71.5	1.72	43.6	175
6G-8MPX XBULK	7100-1030	3/8	9.5	1/2-14	3/4	1	3.05	77.5	1.95	49.5	125
8G-6MPX XBULK	7100-0031	1/2	12.7	3/8-18	13/16	7/8	3.23	82.0	1.76	44.6	100
8G-8MPX XBULK	7100-0032	1/2	12.7	1/2-14	13/16	1	3.42	86.9	1.94	49.4	125
12G-8MPX XBULK	7100-0034	3/4	19.1	1/2-14	1 1/16	1	3.97	100.9	1.96	49.9	75
12G-12MPX XBULK	7100-0035	3/4	19.1	3/4-14	1 1/16	1 5/16	4.02	102.0	2.01	51.0	50
16G-16MPX XBULK	7100-0036	1	25.4	1-11 1/2	1 3/8	1 5/8	4.73	120.2	2.50	63.4	25

Male Pipe Swivel - 90° Block (NPTF - Without 30° Cone Seat)

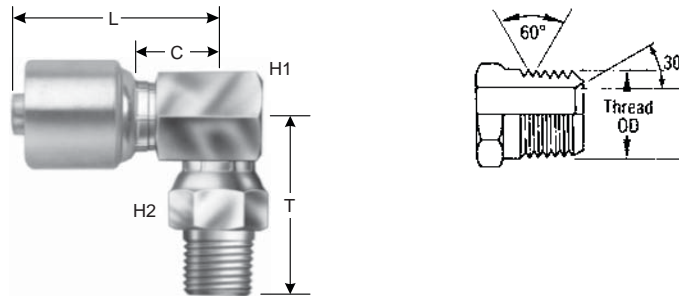
NOT TO BE USED AS A LIVE SWIVEL.



Descr.	Prod. No.	⊖			H1	H2	T		L		C		Std. Pack
		"	mm				"	mm	"	mm	"	mm	
STANDARD PACK													
4G-2MPX90	7100-10365	1/4	6.4	1/8-27	11/16	1/2	1.20	30.5	2.12	53.9	.72	18.4	1
4G-4MPX90	7100-10375	1/4	6.4	1/4-18	11/16	11/16	1.63	41.3	1.75	44.5	.72	18.4	1
4G-6MPX90	7100-10385	1/4	6.4	3/8-18	11/16	7/8	1.73	43.9	1.82	46.3	.80	20.2	1
6G-4MPX90	7100-10395	3/8	9.5	1/4-18	3/4	11/16	1.66	42.1	1.95	49.6	.85	21.7	1
6G-6MPX90	7100-10405	3/8	9.5	3/8-18	3/4	7/8	1.76	44.8	1.95	49.6	.85	21.7	1
6G-8MPX90	7100-10415	3/8	9.5	1/2-14	3/4	1	1.93	49.1	1.96	49.7	.85	21.7	1
8G-6MPX90	7100-07135	1/2	12.7	3/8-18	1	7/8	1.89	48.0	2.55	64.7	1.07	27.2	1
8G-8MPX90	7100-00425	1/2	12.7	1/2-14	1	1	2.06	52.3	2.55	64.7	1.07	27.2	1
12G-12MPX90	7100-00435	3/4	19.1	3/4-14	1 3/8	1 15/16	2.30	58.4	3.18	80.7	1.17	29.7	1
BULK PACK													
4G-4MPX90XBULK	7100-1037	1/4	6.4	1/4-18	11/16	11/16	1.63	41.3	1.75	44.5	.72	18.4	200
4G-6MPX90XBULK	7100-1038	1/4	6.4	3/8-18	11/16	7/8	1.73	43.9	1.82	46.3	.80	20.2	150
6G-6MPX90XBULK	7100-1040	3/8	9.5	3/8-18	3/4	7/8	1.76	44.8	1.95	49.6	.85	21.7	100
6G-8MPX90XBULK	7100-1041	3/8	9.5	1/2-14	3/4	1	1.93	49.1	1.96	49.7	.85	21.7	150
8G-8MPX90XBULK	7100-0042	1/2	12.7	1/2-14	1	1	2.06	52.3	2.55	64.7	1.07	27.2	75
12G-12MPX90XBULK	7100-0043	3/4	19.1	3/4-14	1 3/8	1 15/16	2.30	58.4	3.18	80.7	1.17	29.7	30

EQUIPMENT

HOSE/CPLG. SELECTION

GLOBAL SPIRAL COUPLINGS

PCM/PCS FERRULES

MEGACRIMP COUPLINGS

POWER CRIMP COUPLINGS

LOW PRESSURE COUPLINGS

POLARSEAL COUPLINGS

C14 COUPLINGS

PCTS THERMO-PLASTIC COUPLINGS

FIELD ATTACHABLE G1 & G2 COUPLINGS

FIELD ATTACHABLE C5 COUPLINGS

SURELOK AIR BRAKE COUPLINGS

QUICK DISCONNECT COUPLERS

NEW BALL VALVES

ACCESSORIES

EQUIPMENT AND PARTS





MegaCrimp® Couplings

Male Pipe Swivel - 90° Long Block (NPTF - Without 30° Cone Seat)

NOT TO BE USED AS A LIVE SWIVEL.

These couplings have a longer reach (L dimension) to accommodate the OmniCrimp® 21 crimper.

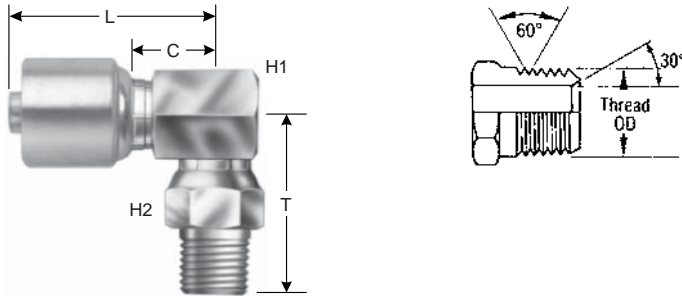

Descr.	Prod. No.	⊖		🌀	H1	H2	T		L		C		Std. Pack
		"	mm		"	"	"	mm	"	mm	"	mm	
STANDARD PACK													
6G-8MPX90L	7100-00445	3/8	9.5	1/2-14	3/4	1	1.93	49.1	3.41	86.5	1.94	49.3	1
8G-8MPX90L	7100-00455	1/2	12.7	1/2-14	1	1	2.06	52.3	3.76	95.5	1.80	45.6	1
12G-12MPX90L	7100-00475	3/4	19.1	3/4-14	1 3/8	1 5/16	2.30	58.4	3.93	99.7	1.92	48.7	1

Female Pipe (NPTF - Without 30° Cone Seat)

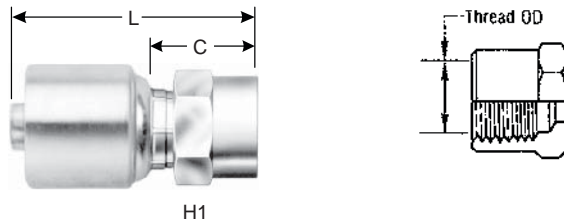

Descr.	Prod. No.	⊖		🌀	H1	H2	L		C		Std. Pack
		"	mm		"	"	"	mm	"	mm	
STANDARD PACK											
4G-2FP	7100-10485	1/4	6.4	1/8-27	9/16	—	1.74	44.3	.72	18.3	1
4G-4FP	7100-10495	1/4	6.4	1/4-18	11/16	—	1.99	50.5	.96	24.5	1
4G-6FP	7100-10505	1/4	6.4	3/8-18	13/16	—	1.99	50.5	.96	24.5	1
6G-4FP	7100-10515	3/8	9.5	1/4-18	11/16	—	2.01	51.0	.91	23.1	1
6G-6FP	7100-10525	3/8	9.5	3/8-18	13/16	—	2.07	52.5	.97	24.6	5
6G-8FP	7100-10535	3/8	9.5	1/2-14	1	—	2.25	57.1	1.15	29.2	1
8G-6FP	7100-00545	1/2	12.7	3/8-18	13/16	—	2.46	62.5	.98	25.0	1
8G-8FP	7100-00555	1/2	12.7	1/2-14	1	—	2.64	67.0	1.16	29.5	5
12G-12FP	7100-00565	3/4	19.0	3/4-14	1 1/4	—	3.23	82.0	1.22	31.0	1
BULK PACK											
4G-2FPXBULK	7100-1048	1/4	6.4	1/8-27	9/16	—	1.74	44.3	.72	18.3	250
4G-4FPXBULK	7100-1049	1/4	6.4	1/4-18	11/16	—	1.99	50.5	.96	24.5	300
4G-6FPXBULK	7100-1050	1/4	6.4	3/8-18	13/16	—	1.99	50.5	.96	24.5	100
6G-4FPXBULK	7100-1051	3/8	9.5	1/4-18	11/16	—	2.01	51.0	.91	23.1	150
6G-6FPXBULK	7100-1052	3/8	9.5	3/8-18	13/16	—	2.07	52.5	.97	24.6	200
6G-8FPXBULK	7100-1053	3/8	9.5	1/2-14	1	—	2.25	57.1	1.15	29.2	175
8G-6FPXBULK	7100-0054	1/2	12.7	3/8-18	13/16	—	2.46	62.5	.98	25.0	100







Female Pipe (NPTF - Without 30° Cone Seat) - Cont'd

Descr.	Prod. No.	⌀			H1	H2	L		C		Std. Pack
		"	mm		"	"	"	mm	"	mm	
8G-8FPXBULK	7100-0055	1/2	12.7	1/2-14	1	—	2.64	67.0	1.16	29.5	150
12G-12FPXBULK	7100-0056	3/4	19.0	3/4-14	1 1/4	—	3.23	82.0	1.22	31.0	60

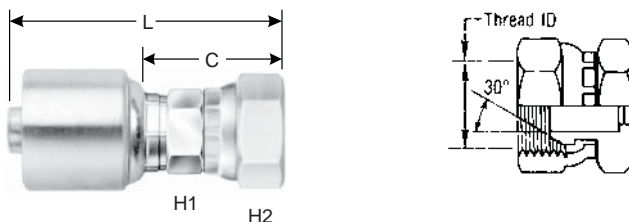
Female Pipe Swivel (NPSM - 30° Cone Seat)



Descr.	Prod. No.	⌀			H1	H2	L		C		Std. Pack
		"	mm		"	"	"	mm	"	mm	
STANDARD PACK											
4G-4FPX	7100-10575	1/4	6.4	1/4-18	1/2	11/16	2.24	57.0	1.22	30.9	1
6G-6FPX	7100-10585	3/8	9.5	3/8-18	5/8	7/8	2.37	60.2	1.27	32.3	5
6G-8FPX	7100-10595	3/8	9.5	1/2-14	13/16	1	2.56	64.9	1.46	37.0	1
8G-8FPX	7100-00595	1/2	12.7	1/2-14	13/16	1	2.81	71.4	1.33	33.9	5
12G-12FPX	7100-00605	3/4	19.0	3/4-14	1 1/16	1 1/4	3.72	94.4	1.71	43.4	1
16G-16FPX	7100-00615	1	25.4	1-11 1/2	1 3/8	1 1/2	4.11	104.3	1.87	47.5	1
20G-20FPX	7100-00625	1 1/4	31.8	1 1/4-17/32	1 3/4	1 7/8	4.50	114.4	2.18	55.4	1
BULK PACK											
4G-4FPX XBULK	7100-1057	1/4	6.4	1/4-18	1/2	11/16	2.24	57.0	1.22	30.9	110
6G-6FPX XBULK	7100-1058	3/8	9.5	3/8-18	5/8	7/8	2.37	60.2	1.27	32.3	180
8G-8FPX XBULK	7100-0059	1/2	12.7	1/2-14	13/16	1	2.81	71.4	1.33	33.9	100
12G-12FPX XBULK	7100-0060	3/4	19.0	3/4-14	1 1/16	1 1/4	3.72	94.4	1.71	43.4	60
16G-16FPX XBULK	7100-0061	1	25.4	1-11 1/2	1 3/8	1 1/2	4.11	104.3	1.87	47.5	35

Male O-Ring Boss

SAE J1926/3 ISO 11926-3 Light-Duty (L Series) Stud End.

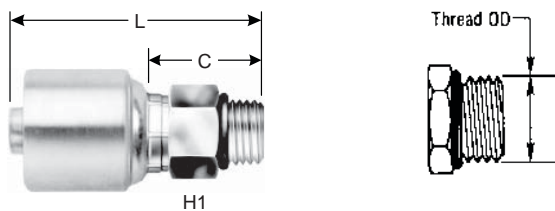

Descr.	Prod. No.	⌀			H1	H2	L		C		Std. Pack
		"	mm		"	"	"	mm	"	mm	
STANDARD PACK											
4G-4MB	7100-12205	1/4	6.4	7/16-20	9/16	—	1.99	50.5	.96	24.5	1
4G-5MB	7100-12215	1/4	6.4	1/2-20	5/8	—	1.99	50.5	.96	24.5	1
4G-6MB	7100-12225	1/4	6.4	9/16-18	11/16	—	2.05	52.0	1.02	26.0	1
6G-5MB	7100-12285	3/8	9.5	1/2-20	1/16	—	2.05	52.0	.95	24.1	1
6G-6MB	7100-13235	3/8	9.5	9/16-18	11/16	—	2.07	52.5	.96	24.5	1



- EQUIPMENT
- HOSE/CPLG. SELECTION
- GLOBAL SPIRAL COUPLINGS
- PCM/PCS FERRULES
- MEGACRIMP COUPLINGS**
- POWER CRIMP COUPLINGS
- LOW PRESSURE COUPLINGS
- POLAR SEAL COUPLINGS
- C14 COUPLINGS
- PCTS THERMO-PLASTIC COUPLINGS
- FIELD ATTACHABLE G1 & G2 COUPLINGS
- FIELD ATTACHABLE C5 COUPLINGS
- SURELOK AIR BRAKE COUPLINGS
- QUICK DISCONNECT COUPLERS
- NEW BALL VALVES
- ACCESSORIES
- EQUIPMENT AND PARTS

MegaCrimp® Couplings



EQUIPMENT

HOSE/CPLG. SELECTION

GLOBALSPIRAL COUPLINGS

PCM/PCS FERRULES

MEGACRIMP COUPLINGS

POWER CRIMP COUPLINGS

LOW PRESSURE COUPLINGS

POLARSEAL COUPLINGS

C14 COUPLINGS

PCTS THERMO-PLASTIC COUPLINGS

FIELD ATTACHABLE G1 & G2 COUPLINGS

FIELD ATTACHABLE C5 COUPLINGS

SURELOK AIR BRAKE COUPLINGS

QUICK DISCONNECT COUPLERS

NEW BALL VALVES

ACCESSORIES

EQUIPMENT AND PARTS

Male O-Ring Boss - Cont'd

Descr.	Prod. No.	⊖			H1	H2	L		C		Std. Pack
		"	mm		"	"	"	mm	"	mm	
6G-8MB	7100-13245	3/8	9.5	3/4-16	7/8	—	2.17	55.0	1.07	27.1	1
6G-10MB	7100-12255	3/8	9.5	7/8-14	1	—	2.22	56.5	1.13	28.6	1
6G-12MB	7100-12265	3/8	9.5	1 1/16-12	1 1/4	—	2.42	61.5	1.32	33.6	1
8G-8MB	7100-13275	1/2	12.7	7/8-14	7/8	—	2.54	64.5	1.06	27.0	1
8G-10MB	7100-13285	1/2	12.7	7/8-14	1	—	2.58	65.5	1.10	28.0	1
8G-12MB	7100-13295	1/2	12.7	1 1/16-12	1 1/4	—	2.78	70.5	1.30	33.0	1
10G-8MB	7100-02305	5/8	15.8	3/4-16	1 1/4	—	2.83	72.0	1.36	34.5	1
10G-10MB	7100-13315	5/8	15.8	7/8-14	1	—	2.64	67.0	1.16	29.5	1
10G-12MB	7100-13325	5/8	15.8	1 1/16-12	1 1/4	—	2.78	70.5	1.30	33.0	1
12G-10MB	7100-02265	3/4	19.1	7/8-14	1	—	3.23	82.1	1.22	31.1	1
12G-12MB	7100-02335	3/4	19.0	1 1/16-12	1 1/4	—	3.33	84.5	1.32	33.5	1
12G-14MB	7100-02345	3/4	19.0	1 3/16-12	1 3/8	—	3.31	84.0	1.30	33.0	1
12G-16MB	7100-02355	3/4	19.0	1 5/16-12	1 1/2	—	3.44	87.5	1.44	36.5	1
16G-14MB	7100-02365	1	25.4	1 3/16-12	1 3/8	—	3.78	96.0	1.54	39.2	1
16G-16MB	7100-02375	1	25.4	1 5/16-12	1 1/2	—	3.72	94.5	1.48	37.7	1
16G-20MB	7100-02255	1	25.4	105/8-12	1 7/8	—	3.74	95.0	1.50	38.2	1
20G-20MB	7100-02385	1 1/4	31.8	1 5/8-12	1 7/8	—	3.82	97.0	1.50	38.0	1
BULK PACK											
4G-4MBXBULK	7100-1220	1/4	6.4	7/16-20	9/16	—	1.99	50.5	.96	24.5	175
4G-5MBXBULK	7100-1221	1/4	6.4	1/2-20	5/8	—	1.99	50.5	.96	24.5	200
4G-6MBXBULK	7100-1222	1/4	6.4	9/16-18	11/16	—	2.05	52.0	1.02	26.0	100
6G-6MBXBULK	7100-1323	3/8	9.5	9/16-18	11/16	—	2.07	52.5	.96	24.5	250
6G-8MBXBULK	7100-1324	3/8	9.5	3/4-16	7/8	—	2.17	55.0	1.07	27.1	200
6G-10MBXBULK	7100-1225	3/8	9.5	7/8-14	1	—	2.22	56.5	1.13	28.6	175
8G-8MBXBULK	7100-1327	1/2	12.7	7/8-14	7/8	—	2.54	64.5	1.06	27.0	135
8G-10MBXBULK	7100-1328	1/2	12.7	7/8-14	1	—	2.58	65.5	1.10	28.0	125
8G-12MBXBULK	7100-1329	1/2	12.7	1 1/16-12	1 1/4	—	2.78	70.5	1.30	33.0	100
10G-10MBXBULK	7100-1331	5/8	15.8	7/8-14	1	—	2.64	67.0	1.16	29.5	100
10G-12MBXBULK	7100-1332	5/8	15.8	1 1/16-12	1 1/4	—	2.78	70.5	1.30	33.0	75
12G-12MBXBULK	7100-0233	3/4	19.0	1 1/16-12	1 1/4	—	3.33	84.5	1.32	33.5	60
16G-16MBXBULK	7100-0237	1	25.4	1 5/16-12	1 1/2	—	3.72	94.5	1.48	37.7	30

Male O-Ring Boss Swivel

NOT TO BE USED AS A LIVE SWIVEL.

NOTE: Internal O-Rings rated at 250°F (121°C).

SAE J1926/3 ISO 11926-3 Light-Duty (L Series) Stud End.

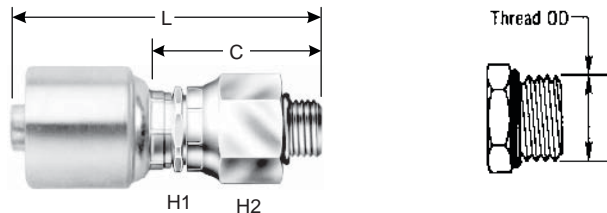

Descr.	Prod. No.	⊖			H1	H2	L		C		Std. Pack
		"	mm		"	"	"	mm	"	mm	
STANDARD PACK											
4G-4MBX	7100-12385	1/4	6.4	7/16-20	1/2	23/32	2.69	68.4	1.67	42.4	1
4G-6MBX	7100-12395	1/4	6.4	9/16-18	5/8	7/8	2.65	67.3	1.62	41.2	1
6G-6MBX	7100-12405	3/8	6.4	9/16-18	5/8	3/4	2.73	69.3	1.63	41.3	1
6G-8MBX	7100-12415	3/8	9.5	3/4-16	3/4	1	2.74	69.6	1.64	41.6	1





Male O-Ring Boss Swivel - Cont'd

Descr.	Prod. No.	⊖			H1	H2	L		C		Std. Pack
		"	mm				"	mm	"	mm	
6G-10MBX	7100-12425	3/8	9.5	7/8-14	3/4	1	2.80	71.1	1.70	43.1	1
8G-8MBX	7100-02435	1/2	12.7	3/4-16	13/16	1	3.11	79.1	1.64	41.6	1
8G-10MBX	7100-02445	1/2	12.7	7/8-14	13/16	1	3.17	80.6	1.70	43.1	1
10G-10MBX	7100-02645	5/8	15.8	7/8-14	15/16	1 3/16	3.47	88.3	2.00	50.8	1
12G-12MBX	7100-02455	3/4	19.0	1 1/16-12	1 1/16	1 5/16	4.00	101.5	1.99	50.5	1
BULK PACK											
6G-6MBX XBULK	7100-1240	3/8	6.4	9/16-18	5/8	3/4	2.73	69.3	1.63	41.3	100
6G-8MBX XBULK	7100-1241	3/8	9.5	3/4-16	3/4	1	2.74	69.6	1.64	41.6	125
8G-8MBX XBULK	7100-0243	1/2	12.7	3/4-16	13/16	1	3.11	79.1	1.64	41.6	125
8G-10MBX XBULK	7100-0244	1/2	12.7	7/8-14	13/16	1	3.17	80.6	1.70	43.1	125
12G-12MBX XBULK	7100-0245	3/4	19.0	1 1/16-12	1 1/16	1 5/16	4.00	101.5	1.99	50.5	60

Male O-Ring Boss Swivel - 45° Block

NOT TO BE USED AS A LIVE SWIVEL.

NOTE: Internal O-Rings rated at 250°F (121°C).

SAE J1926/3 ISO 11926-3 Light-Duty (L Series) Stud End.

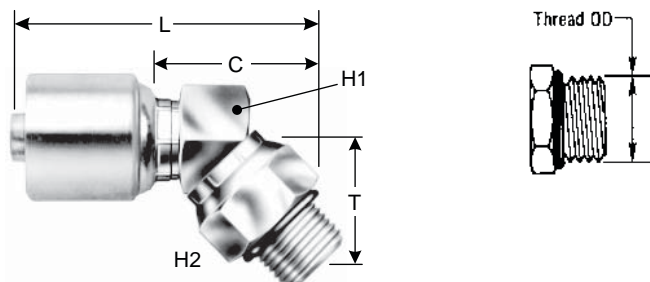

Descr.	Prod. No.	⊖			H1	H2	T		L		C		Std. Pack
		"	mm				"	mm	"	mm	"	mm	
STANDARD PACK													
6G-6MBX45	7100-12475	3/8	9.5	9/16-18	3/4	7/8	1.09	27.8	3.11	79.0	2.01	51.0	1
6G-8MBX45	7100-12485	3/8	9.5	3/4-16	3/4	1	1.06	26.9	3.07	78.1	1.98	50.2	1
8G-8MBX45	7100-02495	1/2	12.7	3/4-16	1	1	1.12	28.4	3.04	77.2	1.56	39.7	1
8G-10MBX45	7100-02505	1/2	12.7	7/8-14	1	1	1.16	29.5	3.08	78.3	1.61	40.8	1
BULK PACK													
8G-8MBX45XBULK	7100-0249	1/2	12.7	3/4-16	1	1	1.12	28.4	3.04	77.2	1.56	39.7	75

EQUIPMENT

HOSE/CPLG. SELECTION

GLOBAL SPIRAL COUPLINGS

PCM/PCS FERRULES

MEGACRIMP COUPLINGS

POWER CRIMP COUPLINGS

LOW PRESSURE COUPLINGS

POLARSEAL COUPLINGS

C14 COUPLINGS

PCTS THERMO-PLASTIC COUPLINGS

FIELD ATTACHABLE G1 & G2 COUPLINGS

FIELD ATTACHABLE C5 COUPLINGS

SURELOK AIR BRAKE COUPLINGS

QUICK DISCONNECT COUPLERS

NEW BALL VALVES

ACCESSORIES

EQUIPMENT AND PARTS





MegaCrimp® Couplings

Male O-Ring Boss Swivel - 90° Block

NOT TO BE USED AS A LIVE SWIVEL.

NOTE: Internal O-Rings rated at 250°F (121°C).

SAE J1926/3 ISO 11926-3 Light-Duty (L Series) Stud End.

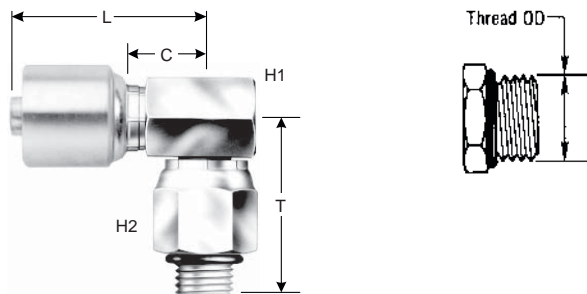

Descr.	Prod. No.	⊖		🌀	H1	H2	T		L		C		Std. Pack	
		"	mm		"	"	"	mm	"	mm	"	mm		
STANDARD PACK														
4G-5MBX90	7100-12555	1/4	6.4	1/2-20	11/16	11/16	1.57	40.0	1.82	46.3	.80	20.2	1	
POLARSEAL COUPLINGS	4G-6MBX90	7100-12515	1/4	6.4	9/16-18	11/16	7/8	1.65	41.8	1.82	46.3	.80	20.2	1
	6G-6MBX90	7100-12525	3/8	9.5	9/16-18	3/4	7/8	1.67	42.5	1.96	49.7	.85	21.7	1
C14 COUPLINGS	6G-8MBX90	7100-12535	3/8	9.5	3/4-16	3/4	1	1.63	41.3	2.41	61.2	.83	21.1	1
	6G-10MBX90	7100-12545	3/8	9.5	7/8-14	3/4	1	1.69	42.8	1.95	49.6	.85	21.7	1
	8G-8MBX90	7100-02555	1/2	12.7	3/4-16	1	1	1.75	44.5	2.55	64.7	1.07	27.2	1
PCTS THERMO-PLASTIC COUPLINGS	8G-10MBX90	7100-02565	1/2	12.7	7/8-14	1	1	1.81	46.0	2.55	64.7	1.07	27.2	1
	8G-12MBX90	7100-02575	1/2	12.7	1 1/16-12	1	1 5/16	2.09	53.1	2.52	64.1	1.05	26.6	1
	10G-10MBX90	7100-02585	5/8	15.9	7/8-14	1	1	1.81	46.0	2.40	60.9	.93	23.5	1
FIELD ATTACHABLE G1 & G2 COUPLINGS	12G-12MBX90	7100-02595	3/4	19.0	1 1/16-12	1 3/8	1 5/16	2.39	60.6	3.18	80.7	1.17	29.7	1
	BULK PACK													
FIELD ATTACHABLE C5 COUPLINGS	6G-6MBX90XBULK	7100-1252	3/8	9.5	9/16-18	3/4	7/8	1.67	42.5	1.96	49.7	.85	21.7	125
	6G-8MBX90XBULK	7100-1253	3/8	9.5	3/4-16	3/4	1	1.63	41.3	2.41	61.2	.83	21.1	125
	6G-10MBX90XBULK	7100-1254	3/8	9.5	7/8-14	3/4	1	1.69	42.8	1.95	49.6	.85	21.7	125
	8G-8MBX90XBULK	7100-0255	1/2	12.7	3/4-16	1	1	1.75	44.5	2.55	64.7	1.07	27.2	75
	8G-10MBX90XBULK	7100-0256	1/2	12.7	7/8-14	1	1	1.81	46.0	2.55	64.7	1.07	27.2	75
	12G-12MBX90XBULK	7100-0259	3/4	19.0	1 1/16-12	1 3/8	1 5/16	2.39	60.6	3.18	80.7	1.17	29.7	20





Male O-Ring Boss Swivel - 90° Long Block

NOT TO BE USED AS A LIVE SWIVEL.

NOTE: Internal O-Rings rated at 250°F (121°C).

SAE J1926/3 ISO 11926-3 Light-Duty (L Series) Stud End.

These couplings have a longer reach (L dimension) to accommodate the OmniCrimp® 21 crimper.

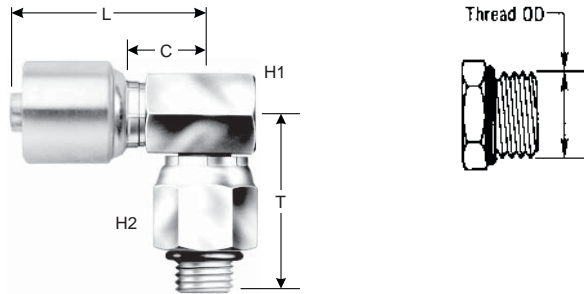

Descr.	Prod. No.	⊖			H1	H2	T		L		C		Std. Pack
		"	mm				"	mm	"	mm	"	mm	
STANDARD PACK													
8G-8MBX90L	7100-02705	1/2	12.7	3/4-16	1	1	1.75	44.4	3.27	83.1	1.80	45.6	1
8G-10MBX90L	7100-02715	1/2	12.7	7/8-14	1	1	1.81	46.0	3.27	83.1	1.80	45.6	1
8G-12MBX90L	7100-02725	1/2	12.7	1 1/16-12	1	1 5/16	2.09	53.1	3.76	95.5	2.28	58.0	1
10G-10MBX90L	7100-02735	5/8	15.8	7/8-14	1	1	1.81	46.0	3.27	83.1	1.80	45.6	1
12G-12MBX90L	7100-02755	3/4	19.0	1 1/16-12	1	1 5/16	2.28	57.9	3.94	100.0	1.93	48.9	1

Male O-Ring Boss Adapterless Swivel

NOTE: Internal O-Rings rated at 250°F (121°C).

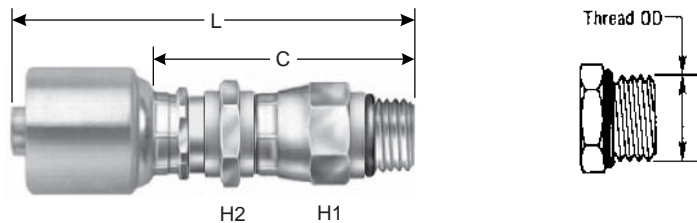

Descr.	Prod. No.	⊖			H1	H2	L		C		Std. Pack
		"	mm				mm	mm	"	mm	
STANDARD PACK											
4G-4MBAX	7100-17115	1/4	6.4	7/16-20	17.0	17.0	3.19	81.0	2.17	55.0	1
4G-6MBAX	7100-17135	1/4	6.4	9/16-18	17.0	17.0	3.19	81.0	2.17	55.0	1
6G-6MBAX	7100-17215	3/8	9.5	9/16-18	22.0	22.0	3.44	87.5	2.35	59.6	1
6G-8MBAX	7100-17225	3/8	9.5	3/4-16	17.0	22.0	3.43	87.0	2.33	59.1	1
8G-8MBAX	7100-17265	1/2	12.7	3/4-16	24.0	24.0	4.02	102.0	2.54	64.5	1
10G-10MBAX	7100-17315	5/8	15.8	7/8-14	24.0	30.0	4.25	108.0	2.78	70.5	1
12G-12MBAX	7100-17365	3/4	19.0	1 1/16-12	36.0	36.0	5.16	131.0	3.15	80.0	1

EQUIPMENT

HOSE/CPLG. SELECTION

GLOBAL SPIRAL COUPLINGS

PCM/PCS FERRULES

MEGACRIMP COUPLINGS

POWER CRIMP COUPLINGS

LOW PRESSURE COUPLINGS

POLARSEAL COUPLINGS

C14 COUPLINGS

PCTS THERMO-PLASTIC COUPLINGS

FIELD ATTACHABLE G1 & G2 COUPLINGS

FIELD ATTACHABLE C5 COUPLINGS

SURELOK AIR BRAKE COUPLINGS

QUICK DISCONNECT COUPLERS

NEW BALL VALVES

ACCESSORIES

EQUIPMENT AND PARTS





MegaCrimp® Couplings

Male O-Ring Boss Adapterless Swivel - 45° Bent Tube

NOTE: Internal O-Rings rated at 250°F (121°C).

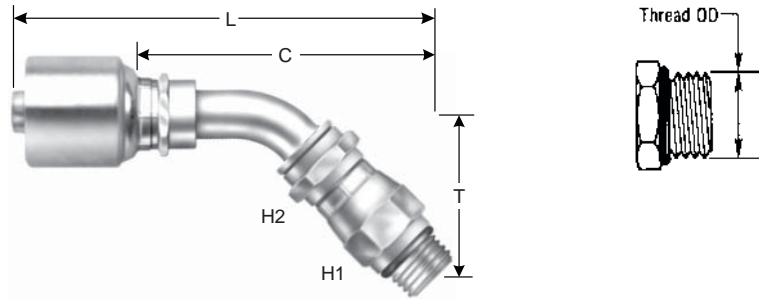

Descr.	Prod. No.	⌀		🌀	H1	H2	T		L		C		Std. Pack
		"	mm		mm	mm	"	mm	"	mm	"	mm	
STANDARD PACK													
4G-4MBAX45	7100-17615	1/4	6.4	7/16-20	17.0	17.0	1.42	36.0	3.54	90.0	2.52	64.0	1
6G-6MBAX45	7100-17715	3/8	9.5	9/16-18	22.0	22.0	1.57	40.0	3.98	101.0	2.88	73.1	1
6G-8MBAX45	7100-17725	3/8	9.5	3/4-16	22.0	22.0	1.57	40.0	3.98	101.0	2.88	73.1	1
8G-8MBAX45	7100-17765	1/2	12.7	3/4-16	24.0	24.0	1.81	46.0	4.80	122.0	3.33	84.5	1
10G-10MBAX45	7100-17815	5/8	15.8	7/8-14	30.0	30.0	1.97	50.0	5.08	129.0	3.62	92.0	1
12G-12MBAX45	7100-17865	3/4	19.0	1 1/16-12	36.0	36.0	2.20	56.0	5.98	152.0	3.98	101.0	1

Male O-Ring Boss Adapterless Swivel - 90° Bent Tube

NOTE: Internal O-Rings rated at 250°F (121°C).

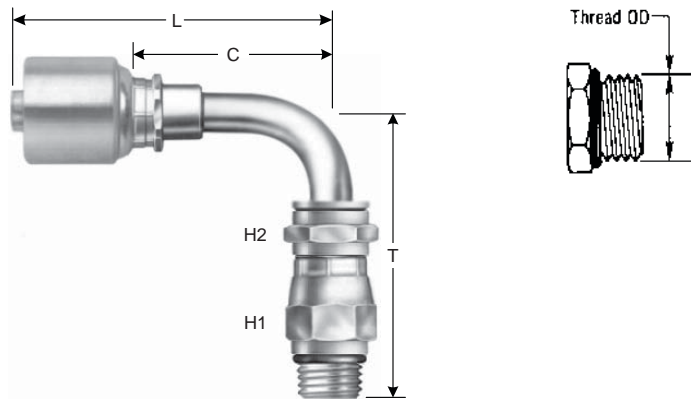

Descr.	Prod. No.	⌀		🌀	H1	H2	T		L		C		Std. Pack
		"	mm		mm	mm	"	mm	"	mm	"	mm	
STANDARD PACK													
4G-4MBAX90S	7100-18115	1/4	6.4	7/16-20	17.0	17.0	2.32	59.0	2.68	68.0	1.65	42.0	1
6G-6MBAX90S	7100-18215	3/8	9.5	9/16-18	22.0	22.0	2.60	66.0	3.07	78.0	1.97	50.1	1
6G-8MBAX90S	7100-18225	3/8	9.5	3/4-16	22.0	22.0	2.60	66.0	3.07	78.0	1.97	50.1	1
8G-8MBAX90S	7100-18265	1/2	12.7	3/4-16	24.0	24.0	3.03	77.0	3.80	96.5	2.32	59.0	1
10G-10MBAX90S	7100-18315	5/8	15.8	7/8-14	30.0	30.0	3.39	86.0	4.19	106.5	2.72	69.0	1
10G-12MBAX90S	7100-18325	5/8	15.8	1 1/16-12	36.0	36.0	3.82	97.0	4.49	114.0	3.03	77.0	1
12G-12MBAX90S	7100-18365	3/4	19.0	1 1/16-12	36.0	36.0	3.82	97.0	5.00	127.0	2.99	76.0	1





Male O-Ring Boss Adapterless Swivel - 90° Long Bent Tube

NOTE: Internal O-Rings rated at 250°F (121°C).

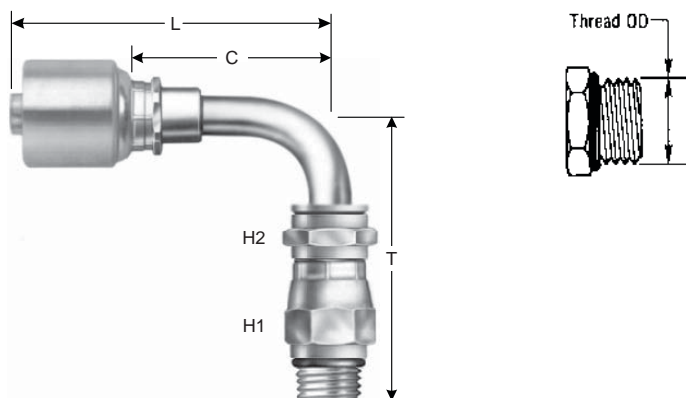

Descr.	Prod. No.	⊖			H1	H2	T		L		C		Std. Pack
		"	mm				"	mm	"	mm	"	mm	
STANDARD PACK													
4G-4MBAX90L	7100-19115	1/4	6.4	7/16-20	17.0	17.0	3.35	85.0	2.40	61.0	1.38	35.0	1
6G-6MBAX90L	7100-19215	3/8	9.5	9/16-18	22.0	22.0	3.78	96.0	2.76	70.0	1.66	42.1	1
8G-8MBAX90L	7100-19265	1/2	12.7	3/4-16	24.0	24.0	4.41	112.0	3.44	87.5	1.97	50.0	1
10G-10MBAX90L	7100-19315	5/8	15.8	7/8-14	30.0	30.0	4.96	126.0	3.76	95.5	2.28	58.0	1
12G-12MBAX90L	7100-19365	3/4	19.0	1 1/16-12	36.0	36.0	5.63	143.0	4.49	114.0	2.48	63.0	1

Male JIC 37° Flare English Hex

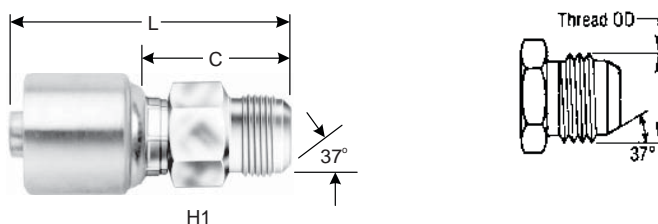

Descr.	Prod. No.	⊖			H1	H2	L		C		Std. Pack
		"	mm				"	mm	"	mm	
STANDARD PACK											
4GE-4MJ	7100-10635	1/4	6.4	9/16-18	5/8	—	2.19	55.5	1.16	29.5	5
4GE-5MJ	7100-10645	1/4	6.4	1/2-20	1/2	—	2.19	55.5	1.16	29.5	1
4GE-6MJ	7100-10825	3/8	6.4	9/16-18	9/16	—	2.20	56.0	1.18	30.0	1
5GE-5MJ	7100-10665	5/16	7.9	1/2-20	5/16	—	2.20	56.0	1.10	28.0	1
5GE-6MJ	7100-00665	5/16	7.9	9/16-18	5/8	—	2.26	57.5	1.16	29.5	1
6GE-6MJ	7100-10675	3/8	9.5	9/16-18	5/8	—	2.26	57.5	1.17	29.6	5
6GE-8MJ	7100-10835	3/8	9.5	3/4-16	3/4	—	2.40	61.0	1.30	33.1	1
6GE-10MJ	7100-10845	3/8	9.5	7/8-14	7/8	—	2.52	64.0	1.42	36.1	1
8GE-8MJ	7100-10705	1/2	12.7	3/4-16	13/16	—	2.68	68.0	1.20	30.5	1
8GE-10MJ	7100-00715	1/2	12.7	7/8-14	7/8	—	2.78	70.5	1.30	33.0	5
8GE-12MJ	7100-00725	1/2	12.7	1 1/16-12	1 1/16	—	2.97	75.5	1.50	38.0	1
10GE-8MJ	7100-00735	5/8	15.8	3/4-16	15/16	—	2.83	72.0	1.36	34.5	1
10GE-10MJ	7100-00745	5/8	15.8	7/8-14	15/16	—	2.99	76.0	1.52	38.5	1
10GE-12MJ	7100-00755	5/8	15.8	1 1/16-12	1 1/16	—	2.97	75.5	1.50	38.0	1
12GE-10MJ	7100-00825	3/4	19.0	7/8-14	1 1/16	—	3.68	93.5	1.67	42.5	1



EQUIPMENT
HOSE/CPLG. SELECTION
GLOBALSPIRAL COUPLINGS
PCM/PCS FERRULES
MEGACRIMP COUPLINGS
POWER CRIMP COUPLINGS
LOW PRESSURE COUPLINGS
POLARSEAL COUPLINGS
C14 COUPLINGS
PCTS THERMO-PLASTIC COUPLINGS
FIELD ATTACHABLE G1 & G2 COUPLINGS
FIELD ATTACHABLE C5 COUPLINGS
SURELOK AIR BRAKE COUPLINGS
QUICK DISCONNECT COUPLERS
NEW BALL VALVES
ACCESSORIES
EQUIPMENT AND PARTS

MegaCrimp® Couplings



Male JIC 37° Flare English Hex - Cont'd

DESCR.	PROD. NO.	Ø			H1	H2	L		C		STD. PACK
		"	mm		"	"	"	mm	"	mm	
12GE-12MJ	7100-00765	3/4	19.0	1 5/16-12	1 1/16	—	3.68	93.0	1.67	42.5	1
12GE-14MJ	7100-00775	3/4	19.0	1 3/16-12	1 3/16	—	3.58	91.0	1.57	40.0	1
12GE-16MJ	7100-10785	3/4	19.0	1 5/16-12	1 5/16	—	3.62	92.0	1.61	41.0	1
16GE-14MJ	7100-00835	1	25.4	1 3/16-12	1 3/8	—	4.09	104.0	1.85	47.2	1
16GE-16MJ	7100-00795	1	25.4	1 5/16-12	1 3/8	—	4.11	104.5	1.88	47.7	1
16GE-20MJ	7100-00805	1	25.4	1 5/8-12	1 3/4	—	4.29	109.0	2.06	52.2	1
20GE-20MJ	7100-00815	1 1/4	31.7	1 5/8-12	1 3/4	—	4.43	112.5	2.07	53.5	1
BULK PACK											
4GE-4MJXBULK	7100-1063	1/4	6.4	9/16-18	5/8	—	2.19	55.5	1.16	29.5	150
4GE-5MJXBULK	7100-1064	1/4	6.4	1/2-20	1/2	—	2.19	55.5	1.16	29.5	150
4GE-6MJXBULK	7100-1082	3/8	6.4	9/16-18	9/16	—	2.20	56.0	1.18	30.0	200
6GE-6MJXBULK	7100-1067	3/8	9.5	9/16-18	5/8	—	2.26	57.5	1.17	29.6	250
6GE-8MJXBULK	7100-1083	3/8	9.5	3/4-16	3/4	—	2.40	61.0	1.30	33.1	150
6GE-10MJXBULK	7100-1084	3/8	9.5	7/8-14	7/8	—	2.52	64.0	1.42	36.1	150
8GE-8MJXBULK	7100-1070	1/2	12.7	3/4-16	13/16	—	2.68	68.0	1.20	30.5	135
8GE-10MJXBULK	7100-0071	1/2	12.7	7/8-14	7/8	—	2.78	70.5	1.30	33.0	125
8GE-12MJXBULK	7100-0072	1/2	12.7	1 1/16-12	1 1/16	—	2.97	75.5	1.50	38.0	50
10GE-8MJXBULK	7100-0073	5/8	15.8	3/4-16	15/16	—	2.83	72.0	1.36	34.5	100
10GE-10MJXBULK	7100-0074	5/8	15.8	7/8-14	15/16	—	2.99	76.0	1.52	38.5	100
10GE-12MJXBULK	7100-0075	5/8	15.8	1 1/16-12	1 1/16	—	2.97	75.5	1.50	38.0	50
12GE-12MJXBULK	7100-0076	3/4	19.0	1 5/16-12	1 1/16	—	3.68	93.0	1.67	42.5	60
12GE-14MJXBULK	7100-0077	3/4	19.0	1 3/16-12	1 3/16	—	3.58	91.0	1.57	40.0	75
12GE-16MJXBULK	7100-1078	3/4	19.0	1 5/16-12	1 5/16	—	3.62	92.0	1.61	41.0	50
16GE-16MJXBULK	7100-0079	1	25.4	1 5/16-12	1 3/8	—	4.11	104.5	1.88	47.7	30
20GE-20MJXBULK	7100-0081	1 1/4	31.7	1 5/8-12	1 3/4	—	4.43	112.5	2.07	53.5	20

Male JIC 37° Flare Metric Hex

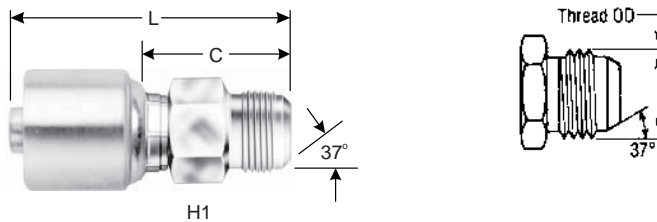

DESCR.	PROD. NO.	Ø			H1	H2	L		C		STD. PACK
		"	mm		mm	mm	"	mm	"	mm	
STANDARD PACK											
4G-4MJ	7103-36045	1/4	6.4	9/16-18	14.0	—	2.18	55.5	1.16	29.5	1
4G-5MJ	7103-36055	1/4	6.4	1/2-20	14.0	—	2.18	55.5	1.16	29.5	1
4G-6MJ	7103-36065	1/4	6.4	1/2-20	17.0	—	2.22	56.5	1.20	30.5	1
5G-5MJ	7103-36105	5/16	7.9	1/2-20	17.0	—	2.26	57.5	1.16	29.5	1
5G-6MJ	7103-36115	5/16	7.9	9/16-18	17.0	—	2.26	57.5	1.16	29.5	1
6G-6MJ	7103-36155	3/8	9.5	9/16-18	17.0	—	2.30	58.5	1.20	30.6	1
6G-8MJ	7103-36165	3/8	9.5	3/4-16	19.0	—	2.48	63.0	1.38	35.1	1
6G-10MJ	7103-36175	3/8	9.5	7/8-14	24.0	—	2.63	67.0	1.53	39.1	1
8G-8MJ	7103-36215	1/2	12.7	3/4-16	22.0	—	2.81	71.5	1.33	34.0	1
8G-10MJ	7103-36225	1/2	12.7	7/8-14	24.0	—	2.91	74.0	1.43	36.5	1
8G-12MJ	7103-36235	1/2	12.7	1 1/16-12	27.0	—	3.18	81.0	1.71	43.5	1
10G-8MJ	7103-36265	5/8	15.9	3/4-16	24.0	—	2.93	74.5	1.45	37.0	1



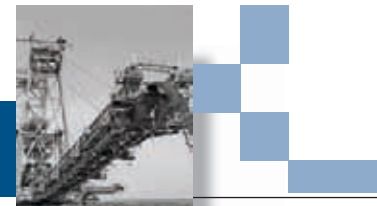



Male JIC 37° Flare Metric Hex - Cont'd

Descr.	Prod. No.	⊖			H1	H2	L		C		Std. Pack
		"	mm				"	mm	"	mm	
10G-10MJ	7103-36275	5/8	15.9	7/8-14	24.0	—	3.03	77.0	1.55	39.5	1
10G-12MJ	7103-36285	5/8	15.9	1 1/6-12	27.0	—	3.18	81.0	1.71	43.5	1
12G-10MJ	7103-36315	3/4	19.1	7/8-14	27.0	—	3.68	93.5	1.67	42.5	1
12G-12MJ	7103-36325	3/4	19.1	1 5/16-12	27.0	—	3.72	94.5	1.71	43.5	1
12G-14MJ	7103-36335	3/4	19.1	1 3/16-12	32.0	—	3.75	95.5	1.75	44.5	1
12G-16MJ	7103-36345	3/4	19.1	1 5/16-12	36.0	—	3.77	96.0	1.77	45.0	1
16G-14MJ	7103-36375	1	25.4	1 3/16-12	36.0	—	4.09	104.0	1.85	47.2	1
16G-16MJ	7103-36385	1	25.4	1 5/16-12	36.0	—	4.11	104.5	1.87	47.7	1
16G-20MJ	7103-36395	1	25.4	1 5/8-12	46.0	—	4.29	109.0	2.05	52.2	1
20G-20MJ	7103-36435	1 1/4	31.8	1 5/8-12	46.0	—	4.42	112.5	2.10	53.5	1
20G-24MJ	7103-36445	1 1/4	31.8	1 7/8-12	50.0	—	4.42	112.5	2.10	53.5	1
BULK PACK											
4G-4MJXBULK	7103-3604	1/4	6.4	9/16-18	14.0	—	2.18	55.5	1.16	29.5	150
4G-5MJXBULK	7103-3605	1/4	6.4	1/2-20	14.0	—	2.18	55.5	1.16	29.5	99
4G-6MJXBULK	7103-3606	1/4	6.4	1/2-20	17.0	—	2.22	56.5	1.20	30.5	250
6G-6MJXBULK	7103-3615	3/8	9.5	9/16-18	17.0	—	2.30	58.5	1.20	30.6	200
6G-8MJXBULK	7103-3616	3/8	9.5	3/4-16	19.0	—	2.48	63.0	1.38	35.1	150
6G-10MJXBULK	7103-3617	3/8	9.5	7/8-14	24.0	—	2.63	67.0	1.53	39.1	99
8G-8MJXBULK	7103-3621	1/2	12.7	3/4-16	22.0	—	2.81	71.5	1.33	34.0	125
8G-10MJXBULK	7103-3622	1/2	12.7	7/8-14	24.0	—	2.91	74.0	1.43	36.5	125
8G-12MJXBULK	7103-3623	1/2	12.7	1 1/16-12	27.0	—	3.18	81.0	1.71	43.5	75
10G-8MJXBULK	7103-3626	5/8	15.9	3/4-16	24.0	—	2.93	74.5	1.45	37.0	100
10G-10MJXBULK	7103-3627	5/8	15.9	7/8-14	24.0	—	3.03	77.0	1.55	39.5	100
10G-12MJXBULK	7103-3628	5/8	15.9	1 1/16-12	27.0	—	3.18	81.0	1.71	43.5	99
12G-12MJXBULK	7103-3632	3/4	19.1	1 5/16-12	27.0	—	3.72	94.5	1.71	43.5	50
12G-14MJXBULK	7103-3633	3/4	19.1	1 3/16-12	32.0	—	3.75	95.5	1.75	44.5	50
12G-16MJXBULK	7103-3634	3/4	19.1	1 5/16-12	36.0	—	3.77	96.0	1.77	45.0	50
16G-16MJXBULK	7103-3638	1	25.4	1 5/16-12	36.0	—	4.11	104.5	1.87	47.7	30
20G-20MJXBULK	7103-3643	1 1/4	31.8	1 5/8-12	46.0	—	4.42	112.5	2.10	53.5	20

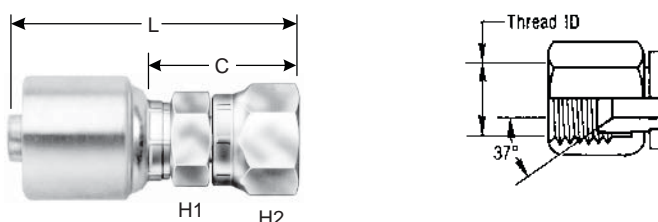
Female JIC 37° Flare Swivel English Hex



Descr.	Prod. No.	⊖			H1	H2	L		C		Std. Pack
		"	mm				"	mm	"	mm	
STANDARD PACK											
4GE-4FJX	7100-00875	1/4	6.4	7/16-20	1/2	9/16	2.10	53.4	1.08	27.4	5
4GE-5FJX	7100-10895	1/4	6.4	1/2-20	1/2	11/16	2.21	56.2	1.19	30.2	5
4GE-6FJX	7100-10905	1/4	6.4	9/16-18	9/16	3/4	2.22	56.3	1.19	30.2	5
5GE-5FJX	7100-00935	5/16	7.9	1/2-20	5/8	11/16	2.23	56.7	1.13	28.7	1
5GE-6FJX	7100-00925	5/16	7.9	9/16-18	5/8	3/4	2.31	58.8	1.21	30.8	1
6GE-4FJX	7100-10925	1/2	9.5	7/16-20	5/8	9/16	2.30	58.4	1.20	30.5	1
6GE-5FJX	7100-10935	3/8	9.5	1/2-20	5/8	11/16	2.23	56.7	1.13	28.8	1
6GE-6FJX	7100-10945	3/8	9.5	9/16-18	5/8	3/4	2.31	58.8	1.19	30.2	5



EQUIPMENT
HOSE/CPLG. SELECTION
GLOBAL SPIRAL COUPLINGS
PCM/PCS FERRULES
MEGACRIMP COUPLINGS
POWER CRIMP COUPLINGS
LOW PRESSURE COUPLINGS
POLAR SEAL COUPLINGS
C14 COUPLINGS
PCTS THERMO-PLASTIC COUPLINGS
FIELD ATTACHABLE G1 & G2 COUPLINGS
FIELD ATTACHABLE C5 COUPLINGS
SURELOK AIR BRAKE COUPLINGS
QUICK DISCONNECT COUPLERS
NEW BALL VALVES
ACCESSORIES
EQUIPMENT AND PARTS





MegaCrimp® Couplings

Female JIC 37° Flare Swivel English Hex - Cont'd

EQUIPMENT	HOSE/CPLG. SELECTION	DESCR.	PROD. NO.	Ø				H1	H2	L		C		Std. Pack
				"	mm					"	mm	"	mm	
GLOBAL SPIRAL COUPLINGS	6GE-8FJX	7100-10955	3/8	9.5	3/4-16	11/16	7/8	2.48	63.1	1.38	35.1	5		
	6GE-10FJX	7100-10965	3/8	9.5	7/8-14	13/16	1 1/16	2.61	66.2	1.50	38.2	1		
PCM/PCS FERRULES	6GE-12FJX	7100-10975	3/8	9.5	1 1/16-12	1 1/16	1 1/4	2.81	71.5	1.71	43.5	1		
	8GE-6FJX	7100-00975	1/2	12.7	9/16-18	13/16	3/4	2.63	66.8	1.15	29.3	1		
MEGACRIMP COUPLINGS	8GE-8FJX	7100-00985	1/2	12.7	3/4-16	13/16	7/8	2.82	71.6	1.34	34.1	5		
	8GE-10FJX	7100-00995	1/2	12.7	7/8-14	13/16	1 1/16	2.96	75.1	1.48	37.7	5		
POWER CRIMP COUPLINGS	8GE-12FJX	7100-01005	1/2	19.0	1 1/16-12	1	1 1/4	3.11	79.0	1.63	41.5	5		
	8GE-16FJX	7100-10985	1/2	12.7	1 5/16-12	1/2	1/16	2.47	62.8	1.44	36.8	1		
LOW PRESSURE COUPLINGS	10GE-8FJX	7100-01015	5/8	15.8	3/4-16	15/16	7/8	2.90	73.6	1.42	36.1	1		
	10GE-10FJX	7100-01025	5/8	15.8	7/8-14	15/16	1 1/16	3.04	77.1	1.56	39.7	5		
POLARSEAL COUPLINGS	10GE-12FJX	7100-01035	5/8	15.8	1 1/16-12	1	1 1/4	3.09	78.5	1.61	41.0	1		
	10GE-14FJX	7100-01045	5/8	15.8	1 3/16-12	1 1/8	1 3/8	3.14	79.7	1.66	42.2	1		
C14 COUPLINGS	12GE-10FJX	7100-01055	3/4	19.0	7/8-14	1 1/16	1 1/16	3.51	89.1	1.50	38.1	1		
	12GE-12FJX	7100-01065	3/4	19.0	1 1/16-12	1 1/16	1 1/4	3.68	93.5	1.67	42.5	5		
PCTS THERMO-PLASTIC COUPLINGS	12GE-14FJX	7100-01075	3/4	19.0	1 3/16-12	1 1/8	1 3/8	3.65	92.7	1.64	41.6	1		
	12GE-16FJX	7100-01085	3/4	19.0	1 5/16-12	1 1/4	1 1/2	3.78	96.0	1.77	45.0	1		
FIELD ATTACHABLE G1 & G2 COUPLINGS	16GE-12FJX	7100-01105	1	25.4	1 1/16-12	1 3/8	1 1/4	3.98	101.0	1.74	44.2	1		
	16GE-14FJX	7100-01115	1	25.4	1 3/16-12	1 3/8	1 3/8	4.00	101.6	1.77	44.9	1		
FIELD ATTACHABLE C5 COUPLINGS	16GE-16FJX	7100-01125	1	25.4	1 5/16-12	1 3/8	1 1/2	4.17	106.0	1.94	49.2	1		
	16GE-20FJX	7100-01135	1	25.4	1 5/8-12	1 9/16	2	4.33	109.9	2.09	53.1	1		
SURELOK AIR BRAKE COUPLINGS	20GE-20FJX	7100-01145	1 1/4	31.7	1 5/8-12	1 3/4	2	4.60	116.9	2.28	57.9	1		
	20GE-24FJX	7100-01155	1 1/4	31.7	1 7/8-12	1 7/8	2 1/4	4.85	123.2	2.53	64.2	1		
BULK PACK														
QUICK DISCONNECT COUPLERS	4GE-4FJX XBULK	7100-0087	1/4	6.4	7/16-20	1/2	9/16	2.10	53.4	1.08	27.4	325		
	4GE-5FJX XBULK	7100-1089	1/4	6.4	1/2-20	1/2	11/16	2.21	56.2	1.19	30.2	300		
NEW BALL VALVES	4GE-6FJX XBULK	7100-1090	1/4	6.4	9/16-18	9/16	3/4	2.22	56.3	1.19	30.2	300		
	5GE-6FJX XBULK	7100-0092	5/16	7.9	9/16-18	5/8	3/4	2.31	58.8	1.21	30.8	150		
ACCESSORIES	6GE-4FJX XBULK	7100-1092	1/2	9.5	7/16-20	5/8	9/16	2.30	58.4	1.20	30.5	130		
	6GE-5FJX XBULK	7100-1093	3/8	9.5	1/2-20	5/8	11/16	2.23	56.7	1.13	28.8	100		
EQUIPMENT AND PARTS	6GE-6FJX XBULK	7100-1094	3/8	9.5	9/16-18	5/8	3/4	2.31	58.8	1.19	30.2	250		
	6GE-8FJX XBULK	7100-1095	3/8	9.5	3/4-16	11/16	7/8	2.48	63.1	1.38	35.1	200		
EQUIPMENT AND PARTS	6GE-10FJX XBULK	7100-1096	3/8	9.5	7/8-14	13/16	1 1/16	2.61	66.2	1.50	38.2	150		
	8GE-6FJX XBULK	7100-0097	1/2	12.7	9/16-18	13/16	3/4	2.63	66.8	1.15	29.3	125		
EQUIPMENT AND PARTS	8GE-8FJX XBULK	7100-0098	1/2	12.7	3/4-16	13/16	7/8	2.82	71.6	1.34	34.1	150		
	8GE-10FJX XBULK	7100-0099	1/2	12.7	7/8-14	13/16	1 1/16	2.96	75.1	1.48	37.7	125		
EQUIPMENT AND PARTS	8GE-12FJX XBULK	7100-0100	1/2	19.0	1 1/16-12	1	1 1/4	3.11	79.0	1.63	41.5	100		
	10GE-8FJX XBULK	7100-0101	5/8	15.8	3/4-16	15/16	7/8	2.90	73.6	1.42	36.1	110		
EQUIPMENT AND PARTS	10GE-10FJX XBULK	7100-0102	5/8	15.8	7/8-14	15/16	1 1/16	3.04	77.1	1.56	39.7	100		
	10GE-12FJX XBULK	7100-0103	5/8	15.8	1 1/16-12	1	1 1/4	3.09	78.5	1.61	41.0	100		
EQUIPMENT AND PARTS	12GE-10FJX XBULK	7100-0105	3/4	19.0	7/8-14	1 1/16	1 1/16	3.51	89.1	1.50	38.1	50		
	12GE-12FJX XBULK	7100-0106	3/4	19.0	1 1/16-12	1 1/16	1 1/4	3.68	93.5	1.67	42.5	65		
EQUIPMENT AND PARTS	12GE-14FJX XBULK	7100-0107	3/4	19.0	1 3/16-12	1 1/8	1 3/8	3.65	92.7	1.64	41.6	50		
	12GE-16FJX XBULK	7100-0108	3/4	19.0	1 5/16-12	1 1/4	1 1/2	3.78	96.0	1.77	45.0	50		
EQUIPMENT AND PARTS	16GE-12FJX XBULK	7100-0110	1	25.4	1 1/16-12	1 3/8	1 1/4	3.98	101.0	1.74	44.2	25		
	16GE-14FJX XBULK	7100-0111	1	25.4	1 3/16-12	1 3/8	1 3/8	4.00	101.6	1.77	44.9	25		
EQUIPMENT AND PARTS	16GE-16FJX XBULK	7100-0112	1	25.4	1 5/16-12	1 3/8	1 1/2	4.17	106.0	1.94	49.2	35		
	16GE-20FJX XBULK	7100-0113	1	25.4	1 5/8-12	1 9/16	2	4.33	109.9	2.09	53.1	30		
EQUIPMENT AND PARTS	20GE-20FJX XBULK	7100-0114	1 1/4	31.7	1 5/8-12	1 3/4	2	4.60	116.9	2.28	57.9	20		





Female JIC 37° Flare Swivel - 30° Bent Tube English Hex

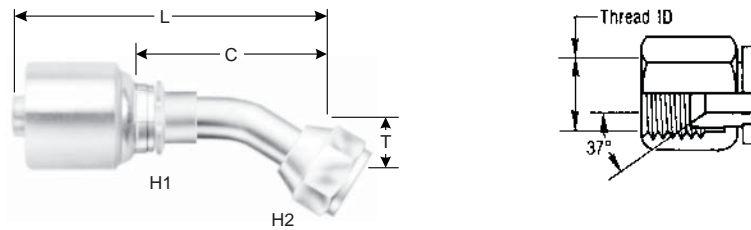

Descr.	Prod. No.	⊖			H1	H2	T		L		C		Std. Pack
		"	mm				"	mm	"	mm	"	mm	
STANDARD PACK													
10GE-12FJX30-018	7100-01185	5/8	15.8	1 1/16-12	1 1/4	7/8	.70	17.8	4.45	112.4	2.95	74.9	1
12GE-10FJX30	7100-07125	3/4	19.0	7/8-14	1	1 1/16	.70	17.8	4.45	113.0	2.44	62.0	1

Female JIC 37° Flare Swivel - 45° Bent Tube English Hex

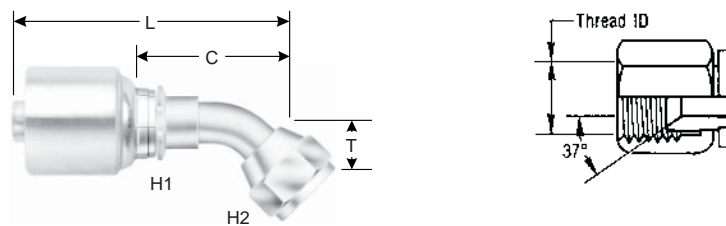

Descr.	Prod. No.	⊖			H1	H2	T		L		C		Std. Pack
		"	mm				"	mm	"	mm	"	mm	
STANDARD PACK													
4GE-4FJX45	7100-11215	1/4	6.4	7/16-20	1/2	9/16	.47	11.9	2.28	58.0	1.26	32.0	1
4GE-5FJX45	7100-11235	1/4	6.4	1/2-20	1/2	5/8	.56	14.2	2.56	65.0	1.54	39.0	1
4GE-6FJX45	7100-11255	1/4	6.4	9/16-18	1/2	11/16	.56	14.2	2.73	69.4	1.71	43.4	1
5GE-5FJX45	7100-01265	5/16	7.9	1/2-20	5/8	5/8	.56	14.2	2.60	66.0	1.50	38.0	1
5GE-6FJX45	7100-01275	5/16	7.9	9/16-18	5/8	11/16	.56	14.2	2.87	73.0	1.77	45.0	1
6GE-4FJX45	7100-11285	3/8	9.5	7/16-20	5/8	11/16	.56	14.2	2.89	73.4	1.79	45.4	1
6GE-6FJX45	7100-11305	3/8	9.5	9/16-18	5/8	11/16	.56	14.2	2.91	73.9	1.81	46.0	1
6GE-8FJX45	7100-11325	3/8	9.5	3/4-16	5/8	7/8	.69	17.5	2.88	73.1	1.78	45.2	1
8GE-8FJX45S-015	7100-20005	1/2	12.7	3/4-16	13/16	7/8	.59	15.0	3.31	84.1	1.83	46.6	1
8GE-10FJX45	7100-01365	1/2	12.7	1-14	13/16	1	.75	19.1	3.62	91.9	2.14	54.4	1
10GE-10FJX45	7100-01375	5/8	15.9	7/8-14	15/16	1	.75	19.1	3.60	91.5	2.13	54.0	1
10GE-12FJX45	7100-01385	5/8	15.9	1 1/16-12	15/16	1 1/4	1.06	26.9	4.13	105.0	2.66	67.5	1
12GE-10FJX45	7100-01395	3/4	19.0	7/8-14	1 1/16	1	.75	19.1	4.57	116.0	2.56	65.0	1
12GE-12FJX45	7100-01415	3/4	19.0	1 1/16-12	1 1/16	1 1/4	1.06	26.9	4.89	124.2	2.88	73.2	1
12GE-16FJX45	7100-01425	3/4	19.0	1 5/16-12	1 3/16	1 1/2	1.16	29.5	5.75	146.0	3.74	95.0	1
16GE-12FJX45S	7100-01435	1	25.4	1 5/16-1/2	1 3/8	1 1/4	.82	21.0	5.15	131.0	2.92	74.2	1
16GE-16FJX45	7100-01455	1	25.4	1 5/16-12	1 3/8	1 1/2	1.16	29.5	5.30	134.6	3.06	77.8	1
20GE-20FJX45	7100-01465	1 1/4	31.7	1 5/8-12	1 3/4	2	1.38	35.0	6.65	169.0	4.33	110.0	1
BULK PACK													
4GE-4FJX45XBULK	7100-1121	1/4	6.4	7/16-20	1/2	9/16	.47	11.9	2.28	58.0	1.26	32.0	300
4GE-6FJX45XBULK	7100-1125	1/4	6.4	9/16-18	1/2	11/16	.56	14.2	2.73	69.4	1.71	43.4	265
6GE-6FJX45XBULK	7100-1130	3/8	9.5	9/16-18	5/8	11/16	.56	14.2	2.91	73.9	1.81	46.0	200
6GE-8FJX45XBULK	7100-1132	3/8	9.5	3/4-16	5/8	7/8	.69	17.5	2.88	73.1	1.78	45.2	100
8GE-8FJX45SXBULK	7100-2000	1/2	12.7	3/4-16	13/16	7/8	.59	15.0	3.31	84.1	1.83	46.6	125

EQUIPMENT

HOSE/CPLG. SELECTION

GLOBALSPIRAL COUPLINGS

PCM/PCS FERRULES

MEGACRIMP COUPLINGS

POWER CRIMP COUPLINGS

LOW PRESSURE COUPLINGS

POLARSEAL COUPLINGS

C14 COUPLINGS

PCTS THERMO-PLASTIC COUPLINGS

FIELD ATTACHABLE G1 & G2 COUPLINGS

FIELD ATTACHABLE C5 COUPLINGS

SURELOK AIR BRAKE COUPLINGS

QUICK DISCONNECT COUPLERS

NEW BALL VALVES

ACCESSORIES

EQUIPMENT AND PARTS





MegaCrimp® Couplings

Female JIC 37° Flare Swivel - 45° Bent Tube English Hex - Cont'd

Descr.	Prod. No.	⊖			H1	H2	T		L		C		Std. Pack
		"	mm				"	mm	"	mm	"	mm	
8GE-10FJX45XBULK	7100-0136	1/2	12.7	1-14	13/16	1	.75	19.1	3.62	91.9	2.14	54.4	100
10GE-10FJX45XBULK	7100-0137	5/8	15.9	7/8-14	15/16	1	.75	19.1	3.60	91.5	2.13	54.0	100
10GE-12FJX45XBULK	7100-0138	5/8	15.9	1 1/16-12	15/16	1 1/4	1.06	26.9	4.13	105.0	2.66	67.5	50
12GE-12FJX45XBULK	7100-0141	3/4	19.0	1 1/16-12	1 5/16	1 1/4	1.06	26.9	4.89	124.2	2.89	73.2	50
16GE-16FJX45XBULK	7100-0145	1	25.4	1 5/16-12	1 3/8	1 1/2	1.16	29.5	5.30	134.6	3.06	77.8	25

Female JIC 37° Flare Swivel - 90° Short Bent Tube English Hex

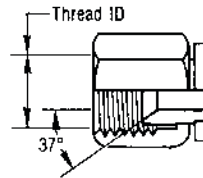
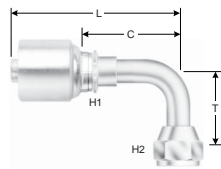



Descr.	Prod. No.	⊖			H1	H2	T		L		C		Std. Pack
		"	mm				"	mm	"	mm	"	mm	
STANDARD PACK													
4GE-4FJX90S	7100-11475	1/4	6.4	7/16-20	1/2	9/16	.68	17.3	2.26	57.3	1.23	31.3	1
4GE-5FJX90S	7100-11505	1/4	6.4	1/2-20	1/2	5/8	.77	19.6	2.32	59.0	1.30	33.0	1
4GE-6FJX90S	7100-11535	1/4	6.4	9/16-18	1/2	11/16	.85	21.6	2.52	63.9	1.49	37.9	1
5GE-6FJX90S	7100-07235	5/8	7.9	9/16-18	5/8	11/16	.85	21.6	2.67	67.9	1.57	39.9	1
6GE-4FJX90S	7100-07305	3/8	9.5	7/16-20	5/8	9/16	.83	21.0	2.37	60.3	1.28	32.4	1
6GE-6FJX90S	7100-11565	3/8	9.5	9/16-18	5/8	11/16	.85	21.6	2.36	60.0	1.22	31.0	1
6GE-8FJX90S	7100-11595	3/8	9.5	3/4-16	5/8	7/8	1.09	27.7	2.74	69.7	1.65	41.8	1
8GE-8FJX90S	7100-20015	1/2	12.7	3/4-16	13/16	7/8	1.14	29.0	3.16	80.3	1.69	42.8	1
8GE-10FJX90S	7100-01655	1/2	12.7	7/8-14	13/16	1	1.23	31.2	3.72	94.5	2.24	57.0	1
8GE-12FJX90S	7100-11645	1/2	12.7	1 1/16-12	13/16	1 1/4	1.89	48.0	4.13	105.0	2.66	67.5	1
10GE-10FJX90S	7100-01685	5/8	15.8	7/8-14	15/16	1	1.23	31.2	3.37	85.5	1.89	48.0	1
10GE-12FJX90S	7100-01695	5/8	15.8	1 1/16-12	15/16	1 1/4	1.82	46.2	3.77	95.8	2.30	58.3	1
12GE-12FJX90S	7100-01715	3/4	19.0	1 1/16-12	1 1/16	1 1/4	1.82	46.2	4.26	108.2	2.25	57.2	1
12GE-14FJX90S	7100-01745	3/4	19.0	1 3/16-12	1 1/16	34.93	2.00	50.8	4.88	124.0	2.87	73.0	1
12GE-16FJX90S	7100-01815	3/4	19.0	1 5/16-12	1 1/16	1 1/2	2.20	56.0	4.60	117.0	2.60	66.0	1
16GE-16FJX90S	7100-01765	1	25.4	1 5/16-12	1 3/8	1 1/2	2.23	56.6	5.11	129.9	2.88	73.1	1
16GE-20FJX90S	7100-07205	1	25.4	1 5/8-12	1 3/8	2	2.95	75.0	6.57	167.0	4.34	110.2	1
BULK PACK													
4GE-4FJX90SXBULK	7100-1147	1/4	6.4	7/16-20	1/2	9/16	.68	17.3	2.26	57.3	1.23	31.3	300
4GE-5FJX90SXBULK	7100-1150	1/4	6.4	1/2-20	1/2	5/8	.77	19.6	2.32	59.0	1.30	33.0	125
4GE-6FJX90SXBULK	7100-1153	1/4	6.4	9/16-18	1/2	11/16	.85	21.6	2.52	63.9	1.49	37.9	260
6GE-6FJX90SXBULK	7100-1156	3/8	9.5	9/16-18	5/8	11/16	.85	21.6	2.36	60.0	1.22	31.0	200
6GE-8FJX90SXBULK	7100-1159	3/8	9.5	3/4-16	5/8	7/8	1.09	27.7	2.74	69.7	1.65	41.8	25
8GE-8FJX90SXBULK	7100-2001	1/2	12.7	3/4-16	13/16	7/8	1.14	29.0	3.16	80.3	1.69	42.8	100
8GE-10FJX90SXBULK	7100-0165	1/2	12.7	7/8-14	13/16	1	1.23	31.2	3.72	94.5	2.24	57.0	75
10GE-10FJX90SXBULK	7100-0168	5/8	15.8	7/8-14	15/16	1	1.23	31.2	3.37	85.5	1.89	48.0	80
10GE-12FJX90SXBULK	7100-0169	5/8	15.8	1 1/16-12	15/16	1 1/4	1.82	46.2	3.77	95.8	2.30	58.3	25
12GE-12FJX90SXBULK	7100-0171	3/4	19.0	1 1/16-12	1 1/16	1 1/4	1.82	46.2	4.26	108.2	2.25	57.2	45
12GE-14FJX90SXBULK	7100-0174	3/4	19.0	1 3/16-12	1 1/16	34.93	2.00	50.8	4.88	124.0	2.87	73.0	40
12GE-16FJX90SXBULK	7100-0181	3/4	19.0	1 5/16-12	1 1/16	1 1/2	2.20	56.0	4.60	117.0	2.60	66.0	40
16GE-16FJX90SXBULK	7100-0176	1	25.4	1 5/16-12	1 3/8	1 1/2	2.23	56.6	5.11	129.9	2.88	73.1	25



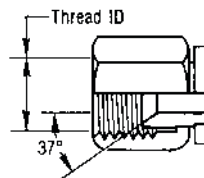
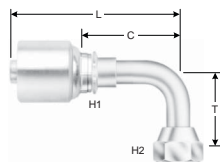

Female JIC 37° Flare Swivel - 90° Medium Bent Tube English Hex



Descr.	Prod. No.	⊖			H1	H2	T		L		C		Std. Pack
		"	mm				"	mm	"	mm	"	mm	
STANDARD PACK													
4GE-4FJX90M	7100-11485	1/4	6.4	7/16-20	1/2	9/16	.88	22.4	2.06	52.2	1.03	26.2	1
4GE-5FJX90M	7100-11515	1/4	6.4	1/2-20	1/2	5/8	1.13	28.7	2.17	55.2	1.15	29.2	1
4GE-6FJX90M	7100-07165	1/4	6.4	9/16-18	1/2	11/16	1.13	28.7	2.52	64.0	1.50	38.0	1
5GE-6FJX90M	7100-01555	5/16	7.9	9/16-18	5/8	11/16	1.13	28.7	2.52	64.0	1.42	36.0	1
6GE-6FJX90M	7100-11575	3/8	9.5	9/16-18	5/8	11/16	1.13	28.7	2.32	58.9	1.22	31.0	5
6GE-8FJX90M	7100-11605	3/8	9.5	3/4-16	5/8	7/8	1.38	35.1	2.54	64.4	1.44	36.5	1
6GE-10FJX90M	7100-07215	3/8	9.5	7/8-14	5/8	1	1.75	44.5	2.78	70.5	1.67	42.5	1
8GE-8FJX90M	7100-20045	1/2	12.7	3/4-16	13/16	7/8	1.38	35.0	2.91	74.0	1.44	36.6	1
8GE-10FJX90M	7100-01665	1/2	12.7	7/8-14	13/16	1	1.75	44.5	3.20	81.3	1.73	43.9	1
10GE-10FJX90M	7100-01705	5/8	15.8	7/8-14	15/16	1	1.75	44.5	3.19	81.0	1.71	43.5	1
10GE-12FJX90M	7100-07145	5/8	15.8	1 3/16-12	15/16	1 1/4	2.06	52.3	3.35	85.0	1.87	47.5	1
12GE-10FJX90M	7100-07195	3/4	19.0	7/8-14	1 1/16	1	1.75	44.5	3.78	96.0	1.77	45.0	1
12GE-12FJX90M	7100-01725	3/4	19.0	1 1/16-12	1 1/16	1 1/4	2.06	52.3	3.83	97.2	1.82	46.2	1
16GE-16FJX90M	7100-02075	1	25.4	1 5/16-12	1 3/8	1 1/2	2.62	66.5	4.52	114.9	2.29	58.1	1
20GE-20FJX90M	7100-01795	1 1/4	31.7	1 5/8-12	1 3/4	2	3.50	88.9	5.43	138.0	3.11	79.0	1
BULK PACK													
4GE-4FJX90MXBULK	7100-1148	1/4	6.4	7/16-20	1/2	9/16	.88	22.4	2.06	52.2	1.03	26.2	275
4GE-5FJX90MXBULK	7100-1151	1/4	6.4	1/2-20	1/2	5/8	1.13	28.7	2.17	55.2	1.15	29.2	100
4GE-6FJX90MXBULK	7100-0716	1/4	6.4	9/16-18	1/2	11/16	1.13	28.7	2.52	64.0	1.50	38.0	250
6GE-6FJX90MXBULK	7100-1157	3/8	9.5	9/16-18	5/8	11/16	1.13	28.7	2.32	58.9	1.22	31.0	200
6GE-8FJX90MXBULK	7100-1160	3/8	9.5	3/4-16	5/8	7/8	1.38	35.1	2.54	64.4	1.44	36.5	25
8GE-8FJX90MXBULK	7100-2004	1/2	12.7	3/4-16	13/16	7/8	1.38	35.0	2.91	74.0	1.44	36.6	100
8GE-10FJX90MXBULK	7100-0166	1/2	12.7	7/8-14	13/16	1	1.75	44.5	3.20	81.3	1.73	43.9	90
10GE-10FJX90MXBULK	7100-0170	5/8	15.8	7/8-14	15/16	1	1.75	44.5	3.19	81.0	1.71	43.5	80
12GE-12FJX90MXBULK	7100-0172	3/4	19.0	1 1/16-12	1 1/16	1 1/4	2.06	52.3	3.83	97.2	1.82	46.2	40
16GE-16FJX90MXBULK	7100-0207	1	25.4	1 5/16-12	1 3/8	1 1/2	2.62	66.5	4.52	114.9	2.29	58.1	25
20GE-20FJX90MXBULK	7100-0179	1 1/4	31.7	1 5/8-12	1 3/4	2	3.50	88.9	5.43	138.0	3.11	79.0	15

EQUIPMENT

HOSE/CPLG. SELECTION

GLOBAL SPIRAL COUPLINGS

PCM/PCS FERRULES

MEGACRIMP COUPLINGS

POWER CRIMP COUPLINGS

LOW PRESSURE COUPLINGS

POLARSEAL COUPLINGS

C14 COUPLINGS

PCTS THERMO-PLASTIC COUPLINGS

FIELD ATTACHABLE G1 & G2 COUPLINGS

FIELD ATTACHABLE C5 COUPLINGS

SURELOK AIR BRAKE COUPLINGS

QUICK DISCONNECT COUPLERS

NEW BALL VALVES

ACCESSORIES

EQUIPMENT AND PARTS



MegaCrimp® Couplings

Female JIC 37° Flare Swivel - 90° Long Bent Tube English Hex

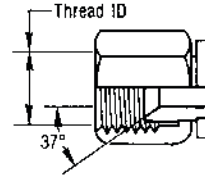
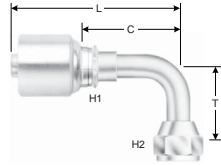

Descr.	Prod. No.	⊖		🌀	H1	H2	T		L		C		Std. Pack
		"	mm		"	"	"	mm	"	mm	"	mm	
STANDARD PACK													
4GE-4FJX90L	7100-11495	1/4	6.4	7/16-20	1/2	9/16	1.80	45.7	2.06	52.2	1.03	26.2	1
4GE-5FJX90L	7100-11525	1/4	6.4	1/2-20	1/2	5/8	1.79	45.7	2.17	55.2	1.15	29.2	1
4GE-6FJX90L	7100-11555	1/4	6.4	9/16-18	1/2	11/16	2.13	54.0	2.80	71.0	1.77	45.0	1
6GE-4FJX90L	7100-07325	3/8	9.5	7/16-20	5/8	9/16	1.81	46.0	2.21	56.2	1.11	28.3	1
6GE-6FJX90L	7100-11585	3/8	9.5	9/16-18	5/8	11/16	2.18	55.4	2.60	66.0	1.50	38.1	1
6GE-8FJX90L	7100-11615	3/8	9.5	3/4-16	5/8	7/8	2.43	61.7	2.54	64.4	1.44	36.5	1
8GE-8FJX90L	7100-20035	1/2	12.7	3/4	13/16	7/8	2.52	64.0	2.91	74.0	1.44	36.6	1
8GE-10FJX90L	7100-01675	1/2	12.7	7/8-14	1	1	2.57	65.3	3.15	80.1	1.68	42.7	1
10GE-10FJX90L	7100-07175	5/8	15.8	7/8-14	15/16	1	2.57	65.3	3.19	81.0	1.71	43.5	1
10GE-12FJX90L	7100-07245	5/8	15.8	1 1/16-12	15/16	1 1/4	3.78	96.0	3.35	85.0	1.87	47.5	1
12GE-12FJX90L	7100-01735	3/4	19.0	1 1/16-12	1 1/16	1 1/4	3.73	94.7	3.83	97.2	1.82	46.2	1
12GE-14FJX90L	7100-01755	3/4	19.0	1 3/16-12	1 1/16	1 3/8	3.93	99.8	4.13	105.0	2.13	54.0	1
16GE-16FJX90L	7100-01775	1	25.4	1 5/16-12	1 3/8	1 1/2	4.33	110.0	4.52	114.9	2.29	58.1	1
16GE-16FJX90L	7100-02085	1	25.4	1 5/16-12	1 3/8	1 1/2	4.33	110.0	4.52	114.9	2.29	58.1	1
BULK PACK													
4GE-4FJX90LXBULK	7100-1149	1/4	6.4	7/16-20	1/2	9/16	1.80	45.7	2.06	52.2	1.03	26.2	290
4GE-5FJX90LXBULK	7100-1152	1/4	6.4	1/2-20	1/2	5/8	1.79	45.7	2.17	55.2	1.15	29.2	150
4GE-6FJX90LXBULK	7100-1155	1/4	6.4	9/16-18	1/2	11/16	2.13	54.0	2.80	71.0	1.77	45.0	150
6GE-6FJX90LXBULK	7100-1158	3/8	9.5	9/16-18	5/8	11/16	2.18	55.4	2.60	66.0	1.50	38.1	150
6GE-8FJX90LXBULK	7100-1161	3/8	9.5	3/4-16	5/8	7/8	2.43	61.7	2.54	64.4	1.44	36.5	140
8GE-8FJX90LXBULK	7100-2003	1/2	12.7	3/4	13/16	7/8	2.52	64.0	2.91	74.0	1.44	36.6	100
8GE-10FJX90LXBULK	7100-0167	1/2	12.7	7/8-14	1	1	2.57	65.3	3.15	80.1	1.68	42.7	80
10GE-10FJX90LXBULK	7100-0717	5/8	15.8	7/8-14	15/16	1	2.57	65.3	3.19	81.0	1.71	43.5	75
10GE-12FJX90LXBULK	7100-0724	5/8	15.8	1 1/16-12	15/16	1 1/4	3.78	96.0	3.35	85.0	1.87	47.5	50
12GE-12FJX90LXBULK	7100-0173	3/4	19.0	1 1/16-12	1 1/16	1 1/4	3.73	94.7	3.83	97.2	1.82	46.2	40
16GE-16FJX90LXBULK	7100-0177	1	25.4	1 5/16-12	1 3/8	1 1/2	4.33	110.0	4.52	114.9	2.29	58.1	20
16GE-16FJX90LXBULK	7100-0208	1	25.4	1 5/16-12	1 3/8	1 1/2	4.33	110.0	4.52	114.9	2.29	58.1	20

- EQUIPMENT
- HOSE/CPLG. SELECTION
- GLOBALSPIRAL COUPLINGS
- PCM/PCS FERRULES
- MEGACRIMP COUPLINGS
- POWER CRIMP COUPLINGS
- LOW PRESSURE COUPLINGS
- POLARSEAL COUPLINGS
- C14 COUPLINGS
- PCTS THERMO-PLASTIC COUPLINGS
- FIELD ATTACHABLE G1 & G2 COUPLINGS
- FIELD ATTACHABLE C5 COUPLINGS
- SURELOK AIR BRAKE COUPLINGS
- QUICK DISCONNECT COUPLERS
- NEW BALL VALVES
- ACCESSORIES
- EQUIPMENT AND PARTS





Female JIC 37° Flare Swivel - 90° Extra Long Bent Tube English Hex

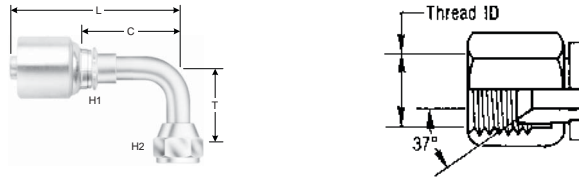

Descr.	Prod. No.	⊖			H1	H2	T		L		C		Std. Pack
		"	mm				"	mm	"	mm	"	mm	
STANDARD PACK													
8GE-10FJX90-089	7100-01805	1/2	12.7	7/8-14	13/16	1	3.50	89.0	3.65	92.8	2.18	55.3	1
12GE-16FJX90-074	7100-11705	3/4	19.0	1 5/16-12	1 3/8	1 1/2	2.91	74.0	4.77	121.3	2.77	70.3	1
20GE-20FJX90-070	7100-07255	1 1/4	31.7	1 1/4	1 3/4	2	2.75	70.0	6.22	158.0	3.90	99.0	1
BULK PACK													
12GE-16FJX90-074XBULK	7100-1170	3/4	19.0	1 5/16-12	1 3/8	1 1/2	2.91	74.0	4.77	121.3	2.77	70.3	25

Female JIC 37° Flare Swivel - 90° Long Bent Tube

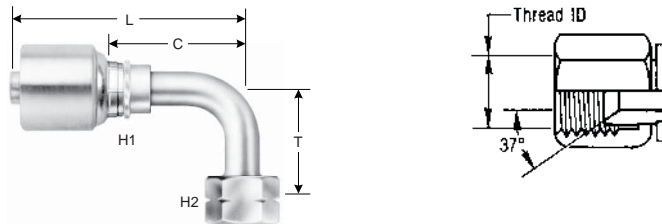

Descr.	Prod. No.	⊖			H1	H2	T		L		C		Std. Pack
		"	mm				mm	mm	"	mm	"	mm	
STANDARD PACK													
20G-20FJX90L	7103-41585	1/4	31.7	1 5/8-12	44.4	50.0	5.08	129.0	6.22	158.0	3.90	99.0	1

Female JIC 37° Flare Swivel - 90° Block English Hex

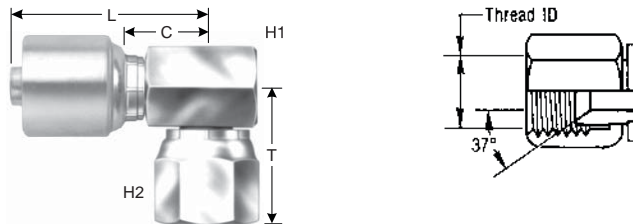

Descr.	Prod. No.	⊖			H1	H2	T		L		C		Std. Pack
		"	mm				"	mm	"	mm	"	mm	
STANDARD PACK													
12GE-16FJX90BL	7101-50545	3/4	19.0	1 5/16-12	1 3/8	1 1/2	2.09	53.2	3.74	95.0	1.76	44.0	1

EQUIPMENT

HOSE/CPLG. SELECTION

GLOBALSPIRAL COUPLINGS

PCM/PCS FERRULES

MEGACRIMP COUPLINGS

POWER CRIMP COUPLINGS

LOW PRESSURE COUPLINGS

POLARSEAL COUPLINGS

C14 COUPLINGS

PCTS THERMO-PLASTIC COUPLINGS

FIELD ATTACHABLE G1 & G2 COUPLINGS

FIELD ATTACHABLE C5 COUPLINGS

SURELOK AIR BRAKE COUPLINGS

QUICK DISCONNECT COUPLERS

NEW BALL VALVES

ACCESSORIES

EQUIPMENT AND PARTS





MegaCrimp® Couplings

Male SAE 45° Flare

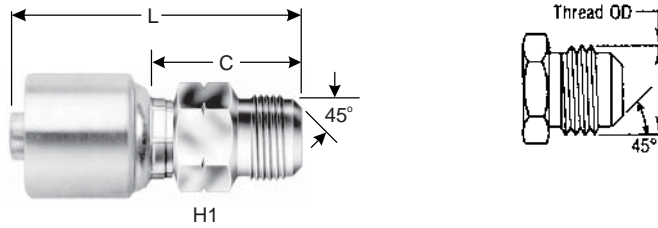

Descr.	Prod. No.	⊖		🌀	H1	H2	L		C		Std. Pack
		"	mm		"	"	"	mm	"	mm	
STANDARD PACK											
4G-4MS	7100-11815	1/4	6.4	7/16-20	1/2	—	2.11	53.5	1.08	27.5	1
4G-5MS	7100-11825	1/4	6.4	1/2-20	1/2	—	2.16	54.8	1.13	28.8	1
6G-6MS	7100-11835	3/8	9.5	5/8-18	5/8	—	2.28	58.0	1.19	30.1	1
6G-8MS	7100-11845	3/8	9.5	3/4-16	11/16	—	2.42	61.4	1.32	33.4	1
8G-8MS	7100-01855	1/2	12.7	3/4-16	13/16	—	2.78	70.5	1.30	33.0	1
8G-10MS	7100-01865	1/2	12.7	7/8-14	7/8	—	2.89	73.5	1.42	36.0	1
12G-12MS	7100-01875	3/4	19.0	1 1/16-14	1 1/16	—	3.78	96.0	1.77	45.0	1
BULK PACK											
6G-6MSXBULK	7100-1183	3/8	9.5	5/8-18	5/8	—	2.28	58.0	1.19	30.1	150
12G-12MSXBULK	7100-0187	3/4	19.0	1 1/16-14	1 1/16	—	3.78	96.0	1.77	45.0	60

Female SAE 45° Flare Swivel

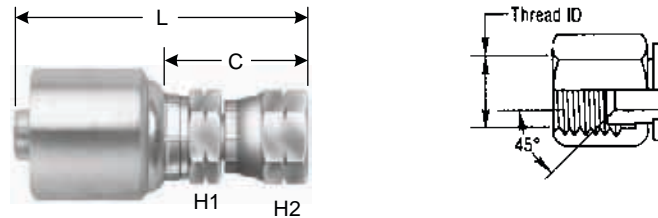

Descr.	Prod. No.	⊖		🌀	H1	H2	L		C		Std. Pack
		"	mm		"	"	"	mm	"	mm	
STANDARD PACK											
4G-4FSX	7100-11885	1/4	6.4	7/16-20	1/2	9/16	2.24	57.0	1.22	31.0	1
4G-5FSX	7100-11895	1/4	6.4	1/2-20	1/2	11/16	2.21	56.2	1.19	30.2	1
4G-6FSX	7100-11905	1/4	6.4	5/8-18	5/8	3/4	2.31	58.7	1.28	32.6	1
5G-6FSX	7100-11935	5/16	7.9	5/8-18	5/8	3/4	2.44	62.1	1.34	34.1	1
6G-6FSX	7100-11915	3/8	9.5	5/8-18	5/8	3/4	2.45	62.1	1.35	34.2	5
6G-8FSX	7100-11925	3/8	9.5	3/4-16	11/16	7/8	2.48	63.1	1.38	35.1	1
8G-8FSX	7100-01935	1/2	12.7	3/4-16	13/16	7/8	2.82	71.6	1.34	34.1	1
8G-10FSX	7100-01945	1/2	12.7	7/8-14	13/16	1 1/16	2.99	75.9	1.51	38.4	1
12G-12FSX	7100-01955	3/4	19.0	1 1/16-14	1 1/16	1 1/4	3.68	93.5	1.67	42.5	1
BULK PACK											
4G-4FSX XBULK	7100-1188	1/4	6.4	7/16-20	1/2	9/16	2.24	57.0	1.22	31.0	170
4G-6FSX XBULK	7100-1190	1/4	6.4	5/8-18	5/8	3/4	2.31	58.7	1.28	32.6	50
6G-6FSX XBULK	7100-1191	3/8	9.5	5/8-18	5/8	3/4	2.45	62.1	1.35	34.2	200
6G-8FSX XBULK	7100-1192	3/8	9.5	3/4-16	11/16	7/8	2.48	63.1	1.38	35.1	150
8G-8FSX XBULK	7100-0193	1/2	12.7	3/4-16	13/16	7/8	2.82	71.6	1.34	34.1	140
8G-10FSX XBULK	7100-0194	1/2	12.7	7/8-14	13/16	1 1/16	2.99	75.9	1.51	38.4	100







Female SAE 45° Flare Swivel - Cont'd

Descr.	Prod. No.	⊖			H1	H2	L		C		Std. Pack
		"	mm		"	"	"	mm	"	mm	
12G-12FSX XBULK	7100-0195	3/4	19.0	1 1/16-14	1 1/16	1 1/4	3.68	93.5	1.67	42.5	50

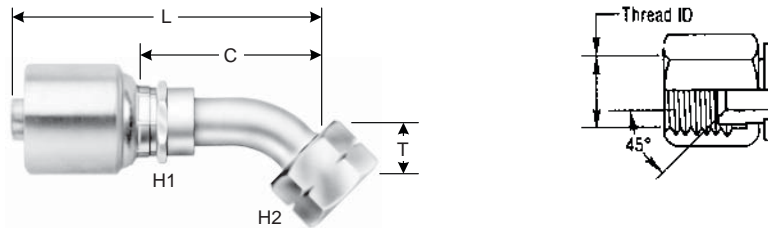
Female SAE 45° Flare Swivel - 45° Bent Tube



Descr.	Prod. No.	⊖			H1	H2	T		L		C		Std. Pack
		"	mm		"	"	"	mm	"	mm	"	mm	
STANDARD PACK													
4G-4FSX45	7100-11965	1/4	6.4	7/16-20	1/2	1 9/16	.33	8.4	2.34	59.5	1.32	33.5	1
4G-5FSX45-009	7100-01965	1/4	6.4	1/2-20	5/8	1 1/6	.36	9.1	2.63	66.9	1.61	40.9	1
6G-6FSX45	7100-11995	3/8	9.5	5/8-18	5/8	3/4	.39	9.9	2.74	69.5	1.64	41.6	1
6G-8FSX45-014	7100-02035	3/8	9.5	3/4-16	5/8	7/8	.55	14.0	3.46	87.8	2.36	59.9	1
8G-8FSX45	7100-02015	1/2	12.7	3/4-16	13/16	7/8	.55	14.0	3.31	84.0	1.83	46.5	1
8G-10FSX45	7100-02025	1/2	12.7	7/8-14	13/16	7/8	.55	14.0	3.31	84.0	1.83	46.5	1
8G-10FSX45-016	7100-02055	1/2	12.7	7/8-14	13/16	1	.75	19.1	3.66	93.1	2.19	55.6	1
12G-12FSX45	7100-02045	3/4	19.1	1 1/16-14	1 1/16	1 1/4	.78	19.8	4.37	111.0	2.36	60.0	1
BULK PACK													
8G-10FSX45XBULK	7100-0202	1/2	12.7	7/8-14	13/16	1	.75	19.1	3.66	93.1	2.19	55.6	100

Female SAE 45° Flare Swivel - 90° Bent Tube

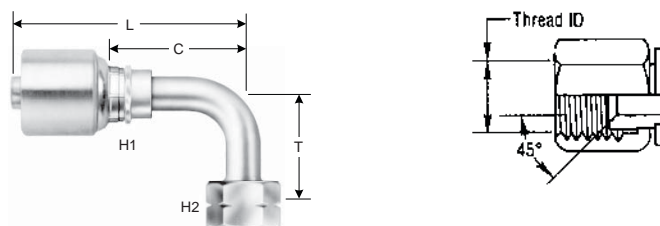

Descr.	Prod. No.	⊖			H1	H2	T		L		C		Std. Pack
		"	mm		"	"	"	mm	"	mm	"	mm	
STANDARD PACK													
4G-4FSX90	7100-12055	1/4	6.4	7/16-20	1/2	9/16	1.24	31.5	2.05	52.0	1.02	26.0	1
4G-5FSX90-046	7100-01985	1/4	6.4	1/2-20	1/2	5/8	.85	21.6	2.47	62.8	1.45	36.8	1
5G-6FSX90-022	7100-02005	5/16	7.9	5/8-18	5/8	3/4	.85	2.2	2.77	70.4	1.67	42.4	1
6G-6FSX90	7100-12105	3/8	9.5	5/8-18	5/8	3/4	1.52	38.5	2.36	60.0	1.26	32.1	1
6G-6FSX90-055	7100-01995	3/8	9.5	5/8-18	5/8	3/4	2.18	55.4	2.83	71.8	1.73	43.9	1
6G-8FSX90	7100-02125	3/8	9.5	3/4-16	5/8	7/8	1.75	44.5	2.50	63.5	1.40	35.6	1
8G-8FSX90	7100-02135	1/2	12.7	3/4-16	13/16	7/8	1.75	44.5	2.93	74.5	1.46	37.0	1
8G-10FSX90-031	7100-02065	1/2	12.7	7/8-14	13/16	1	1.23	31.2	3.29	83.5	1.81	46.0	1
12G-12FSX90	7100-02185	3/4	19.0	1 1/16-14	1 1/16	1 1/4	2.78	70.5	3.94	100.0	1.93	49.0	1

EQUIPMENT

HOSE/CPLG. SELECTION

GLOBAL SPIRAL COUPLINGS

PCM/PCS FERRULES

MEGACRIMP COUPLINGS

POWER CRIMP COUPLINGS

LOW PRESSURE COUPLINGS

POLARSEAL COUPLINGS

C14 COUPLINGS

PCTS THERMO-PLASTIC COUPLINGS

FIELD ATTACHABLE G1 & G2 COUPLINGS

FIELD ATTACHABLE C5 COUPLINGS

SURELOK AIR BRAKE COUPLINGS

QUICK DISCONNECT COUPLERS

NEW BALL VALVES

ACCESSORIES

EQUIPMENT AND PARTS





MegaCrimp® Couplings

EQUIPMENT

HOSE/CPLG. SELECTION

GLOBALSPIRAL COUPLINGS

PCM/PCS FERRULES

MEGACRIMP COUPLINGS

POWER CRIMP COUPLINGS

LOW PRESSURE COUPLINGS

POLARSEAL COUPLINGS

C14 COUPLINGS

PCTS THERMO-PLASTIC COUPLINGS

FIELD ATTACHABLE G1 & G2 COUPLINGS

FIELD ATTACHABLE C5 COUPLINGS

SURELOK AIR BRAKE COUPLINGS

QUICK DISCONNECT COUPLERS

NEW BALL VALVES

ACCESSORIES

EQUIPMENT AND PARTS

Female SAE 45° Flare Swivel - 90° Bent Tube - Cont'd

Descr.	Prod. No.	⊖			H1	H2	T		L		C		Std. Pack
		"	mm		"	"	"	mm	"	mm	"	mm	
BULK PACK													
6G-6FSX90XBULK	7100-1210	3/8	9.5	5/8-18	5/8	3/4	1.52	38.5	2.36	60.0	1.26	32.1	150

Male Quick-Lok High



Descr.	Prod. No.	⊖		L		C		Std. Pack
		"	mm	"	mm	"	mm	
STANDARD PACK								
4G-4MQLH	7209-32005	1/4	6.4	2.64	66.8	1.61	41.0	1
6G-6MQLH	7209-32025	3/8	9.5	2.72	68.8	1.62	41.1	1
8G-8MQLH	7209-32055	1/2	12.7	3.11	79.0	1.63	41.5	1
10G-10MQLH	7209-32085	5/8	15.9	3.11	79.0	1.63	41.5	1
12G-12MQLH	7209-32105	3/4	19.1	3.66	93.0	1.65	42.0	1
16G-16MQLH	7209-32125	1	25.4	3.98	101.0	1.74	44.2	1
BULK PACK								
4G-4MQLHXBULK	7209-3200	1/4	6.4	2.64	66.8	1.61	41.0	280
6G-6MQLHXBULK	7209-3202	3/8	9.5	2.72	68.8	1.62	41.1	200
8G-8MQLHXBULK	7209-3205	1/2	12.7	3.11	79.0	1.63	41.5	125
10G-10MQLHXBULK	7209-3208	5/8	15.9	3.11	79.0	1.63	41.5	100
12G-12MQLHXBULK	7209-3210	3/4	19.1	3.66	93.0	1.65	42.0	50
16G-16MQLHXBULK	7209-3212	1	25.4	3.98	101.0	1.74	44.2	25

Male Quick-Lok High - 45° Bent Tube



Descr.	Prod. No.	⊖		T		L		C		Std. Pack
		"	mm	"	mm	"	mm	"	mm	
STANDARD PACK										
4G-4MQLH45S-008	7209-33005	1/4	6.4	.32	8.0	2.96	75.1	1.93	49.1	1





Male Quick-Lok High - 45° Bent Tube - Cont'd

Descr.	Prod. No.	Ø		T		L		C		Std. Pack
		"	mm	"	mm	"	mm	"	mm	
6G-6MQLH45S-008	7209-33015	3/8	9.5	.32	8.0	3.21	81.6	2.11	53.7	1
8G-8MQLH45S-010	7209-33025	1/2	12.7	.39	10.0	3.77	95.7	2.29	58.2	1
10G-10MQLH45S-013	7209-33045	5/8	15.9	.51	13.0	4.12	104.6	2.64	67.1	1
12G-12MQLH45S-014	7209-33055	3/4	19.1	.55	14.0	4.88	124.0	2.87	73.0	1
16G-16MQLH45S-017	7209-33065	1	25.4	.66	17.0	5.49	139.5	3.26	82.7	1
BULK PACK										
4G-4MQLH45S-008XBULK	7209-3300	1/4	6.4	.32	8.0	2.96	75.1	1.93	49.1	150
6G-6MQLH45S-008XBULK	7209-3301	3/8	9.5	.32	8.0	3.21	81.6	2.11	53.7	125
8G-8MQLH45S-010XBULK	7209-3302	1/2	12.7	.39	10.0	3.77	95.7	2.29	58.2	100
10G-10MQLH45S-013XBULK	7209-3304	5/8	15.9	.51	13.0	4.12	104.6	2.64	67.1	75
12G-12MQLH45S-014XBULK	7209-3305	3/4	19.1	.55	14.0	4.88	124.0	2.87	73.0	50
16G-16MQLH45S-017XBULK	7209-3306	1	25.4	.66	17.0	5.49	139.5	3.26	82.7	25

Male Quick-Lok High - 90° Short Bent Tube

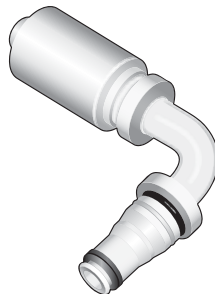

Descr.	Prod. No.	Ø		T		L		C		Std. Pack
		"	mm	"	mm	"	mm	"	mm	
STANDARD PACK										
4G-4MQLH90S-018	7209-34005	1/4	6.4	.70	18.0	2.19	55.6	1.69	29.6	1
6G-6MQLH90S-020	7209-34045	3/8	9.5	.78	20.0	2.47	62.8	1.37	34.8	1
8G-8MQLH90S-026	7209-34085	1/2	12.7	1.02	26.0	3.16	80.3	1.69	42.9	1
10G-10MQLH90S-033	7209-34115	5/8	15.9	1.29	33.0	3.55	90.1	2.07	52.6	1
12G-12MQLH90S-037	7209-34155	3/4	19.1	1.45	37.0	4.33	110.1	2.33	59.1	1
16G-16MQLH90S-044	7209-34195	1	25.4	1.73	44.0	5.47	139.0	3.24	82.3	1
BULK PACK										
4G-4MQLH90S-018XBULK	7209-3400	1/4	6.4	.70	18.0	2.19	55.6	1.69	29.6	150
6G-6MQLH90S-020XBULK	7209-3404	3/8	9.5	.78	20.0	2.47	62.8	1.37	34.8	125
8G-8MQLH90S-026XBULK	7209-3408	1/2	12.7	1.02	26.0	3.16	80.3	1.69	42.9	100
10G-10MQLH90S-033XBULK	7209-3411	5/8	15.9	1.29	33.0	3.55	90.1	2.07	52.6	75
12G-12MQLH90S-037XBULK	7209-3415	3/4	19.1	1.45	37.0	4.33	110.1	2.33	59.1	50
16G-16MQLH90S-044XBULK	7209-3419	1	25.4	1.73	44.0	5.47	139.0	3.24	82.3	25

EQUIPMENT
HOSE/CPLG. SELECTION
GLOBAL SPIRAL COUPLINGS
PCM/PCS FERRULES
MEGACRIMP COUPLINGS
POWER CRIMP COUPLINGS
LOW PRESSURE COUPLINGS
POLARSEAL COUPLINGS
C14 COUPLINGS
PCTS THERMO-PLASTIC COUPLINGS
FIELD ATTACHABLE G1 & G2 COUPLINGS
FIELD ATTACHABLE C5 COUPLINGS
SURELOK AIR BRAKE COUPLINGS
QUICK DISCONNECT COUPLERS
NEW BALL VALVES
ACCESSORIES
EQUIPMENT AND PARTS



MegaCrimp® Couplings



Male Quick-Lok High - 90° Long Bent Tube



EQUIPMENT

HOSE/CPLG. SELECTION

GLOBALSPIRAL COUPLINGS

PCM/PCS FERRULES

MEGACRIMP COUPLINGS

POWER CRIMP COUPLINGS

LOW PRESSURE COUPLINGS

POLARSEAL COUPLINGS

C14 COUPLINGS

PCTS THERMO-PLASTIC COUPLINGS

FIELD ATTACHABLE G1 & G2 COUPLINGS

FIELD ATTACHABLE C5 COUPLINGS

SURELOK AIR BRAKE COUPLINGS

QUICK DISCONNECT COUPLERS

NEW BALL VALVES

ACCESSORIES

EQUIPMENT AND PARTS

Descr.	Prod. No.	⊖		T		L		C		Std. Pack
		"	mm	"	mm	"	mm	"	mm	
STANDARD PACK										
4G-4MQLH90L-039	7209-34015	1/4	19.1	1.53	39.0	2.19	55.6	1.17	29.6	1
6G-6MQLH90L-046	7209-34055	3/8	9.5	1.81	46.0	2.40	60.9	1.30	32.9	1
8G-8MQLH90L-057	7209-34095	1/2	12.7	2.24	57.0	3.04	77.1	1.56	39.7	1
10G-10MQLH90L-065	7209-34125	5/8	15.9	2.55	65.0	3.72	94.4	2.24	57.0	1
12G-12MQLH90L-075	7209-34165	3/4	19.1	2.95	75.0	4.20	106.7	2.19	55.7	1
16G-16MQLH90L-103	7209-34215	1	25.4	4.05	103.0	4.87	123.7	2.63	66.9	1
BULK PACK										
4G-4MQLH90L-039XBULK	7209-3401	1/4	19.1	1.53	39.0	2.19	55.6	1.17	29.6	150
6G-6MQLH90L-046XBULK	7209-3405	3/8	9.5	1.81	46.0	2.40	60.9	1.30	32.9	125
8G-8MQLH90L-057XBULK	7209-3409	1/2	12.7	2.24	57.0	3.04	77.1	1.56	39.7	100
10G-10MQLH90L-065XBULK	7209-3412	5/8	15.9	2.55	65.0	3.72	94.4	2.24	57.0	75
12G-12MQLH90L-075XBULK	7209-3416	3/4	19.1	2.95	75.0	4.20	106.7	2.19	55.7	50
16G-16MQLH90L-103XBULK	7209-3421	1	25.4	4.05	103.0	4.87	123.7	2.63	66.9	25

Female Quick-Lok High to Male O-Ring Boss Adapter



Descr.	Prod. No.	⊖		🌀	H1	H2	L		Std. Pack
		"	mm		mm	mm	"	mm	
STANDARD PACK									
4FQLH-4MBS	7209-05025	1/4	6.4	7/16-20	19.0	—	1.65	42.0	1
4FQLH-6MB	7209-05035	1/4	6.4	9/16-18	19.0	—	1.65	42.0	1
6FQLH-4MB	7209-05075	3/8	9.5	7/16-20	22.0	—	1.65	42.0	1
6FQLH-6MB	7209-05085	3/8	9.5	9/16-18	22.0	—	1.69	43.0	1
6FQLH-8MB	7209-05095	3/8	9.5	3/4-16	24.0	—	1.69	43.0	5
6MB-8FQLH	7209-05135	1/2	12.7	9/16-18	24.0	—	1.71	43.5	1
8FQLH-8MBS	7209-05145	1/2	12.7	3/4-16	24.0	—	1.75	44.5	1
8FQLH-10MB	7209-05155	1/2	12.7	7/8-14	27.0	—	1.81	46.0	1
8MB-10FQLH	7209-05195	5/8	15.9	3/4-16	27.0	—	1.85	47.0	1
10MB-10FQLH	7209-05205	5/8	15.9	7/8-14	27.0	—	1.85	47.0	1
12FQLH-10MB	7209-05255	3/4	19.1	7/8-14	32.0	—	1.88	48.0	1



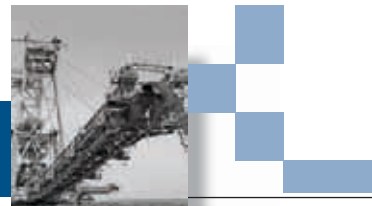



Female Quick-Lok High to Male O-Ring Boss Adapter - Cont'd

Descr.	Prod. No.	⊖			H1	H2	L		Std. Pack
		"	mm		mm	mm	"	mm	
12FQLH-12MB	7209-05265	3/4	19.1	1 1/16-12	32.0	—	1.96	50.0	1
12FQLH-16MB	7209-05275	3/4	19.1	1 5/16-12	41.0	—	1.96	50.0	1
12MB-10FQLH	7209-05215	5/8	15.9	1 1/16-12	27.0	—	1.88	48.0	1
12MB-16FQLH	7209-05315	1	25.4	1 1/16-12	41.0	—	2.08	53.0	1
16FQLH-16MB	7209-05325	1	25.4	1 5/16-12	41.0	—	1.96	50.0	1
BULK PACK									
4FQLH-4MBSXBULK	7209-0502	1/4	6.4	7/16-20	19.0	—	1.65	42.0	200
4FQLH-6MBSXBULK	7209-0503	1/4	6.4	9/16-18	19.0	—	1.65	42.0	200
6FQLH-4MBSXBULK	7209-0507	3/8	9.5	7/16-20	22.0	—	1.65	42.0	150
6FQLH-6MBSXBULK	7209-0508	3/8	9.5	9/16-18	22.0	—	1.69	43.0	175
6FQLH-8MBSXBULK	7209-0509	3/8	9.5	3/4-16	24.0	—	1.69	43.0	200
8FQLH-6MBSXBULK	7209-0513	1/2	12.7	9/16-18	24.0	—	1.71	43.5	150
8FQLH-8MBSXBULK	7209-0514	1/2	12.7	3/4-16	24.0	—	1.75	44.5	100
8FQLH-10MBSXBULK	7209-0515	1/2	12.7	7/8-14	27.0	—	1.81	46.0	100
10FQLH-8MBSXBULK	7209-0519	5/8	15.9	3/4-16	27.0	—	1.85	47.0	100
10FQLH-10MBSXBULK	7209-0520	5/8	15.9	7/8-14	27.0	—	1.85	47.0	125
10FQLH-12MBXBULK	7209-0521	5/8	15.9	1 1/16-12	27.0	—	1.88	48.0	100
12FQLH-10MBSXBULK	7209-0525	3/4	19.1	7/8-14	32.0	—	1.88	48.0	100
12FQLH-12MBXBULK	7209-0526	3/4	19.1	1 1/16-12	32.0	—	1.96	50.0	100
12FQLH-16MBXBULK	7209-0527	3/4	19.1	1 5/16-12	41.0	—	1.96	50.0	75
16FQLH-12MBSXBULK	7209-0531	1	25.4	1 1/16-12	41.0	—	2.08	53.0	75
16FQLH-16MBXBULK	7209-0532	1	25.4	1 5/16-12	41.0	—	1.96	50.0	50

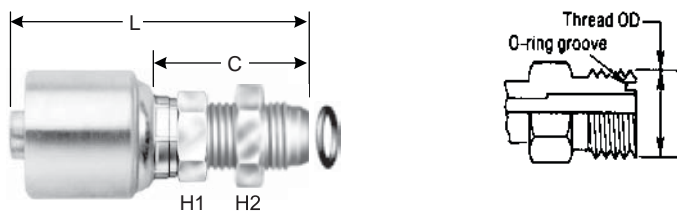
Male Flat-Face O-Ring Bulk Head Long Nose



Descr.	Prod. No.	⊖			H1	H2	L		C		Std. Pack
		"	mm		"	"	"	mm	"	mm	
STANDARD PACK											
8G-8MFFORBKHDLN	7101-50565	1/2	12.7	13/16-16	1 1/8	1 1/8	3.55	90.2	2.07	52.6	1

EQUIPMENT
HOSE/CPLG. SELECTION
GLOBAL SPIRAL COUPLINGS
PCM/PCS FERRULES
MEGACRIMP COUPLINGS
POWER CRIMP COUPLINGS
LOW PRESSURE COUPLINGS
POLARSEAL COUPLINGS
C14 COUPLINGS
PCTS THERMO-PLASTIC COUPLINGS
FIELD ATTACHABLE G1 & G2 COUPLINGS
FIELD ATTACHABLE C5 COUPLINGS
SURELOK AIR BRAKE COUPLINGS
QUICK DISCONNECT COUPLERS
NEW BALL VALVES
ACCESSORIES
EQUIPMENT AND PARTS







MegaCrimp® Couplings

Male Flat-Face O-Ring Metric Hex

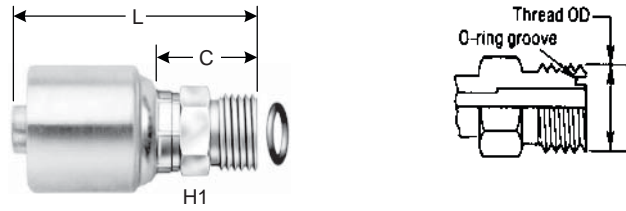
SAE J1453 Captive O-Ring Groove for Improved O-Ring Retention.





DESCR.	Prod. No.	Ø			H1	H2	L		C		Std. Pack	
		"	mm		mm	mm	"	mm	"	mm		
STANDARD PACK												
4G-4MFFOR	7104-16045	1/4	6.4	9/16-18	17.0	—	1.91	48.5	.89	22.5	1	
4G-6MFFOR	7104-16055	1/4	6.4	11/16-16	19.0	—	2.13	54.0	1.10	28.0	1	
LOW PRESSURE COUPLINGS	5G-6MFFOR	7104-16065	5/16	7.9	11/16-16	19.0	—	2.20	56.0	1.10	28.0	1
	6G-6MFFOR	7104-16075	3/8	9.5	11/16-16	19.0	—	2.20	56.0	1.11	28.1	1
	6G-8MFFOR	7104-16085	3/8	9.5	13/16-16	22.0	—	2.32	59.0	1.22	31.1	1
POLARSEAL COUPLINGS	6G-10MFFOR	7104-16095	3/8	9.5	1-14	27.0	—	2.52	64.0	1.42	36.1	1
	8G-8MFFOR	7104-16115	1/2	12.7	13/16-16	22.0	—	2.69	68.2	1.21	30.7	1
	8G-10MFFOR	7104-16125	1/2	12.7	1-14	27.0	—	2.87	73.0	1.40	35.5	1
C14 COUPLINGS	8G-12MFFOR	7104-16135	1/2	12.7	1 3/16-12	32.0	—	3.01	76.5	1.53	39.0	1
	10G-10MFFOR	7104-16155	5/8	15.8	1-14	27.0	—	2.70	68.5	1.22	31.0	1
	10G-12MFFOR	7104-16165	5/8	15.8	1 3/16-12	32.0	—	2.83	72.0	1.36	34.5	1
PCTS THERMO-PLASTIC COUPLINGS	12G-12MFFOR	7104-16185	3/4	19.0	1 3/16-12	32.0	—	3.54	90.0	1.54	39.0	1
	12G-16MFFOR	7104-16195	3/4	19.0	1 7/16-12	41.0	—	3.74	95.0	1.73	44.0	1
	16G-16MFFOR	7104-16215	1	25.4	1 7/16-12	41.0	—	4.02	102.0	1.78	45.2	1
FIELD ATTACHABLE G1 & G2 COUPLINGS	16G-20MFFOR	7104-16225	1	25.4	1 11/16-12	46.0	—	4.13	105.0	1.90	48.2	1
	20G-20MFFOR	7104-16245	1 1/4	31.7	1 11/16-12	46.0	—	4.29	109.0	1.97	50.0	1
	BULK PACK											
FIELD ATTACHABLE G1 & G2 COUPLINGS	4G-4MFFORXBULK	7104-1604	1/4	6.4	9/16-18	17.0	—	1.91	48.5	.89	22.5	200
	4G-6MFFORXBULK	7104-1605	1/4	6.4	11/16-16	19.0	—	2.13	54.0	1.10	28.0	150
	6G-6MFFORXBULK	7104-1607	3/8	9.5	11/16-16	19.0	—	2.20	56.0	1.11	28.1	215
	6G-8MFFORXBULK	7104-1608	3/8	9.5	13/16-16	22.0	—	2.32	59.0	1.22	31.1	175
	6G-10MFFORXBULK	7104-1609	3/8	9.5	1-14	27.0	—	2.52	64.0	1.42	36.1	75
FIELD ATTACHABLE C5 COUPLINGS	8G-8MFFORXBULK	7104-1611	1/2	12.7	13/16-16	22.0	—	2.69	68.2	1.21	30.7	100
	8G-10MFFORXBULK	7104-1612	1/2	12.7	1-14	27.0	—	2.87	73.0	1.40	35.5	100
	10G-10MFFORXBULK	7104-1615	5/8	15.8	1-14	27.0	—	2.70	68.5	1.22	31.0	50
	10G-12MFFORXBULK	7104-1616	5/8	15.8	1 3/16-12	32.0	—	2.83	72.0	1.36	34.5	50
	12G-12MFFORXBULK	7104-1618	3/4	19.0	1 3/16-12	32.0	—	3.54	90.0	1.54	39.0	50
SURELOK AIR BRAKE COUPLINGS	12G-16MFFORXBULK	7104-1619	3/4	19.0	1 7/16-12	41.0	—	3.74	95.0	1.73	44.0	30
	16G-16MFFORXBULK	7104-1621	1	25.4	1 7/16-12	41.0	—	4.02	102.0	1.78	45.2	25
	20G-20MFFORXBULK	7104-1624	1 1/4	31.7	1 11/16-12	46.0	—	4.29	109.0	1.97	50.0	25



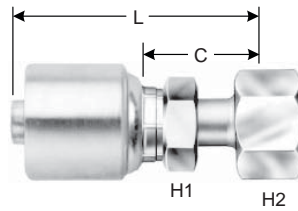

Female Flat-Face O-Ring Swivel Metric Hex



Descr.	Prod. No.	⊖			H1	H2	L		C		Std. Pack
		"	mm		mm	mm	"	mm	"	mm	
STANDARD PACK											
4G-8FFORX	7104-19075	1/4	6.4	13/16-16	12.7	24.0	2.23	56.9	1.21	31.0	1
20G-24FFORX	7104-19385	1 1/4	31.8	2-12	50.0	60.0	4.47	113.8	2.05	52.3	1
BULK PACK											
20G-24FFORXXBULK	7104-1938	1 1/4	31.8	1 7/8-12	50.0	60.0	4.47	113.8	2.05	52.3	20

Female Flat-Face O-Ring Swivel Metric Hex - 45° Short Bent Tube

SAE J1453 O-Ring Face Seal.

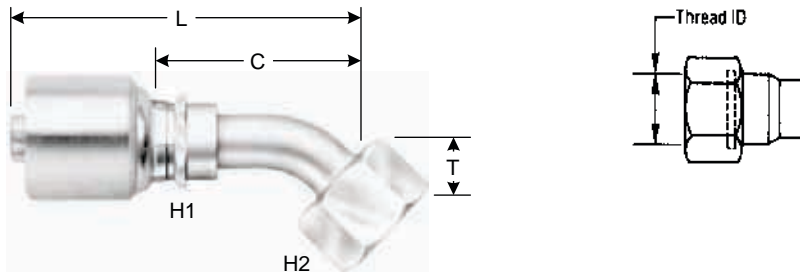

Descr.	Prod. No.	⊖			H1	H2	T		L		C		Std. Pack
		"	mm		mm	mm	"	mm	"	mm	"	mm	
STANDARD PACK													
4G-4FFORX45S	7104-22045	1/4	6.4	9/16-18	12.7	17.0	.39	10.0	2.57	65.2	1.54	39.2	1
4G-6FFORX45S	7104-22055	1/4	6.4	11/16-16	12.7	22.0	.43	11.0	2.70	68.5	1.67	42.5	1
5G-6FFORX45S	7104-22335	5/16	7.9	11/16-16	15.9	22.0	.43	11.0	2.73	69.4	1.63	41.4	1
6G-4FFORX45S	7104-22075	3/8	9.5	9/16-18	12.7	17.0	.39	10.0	2.60	68.5	1.50	42.5	1
6G-6FFORX45S	7104-22085	3/8	9.5	11/16-16	15.9	22.0	.43	11.0	2.75	69.8	1.65	41.9	1
6G-8FFORX45S	7104-22095	3/8	9.5	13/16-16	24.0	—	.59	15.0	3.35	85.2	2.26	57.3	1
8G-6FFORX45S	7104-22125	1/2	12.7	11/16-16	20.6	22.0	.43	11.0	3.57	90.7	2.09	53.2	1
8G-8FFORX45S	7104-22135	1/2	12.7	13/16-16	—	24.0	.59	15.0	3.50	89.0	2.03	51.6	1
8G-10FFORX45S	7104-22145	1/2	12.7	1-14	20.6	30.0	.63	16.0	3.98	101.0	2.50	63.5	1
8G-12FFORX45S	7104-22155	1/2	12.7	1 3/16-12	—	36.0	.83	21.0	4.34	110.3	2.87	72.8	1
10G-8FFORX45S	7104-22165	5/8	15.9	13/16-16	23.8	24.0	.59	15.0	3.80	96.8	2.32	59.2	1
10G-10FFORX45S	7104-22175	5/8	15.8	1-14	23.8	30.0	.59	16.0	3.96	100.5	2.50	63.0	1
10G-12FFORX45S	7104-22185	5/8	15.9	1 3/16-12	23.8	36.0	.83	21.0	4.17	105.9	2.69	68.4	1
12G-12FFORX45S	7104-22225	3/4	19.1	1 3/16-12	27.0	36.0	.83	21.0	4.66	118.4	2.65	67.4	1
12G-16FFORX45S	7104-22235	3/4	19.1	1 7/16-12	27.0	41.0	.94	24.0	4.80	122.0	2.80	71.0	1
16G-12FFORX45S	7104-22255	1	25.4	1 3/16-12	34.9	36.0	.83	21.0	5.22	132.5	2.98	75.7	1
16G-16FFORX45S	7104-22265	1	25.4	1 7/16-12	34.9	41.0	.94	24.0	5.78	146.9	3.55	90.1	1
20G-20FFORX45S	7104-22295	1 1/4	31.8	1 11/16-12	44.5	50.0	.98	25.0	6.22	158.0	3.90	99.0	1

EQUIPMENT
HOSE/CPLG. SELECTION
GLOBALSPIRAL COUPLINGS
PCM/PCS FERRULES
MEGACRIMP COUPLINGS
POWER CRIMP COUPLINGS
LOW PRESSURE COUPLINGS
POLARSEAL COUPLINGS
C14 COUPLINGS
PCTS THERMO-PLASTIC COUPLINGS
FIELD ATTACHABLE G1 & G2 COUPLINGS
FIELD ATTACHABLE C5 COUPLINGS
SURELOK AIR BRAKE COUPLINGS
QUICK DISCONNECT COUPLERS
NEW BALL VALVES
ACCESSORIES
EQUIPMENT AND PARTS







MegaCrimp® Couplings

Female Flat-Face O-Ring Swivel Metric Hex - 45° Short Bent Tube - Cont'd

DESCR.	PROD. NO.	⊖			H1	H2	T		L		C		STD. PACK
		"	mm				"	mm	"	mm	"	mm	
BULK PACK													
4G-4FFORX45SXBULK	7104-2204	1/4	6.4	9/16-18	12.7	17.0	.39	10.0	2.57	65.2	1.54	39.2	100
4G-6FFORX45SXBULK	7104-2205	1/4	6.4	11/16-16	12.7	22.0	.43	11.0	2.70	68.5	1.67	42.5	240
6G-6FFORX45SXBULK	7104-2208	3/8	9.5	11/16-16	15.9	22.0	.43	11.0	2.75	69.8	1.65	41.9	190
6G-8FFORX45SXBULK	7104-2209	3/8	9.5	13/16-16	15.9	22.0	.59	15.0	3.35	85.2	2.26	57.3	125
8G-8FFORX45SXBULK	7104-2213	1/2	12.7	13/16-16	—	24.0	.59	15.0	3.50	89.0	2.03	51.6	100
8G-10FFORX45SXBULK	7104-2214	1/2	12.7	1-14	20.6	30.0	.63	16.0	3.98	101.0	2.50	63.5	50
10G-10FFORX45SXBULK	7104-2217	5/8	15.9	1-14	23.8	30.0	.59	16.0	3.96	100.5	2.50	63.0	85
10G-12FFORX45SXBULK	7104-2218	5/8	15.9	1 3/16-12	23.8	36.0	.83	21.0	4.17	105.9	2.69	68.4	50
12G-12FFORX45SXBULK	7104-2222	3/4	19.1	1 3/16-12	27.0	36.0	.83	21.0	4.66	118.4	2.65	67.4	50
12G-16FFORX45SXBULK	7104-2223	3/4	19.1	1 7/16-12	27.0	41.0	.94	24.0	4.80	122.0	2.80	71.0	35
16G-16FFORX45SXBULK	7104-2226	1	25.4	1 7/16-12	34.9	41.0	.94	24.0	5.78	146.9	3.55	90.1	25
20G-20FFORX45SXBULK	7104-2229	1 1/4	31.8	1 11/16-12	44.5	50.0	.98	25.0	6.22	158.0	3.90	99.0	15

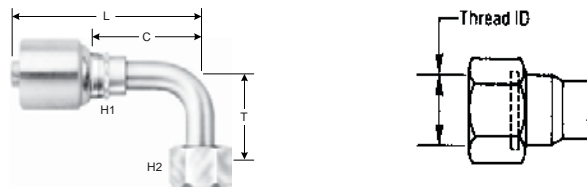
Female Flat-Face O-Ring Swivel Metric Hex - 90° Short Bent Tube



DESCR.	PROD. NO.	⊖			H1	H2	T		L		C		STD. PACK
		"	mm				"	mm	"	mm	"	mm	
STANDARD PACK													
4G-4FFORX90S	7104-24045	1/4	6.4	9/16-18	12.7	17.0	.83	21.0	2.37	60.2	1.35	34.4	1
4G-6FFORX90S	7104-24095	1/4	6.4	11/16-16	12.7	22.0	.91	23.0	2.50	63.4	1.47	37.4	1
4G-8FFORX90S	7104-24145	1/4	6.4	13/16-16	—	22.0	1.14	29.0	2.86	72.7	1.80	46.0	1
5G-6FFORX90S	7104-24955	5/16	7.9	11/16-16	15.9	22.0	.91	23.0	2.83	72.0	1.73	44.0	1
6G-4FFORX90S	7104-24195	3/8	9.5	9/16-18	15.9	17.0	.73	21.0	2.42	61.4	1.32	33.6	1
6G-6FFORX90S	7104-24245	3/8	9.5	11/16-16	15.9	22.0	.91	23.0	2.85	72.5	1.76	44.6	1
6G-8FFORX90S	7104-24295	3/8	9.5	13/16-16	15.9	22.0	1.14	29.0	2.87	73.0	1.78	45.1	1
8G-6FFORX90S	7104-24345	1/2	12.7	11/16-16	20.6	22.0	.91	23.0	3.29	83.5	1.81	46.0	1
8G-8FFORX90S	7104-24395	1/2	12.7	13/16-16	—	—	.91	23.0	3.30	83.9	1.83	46.5	1
8G-10FFORX90S	7104-24445	1/2	12.7	1-14	20.6	30.0	1.26	32.0	3.66	92.9	2.18	55.4	1
8G-12FFORX90S	7104-24475	1/2	12.7	1 3/16-12	—	36.0	1.89	48.0	4.05	102.9	2.57	65.4	1
10G-8FFORX90S	7104-24495	5/8	15.9	13/16-16	23.8	24.0	1.14	29.0	3.64	92.4	2.16	54.9	1
10G-10FFORX90S	7104-24545	5/8	15.9	1-14	23.8	30.0	1.26	32.0	3.64	92.5	2.17	55.0	1
10G-12FFORX90S	7104-24595	5/8	15.9	1 3/16-12	23.8	36.0	1.89	48.0	3.79	96.3	2.31	58.8	1
12G-10FFORX90S	7104-24635	3/4	19.1	1-14	27.0	36.0	1.26	32.0	4.09	104.0	2.09	53.0	1
12G-12FFORX90S	7104-24645	3/4	19.1	1 3/16-12	27.0	36.0	1.89	48.0	4.29	109.0	2.28	58.0	1
12G-16FFORX90S	7104-24695	3/4	19.1	1 7/16-12	34.9	41.0	2.20	56.0	5.06	128.5	3.05	77.5	1
16G-12FFORX90S	7104-24735	1	25.4	1 3/16-12	27.0	36.0	1.89	48.0	5.10	129.4	2.86	72.6	1
16G-16FFORX90S	7104-24745	1	25.4	1 7/16-12	34.9	41.0	2.20	56.0	5.11	129.9	2.88	73.1	1
20G-20FFORX90S	7104-24795	1 1/4	31.8	1 11/16-12	44.5	50.0	2.52	64.0	5.91	150.0	3.58	91.0	1
BULK PACK													
4G-4FFORX90SXBULK	7104-2404	1/4	6.4	9/16-18	12.7	17.0	.83	21.0	2.37	60.2	1.35	34.4	255
4G-6FFORX90SXBULK	7104-2409	1/4	6.4	11/16-16	12.7	22.0	.91	23.0	2.50	63.4	1.47	37.4	225







Female Flat-Face O-Ring Swivel Metric Hex - 90° Short Bent Tube - Cont'd

Descr.	Prod. No.	⊖			H1	H2	T		L		C		Std. Pack
		"	mm		mm	mm	"	mm	"	mm	"	mm	
4G-8FFORX90SXBULK	7104-2414	1/4	6.4	13/16-16	—	22.0	1.14	29.0	2.86	72.7	1.80	46.0	100
6G-6FFORX90SXBULK	7104-2424	3/8	9.5	11/16-16	15.9	22.0	.91	23.0	2.85	72.5	1.76	44.6	185
6G-8FFORX90SXBULK	7104-2429	3/8	9.5	13/16-16	15.9	22.0	1.14	29.0	2.87	73.0	1.78	45.1	125
8G-8FFORX90SXBULK	7104-2439	1/2	12.7	13/16-16	—	24.0	1.14	29.0	3.30	83.9	1.83	46.5	110
8G-10FFORX90SXBULK	7104-2444	1/2	12.7	1-14	20.6	30.0	1.26	32.0	3.66	92.9	2.18	55.4	75
10G-10FFORX90SXBULK	7104-2454	5/8	15.9	1-14	23.8	30.0	1.26	32.0	3.64	92.5	2.17	55.0	80
10G-12FFORX90SXBULK	7104-2459	5/8	15.9	1 3/16-12	23.8	36.0	1.89	48.0	3.79	96.3	2.31	58.8	50
12G-12FFORX90SXBULK	7104-2464	3/4	19.1	1 3/16-12	27.0	36.0	1.89	48.0	4.29	109.0	2.28	58.0	45
12G-16FFORX90SXBULK	7104-2469	3/4	19.1	1 7/16-12	34.9	41.0	2.20	56.0	5.06	128.5	3.05	77.5	30
16G-16FFORX90SXBULK	7104-2474	1	25.4	1 7/16-12	34.9	41.0	2.20	56.0	5.11	129.9	2.88	73.1	25
20G-20FFORX90SXBULK	7104-2479	1 1/4	31.8	1 11/16-12	44.5	50.0	2.52	64.0	5.91	150.0	3.58	91.0	15

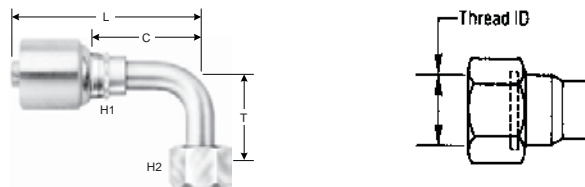
Female Flat-Face O-Ring Swivel Metric Hex - 90° Medium Bent Tube



Descr.	Prod. No.	⊖			H1	H2	T		L		C		Std. Pack
		"	mm		mm	mm	"	mm	"	mm	"	mm	
STANDARD PACK													
4G-4FFORX90M	7104-24055	1/4	6.4	9/16-18	12.7	17.0	1.26	32.0	2.21	56.2	1.90	30.2	1
4G-6FFORX90M	7104-24105	1/4	6.4	11/16-16	12.7	22.0	1.50	38.0	2.50	63.4	1.47	37.4	1
6G-6FFORX90M	7104-24255	3/8	9.5	11/16-16	15.9	22.0	1.50	38.0	2.50	63.6	1.41	35.7	1
6G-8FFORX90M	7104-24305	3/8	9.5	13/16-16	15.9	22.0	1.61	41.0	2.70	68.5	1.60	40.6	1
8G-8FFORX90M	7104-24405	1/2	12.7	13/16-16	—	24.0	1.61	41.0	3.30	83.9	1.83	46.5	1
8G-10FFORX90M	7104-24455	1/2	12.7	1-14	20.6	30.0	1.85	47.0	3.67	93.2	2.19	55.7	1
10G-10FFORX90M	7104-24555	5/8	15.9	1-14	23.8	30.0	1.85	47.0	3.65	92.8	2.18	55.3	1
16G-16FFORX90M	7104-24755	1	25.4	1 7/16-12	34.9	41.0	2.80	71.0	5.08	129.9	2.88	73.1	1
16G-20FFORX90M	7104-24915	1	25.4	1 11/16-12	38.1	41.0	3.07	78.0	6.14	156.0	3.91	99.2	1
20G-20FFORX90M	7104-24805	1 1/4	31.7	1 11/16-12	44.5	50.0	3.07	78.0	5.51	140.0	3.19	81.0	1
BULK PACK													
4G-4FFORX90MXBULK	7104-2405	1/4	6.4	9/16-18	12.7	17.0	1.26	32.0	2.21	56.2	1.90	30.2	125
4G-6FFORX90MXBULK	7104-2410	1/4	6.4	11/16-16	12.7	22.0	1.50	38.0	2.50	63.4	1.47	37.4	150
6G-6FFORX90MXBULK	7104-2425	3/8	9.5	11/16-16	15.9	22.0	1.50	38.0	2.50	63.6	1.41	35.7	175
6G-8FFORX90MXBULK	7104-2430	3/8	9.5	13/16-16	15.9	22.0	1.61	41.0	2.70	68.5	1.60	40.6	100
8G-8FFORX90MXBULK	7104-2440	1/2	12.7	13/16-16	—	24.0	1.61	41.0	3.30	83.9	1.83	46.5	100
8G-10FFORX90MXBULK	7104-2445	1/2	12.7	1-14	20.6	30.0	1.85	47.0	3.67	93.2	2.19	55.7	75
10G-10FFORX90MXBULK	7104-2455	5/8	15.9	1-14	23.8	30.0	1.85	47.0	3.65	92.8	2.18	55.3	75
12G-12FFORX90MXBULK	7104-2465	3/4	19.1	1 3/16-12	27.0	36.0	2.28	58.0	4.29	109.0	2.28	58.0	20
16G-16FFORX90MXBULK	7104-2475	1	25.4	1 7/16-12	34.9	41.0	2.80	71.0	5.08	129.9	2.88	73.1	25

- EQUIPMENT
- HOSE/CPLG. SELECTION
- GLOBAL SPIRAL COUPLINGS
- PCM/PCS FERRULES
- MEGACRIMP COUPLINGS**
- POWER CRIMP COUPLINGS
- LOW PRESSURE COUPLINGS
- POLARSEAL COUPLINGS
- C14 COUPLINGS
- PCTS THERMO-PLASTIC COUPLINGS
- FIELD ATTACHABLE G1 & G2 COUPLINGS
- FIELD ATTACHABLE C5 COUPLINGS
- SURELOK AIR BRAKE COUPLINGS
- QUICK DISCONNECT COUPLERS
- NEW BALL VALVES
- ACCESSORIES
- EQUIPMENT AND PARTS



MegaCrimp® Couplings

Female Flat-Face O-Ring Swivel Metric Hex - 90° Long Bent Tube

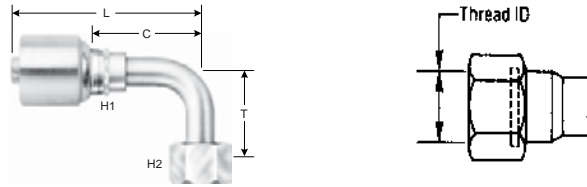

Descr.	Prod. No.	⌀		🌀	H1	H2	T		L		C		Std. Pack
		"	mm		mm	mm	"	mm	"	mm	"	mm	
STANDARD PACK													
4G-4FFORX90L	7104-24065	1/4	6.4	9/16-18	12.7	17.0	1.81	46.0	2.21	56.2	1.19	30.2	1
4G-6FFORX90L	7104-24115	1/4	6.4	11/16-16	12.7	22.0	2.13	54.0	2.43	61.6	1.40	35.6	1
4G-8FFORX90L	7104-24165	1/4	6.4	13/16-16	—	22.0	2.52	64.0	2.64	67.1	1.62	41.1	1
6G-6FFORX90L	7104-24265	3/8	9.5	11/16-16	15.9	22.0	2.13	54.0	2.73	69.3	1.63	41.4	1
6G-8FFORX90L	7104-24315	3/8	9.5	13/16-16	15.9	22.0	2.52	64.0	2.72	69.0	1.62	41.1	1
8G-6FFORX90L	7104-24365	1/2	12.7	11/16-16	20.6	22.0	2.12	54.0	3.15	80.3	1.62	41.4	1
8G-8FFORX90L	7104-24415	1/2	12.7	13/16-16	—	24.0	2.52	64.0	3.30	83.9	1.83	46.5	1
8G-10FFORX90L	7104-24465	1/2	12.7	1-14	20.6	30.0	2.76	70.0	3.57	90.6	2.09	53.1	1
10G-8FFORX90L	7104-24515	5/8	15.9	13/16-16	23.8	24.0	2.52	64.0	3.64	92.4	2.16	54.9	1
10G-10FFORX90L	7104-24565	5/8	15.9	1-14	23.8	30.0	2.76	70.0	3.55	90.2	2.07	52.7	1
12G-12FFORX90L	7104-24665	3/4	19.1	1 3/16-12	27.0	36.0	3.78	96.0	4.65	118.2	2.64	67.2	1
16G-16FFORX90L	7104-24765	1	25.4	1 7/16-12	34.9	41.0	4.49	114.0	5.08	129.9	2.88	73.1	1
20G-20FFORX90L	7104-24815	1 1/4	31.7	1 11/16-12	44.5	50.0	5.08	129.0	5.51	140.0	3.19	81.0	1
BULK PACK													
4G-4FFORX90LXBULK	7104-2406	1/4	6.4	9/16-18	12.7	17.0	1.81	46.0	2.21	56.2	1.19	30.2	120
4G-6FFORX90LXBULK	7104-2411	1/4	6.4	11/16-16	12.7	22.0	2.13	54.0	2.43	61.6	1.40	35.6	75
4G-8FFORX90LXBULK	7104-2416	1/4	6.4	13/16-16	—	22.0	2.52	64.0	2.64	67.1	1.62	41.1	75
6G-6FFORX90LXBULK	7104-2426	3/8	9.5	11/16-16	15.9	22.0	2.13	54.0	2.73	69.3	1.63	41.4	175
6G-8FFORX90LXBULK	7104-2431	3/8	9.5	13/16-16	15.9	22.0	2.52	64.0	2.72	69.0	1.62	41.1	100
8G-8FFORX90LXBULK	7104-2441	1/2	12.7	13/16-16	—	24.0	2.52	64.0	3.30	83.9	1.83	46.5	90
8G-10FFORX90LXBULK	7104-2446	1/2	12.7	1-14	20.6	30.0	2.76	70.0	3.57	90.6	2.09	53.1	50
10G-10FFORX90LXBULK	7104-2456	5/8	15.9	1-14	23.8	30.0	2.76	70.0	3.55	90.2	2.07	52.7	50
12G-12FFORX90LXBULK	7104-2466	3/4	19.1	1 3/16-12	27.0	36.0	3.78	96.0	4.65	118.2	2.64	67.2	40
16G-16FFORX90LXBULK	7104-2476	1	25.4	1 7/16-12	34.9	41.0	4.49	114.0	5.08	129.9	2.88	73.1	25

Female Flat-Face O-Ring Swivel English Hex

SAE J1453 O-Ring Face Seal.

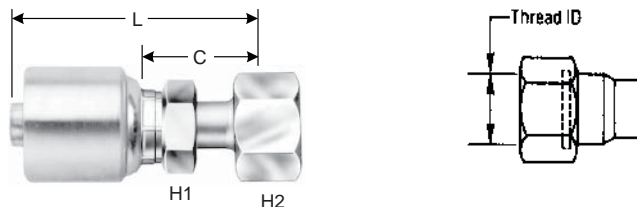

Descr.	Prod. No.	⌀		🌀	H1	H2	L		C		Std. Pack
		"	mm		"	"	"	mm	"	mm	
STANDARD PACK											
4GE-4FFORX	7102-13125	1/4	6.4	9/16-18	9/16	11/16	2.15	54.5	1.12	28.5	5
4GE-6FFORX	7102-13135	1/4	6.4	11/16-16	5/8	13/16	2.24	57.0	1.22	31.0	1





Female Flat-Face O-Ring Swivel English Hex - cont'd

Descr.	Prod. No.	⊖			H1	H2	L		C		Std. Pack
		"	mm				"	mm	"	mm	
5GE-6FFORX	7102-04015	5/16	7.9	11/16-16	5/8	13/16	2.70	68.5	1.22	31.0	1
6GE-4FFORX	7102-13195	3/8	9.5	9/16-18	21/32	11/16	2.24	57.0	1.15	29.1	1
6GE-6FFORX	7102-13145	3/8	9.5	11/16-16	5/8	13/16	2.32	59.0	1.22	31.0	5
6GE-8FFORX	7102-13155	3/8	9.5	13/16-16	3/4	15/16	2.52	64.0	1.42	36.1	5
8GE-6FFORX	7102-04045	1/2	12.7	11/16-16	13/16	13/16	2.74	69.5	1.26	32.0	1
8GE-8FFORX	7102-03165	1/2	12.7	13/16-16	13/16	15/16	2.89	73.5	1.42	36.0	5
8GE-10FFORX	7102-03175	1/2	12.7	1-14	15/16	1 1/8	3.19	81.0	1.71	43.5	1
8GE-12FFORX	7102-04005	1/2	9.5	1 3/16-12	15/16	1 3/8	3.32	84.3	1.84	46.8	1
10GE-8FFORX	7102-04175	5/8	15.8	16/16-16	15/16	1 3/8	3.30	83.7	1.80	46.0	1
10GE-10FFORX	7102-03185	5/8	15.8	1-14	1	1 1/8	3.21	81.5	1.73	44.0	1
10GE-12FFORX	7102-03195	5/8	15.8	1 3/16-12	15/16	1 3/8	3.31	84.0	1.83	46.5	1
12GE-10FFORX	7102-03205	3/4	19.0	1-14	1 1/16	1 1/8	3.76	95.5	1.75	44.5	1
12GE-12FFORX	7102-03905	3/4	19.0	1 3/16-12	1 1/16	1 3/8	3.78	96.0	1.77	45.0	1
12GE-16FFORX	7102-03915	3/4	19.0	1 7/16-12	1 1/8	1 5/8	3.99	101.4	1.98	50.4	1
16GE-12FFORX	7102-13185	1	25.4	1 3/16-12	1 3/8	1 3/8	4.17	106.0	1.94	49.2	1
16GE-16FFORX	7102-03925	1	25.4	1 7/16-12	1 3/8	1 5/8	4.46	113.4	2.23	56.6	1
16GE-20FFORX	7102-03935	1	25.4	1 11/16-12	1 3/8	1 5/8	4.46	113.4	2.23	56.6	1
20GE-20FFORX	7102-03945	1 1/4	31.7	1 11/16-12	1 3/4	1 7/8	4.50	114.4	2.18	55.4	1
BULK PACK											
4GE-4FFORX XBULK	7102-1312	1/4	6.4	9/16-18	9/16	11/16	2.15	54.5	1.12	28.5	280
4GE-6FFORX XBULK	7102-1313	1/4	6.4	11/16-16	5/8	13/16	2.24	57.0	1.22	31.0	235
6GE-6FFORX XBULK	7102-1314	3/8	9.5	11/16-16	5/8	13/16	2.32	59.0	1.22	31.0	200
6GE-8FFORX XBULK	7102-1315	3/5	9.5	13/16-16	3/4	15/16	2.52	64.0	1.42	36.1	160
8GE-6FFORX XBULK	7102-0404	1/2	12.7	11/16-16	13/16	13/16	2.74	69.5	1.26	32.0	100
8GE-8FFORX XBULK	7102-0316	1/2	12.7	13/16-16	13/16	15/16	2.89	73.5	1.42	36.0	125
8GE-10FFORX XBULK	7102-0317	1/2	12.7	1-14	15/16	1 1/8	3.19	81.0	1.71	43.5	90
8GE-12FFORX XBULK	7102-0400	1/2	9.5	1 3/16-12	15/16	1 3/8	3.32	84.3	1.84	46.8	60
10GE-10FFORX XBULK	7102-0318	5/8	15.8	1-14	1	1 1/8	3.21	81.5	1.73	44.0	100
10GE-12FFORX XBULK	7102-0319	5/8	15.8	1 3/16-12	15/16	1 3/8	3.31	84.0	1.83	46.5	65
12GE-10FFORX XBULK	7102-0320	3/4	19.0	1-14	1 1/16	1 1/8	3.76	95.5	1.75	44.5	75
12GE-12FFORX XBULK	7102-0390	3/4	19.0	1 3/16-12	1 1/16	1 3/8	3.78	96.0	1.77	45.0	50
12GE-16FFORX XBULK	7102-0391	3/4	19.0	1 7/16-12	1 1/8	1 5/8	3.99	101.4	1.98	50.4	45
16GE-16FFORX XBULK	7102-0392	1	25.4	1 7/16-12	1 3/8	1 5/8	4.46	113.4	2.23	56.6	25
16GE-20FFORX XBULK	7102-0393	1	25.4	1 11/16-12	1 3/8	1 5/8	4.46	113.4	2.23	56.6	25
20GE-20FFORX XBULK	7102-0394	1 1/4	31.7	1 11/16-12	1 3/4	1 7/8	4.50	114.4	2.18	55.4	20

EQUIPMENT

HOSE/CPLG. SELECTION

GLOBAL SPIRAL COUPLINGS

PCM/PCS FERRULES

MEGACRIMP COUPLINGS

POWER CRIMP COUPLINGS

LOW PRESSURE COUPLINGS

POLARSEAL COUPLINGS

C14 COUPLINGS

PCTS THERMO-PLASTIC COUPLINGS

FIELD ATTACHABLE G1 & G2 COUPLINGS

FIELD ATTACHABLE C5 COUPLINGS

SURELOK AIR BRAKE COUPLINGS

QUICK DISCONNECT COUPLERS

NEW BALL VALVES

ACCESSORIES

EQUIPMENT AND PARTS





MegaCrimp® Couplings

Female Flat-Face O-Ring Swivel - 45° Bent Tube English Hex

SAE J1453 O-Ring Face Seal.

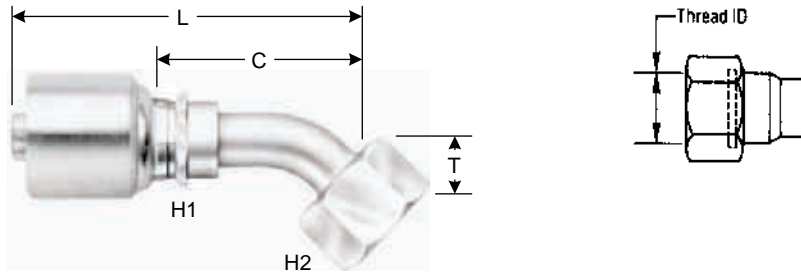

Descr.	Prod. No.	Ø			H1	H2	T		L		C		Std. Pack
		"	mm		"	"	"	mm	"	mm	"	mm	
STANDARD PACK													
4GE-4FFORX45	7102-13265	1/4	6.4	9/16-18	1/2	11/16	.41	10.4	2.56	65.0	1.54	39.0	1
5GE-6FFORX45	7102-04025	5/16	7.9	11/16-16	5/8	13/16	.43	10.9	2.73	69.3	1.63	41.3	1
6GE-8FFORX45	7102-13295	3/8	9.5	13/16-16	5/8	15/16	.59	15.0	3.07	78.0	1.97	50.1	1
8GE-10FFORX45	7102-03315	1/2	12.7	13/16-16	13/16	1 1/8	.65	16.5	3.52	89.5	2.05	52.1	1
8GE-12FFORX45	7102-03765	1/2	12.7	13/16-12	15/16	1 3/8	.83	21.0	4.34	110.3	2.87	72.9	1
10GE-12FFORX45	7102-03335	5/8	15.8	1 3/16-12	15/16	1 3/8	.83	21.1	3.90	99.1	2.42	61.5	1
12GE-10FFORX45	7102-04165	3/4	19.0	1-14	1 1/16	1 1/8	.65	16.5	4.00	101.6	1.99	50.6	1
12GE-12FFORX45	7102-03345	3/4	19.0	13/16-12	1 1/16	1 3/8	.83	21.1	4.67	118.5	2.66	67.5	1
12GE-16FFORX45	7102-03355	3/4	19.0	1 7/16-12	1 3/16	1 5/8	.94	23.9	5.24	133.0	3.23	82.0	1
16GE-16FFORX45	7102-03845	1	25.4	1 7/16-12	1 3/8	1 5/8	.94	23.9	5.08	129.1	2.85	72.3	1
20GE-20FFORX45	7102-03375	1 1/4	31.7	1 11/16-12	1 3/4	1 7/8	1.00	25.4	5.83	148.0	3.50	89.0	1
BULK PACK													
4GE-4FFORX45XBULK	7102-1326	1/4	6.4	9/16-18	1/2	11/16	.41	10.4	2.56	65.0	1.54	39.0	20
4GE-6FFORX45XBULK	7102-1327	3/8	6.4	9/16-18	1/2	13/16	.43	10.9	2.70	68.5	1.67	42.5	240
6GE-6FFORX45XBULK	7102-1328	3/8	9.5	11/16-16	5/8	1 7/8	.43	10.9	2.75	69.8	1.65	41.9	190
6GE-8FFORX45XBULK	7102-1329	3/8	9.5	13/16-16	5/8	15/16	.59	15.0	3.07	78.0	1.97	50.1	125
8GE-10FFORX45 XBULK	7102-0331	1/2	12.7	13/16-16	13/16	1 1/8	.65	16.5	3.52	89.5	2.05	52.1	50
10GE-10FFORX45XBULK	7102-0332	5/8	15.8	1-14	15/16	15/16	.65	16.5	3.50	89.0	2.03	51.6	85
10GE-12FFORX45XBULK	7102-0333	5/8	15.8	1 3/16-12	15/16	1 3/8	.83	21.1	3.90	99.1	2.42	61.5	50
12GE-12FFORX45XBULK	7102-0334	3/4	19.0	1 3/16-12	1 1/16	1 3/8	.83	21.1	4.67	118.5	2.66	67.5	50
12GE-16FFORX45XBULK	7102-0335	3/4	19.0	1 7/16-12	1 3/16	1 5/8	.94	23.9	5.24	133.0	3.23	82.0	35
16GE-16FFORX45XBULK	7102-0384	1	25.4	1 7/16-12	1 3/8	1 5/8	.94	23.9	5.08	129.1	2.85	72.3	25
20GE-20FFORX45 XBULK	7102-0337	1 1/4	31.7	1 11/16-12	1 3/4	1 7/8	1.00	25.4	5.83	148.0	3.50	89.0	25

EQUIPMENT
HOSE/CPLG. SELECTION
GLOBALSPIRAL COUPLINGS
PCM/PCS FERRULES
MEGACRIMP COUPLINGS
POWER CRIMP COUPLINGS
LOW PRESSURE COUPLINGS
POLARSEAL COUPLINGS
C14 COUPLINGS
PCTS THERMO-PLASTIC COUPLINGS
FIELD ATTACHABLE G1 & G2 COUPLINGS
FIELD ATTACHABLE C5 COUPLINGS
SURELOK AIR BRAKE COUPLINGS
QUICK DISCONNECT COUPLERS
NEW BALL VALVES
ACCESSORIES
EQUIPMENT AND PARTS





Female Flat-Face O-Ring Swivel - 45° Short Bent Tube English Hex

SAE J1453 O-Ring Face Seal.

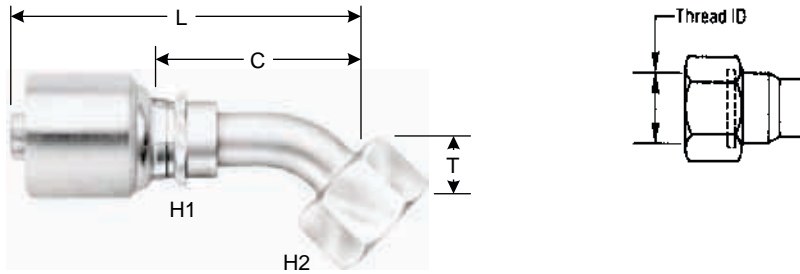

Descr.	Prod. No.	⊖			H1	H2	T		L		C		Std. Pack
		"	mm		"	"	"	mm	"	mm	"	mm	
STANDARD PACK													
6GE-4FFORX45S	7102-03985	3/8	9.5	9/16-18	5/8	11/16	.39	10.0	2.60	66.1	1.50	38.1	1
8GE-8FFORX45	7102-04325	1/2	12.7	13/16-16	13/16	15/16	.59	15.0	3.50	89.0	2.03	51.5	1
BULK PACK													
8GE-8FFORX45XBULK	7102-0432	1/2	12.7	13/16-16	13/16	15/16	.59	15.0	3.50	89.0	2.03	51.5	100

Female Flat-Face O-Ring Swivel - 67½° Bent Tube English Hex

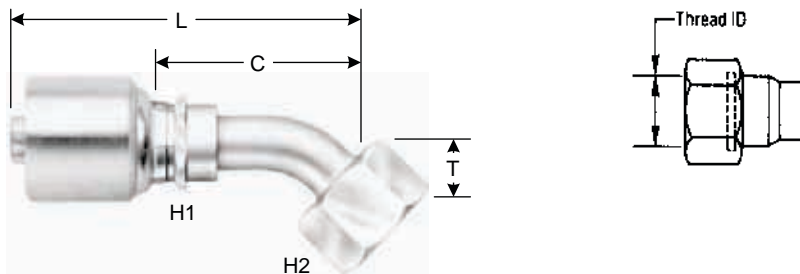

Descr.	Prod. No.	⊖			H1	H2	T		L		C		Std. Pack
		"	mm		"	"	"	mm	"	mm	"	mm	
STANDARD PACK													
8GE-8FFORX67-022	7102-03775	1/2	12.7	13/16-16	13/16	15/16	.59	15.0	3.50	89.0	2.03	51.5	1

EQUIPMENT

HOSE/CPLG. SELECTION

GLOBALSPIRAL COUPLINGS

PCM/PCS FERRULES

MEGACRIMP COUPLINGS

POWER CRIMP COUPLINGS

LOW PRESSURE COUPLINGS

POLARSEAL COUPLINGS

C14 COUPLINGS

PCTS THERMO-PLASTIC COUPLINGS

FIELD ATTACHABLE G1 & G2 COUPLINGS

FIELD ATTACHABLE C5 COUPLINGS

SURELOK AIR BRAKE COUPLINGS

QUICK DISCONNECT COUPLERS

NEW BALL VALVES

ACCESSORIES

EQUIPMENT AND PARTS



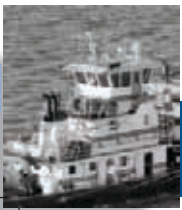



MegaCrimp® Couplings

Female Flat-Face O-Ring Swivel - 90° Short Bent Tube English Hex

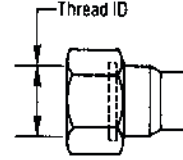
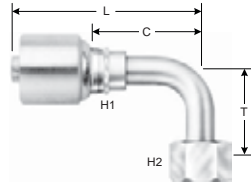
SAE J1453 O-Ring Face Seal.



DESCR.	PROD. NO.	Ø			H1	H2	T		L		C		Std. Pack
		"	mm		"	"	"	mm	"	mm	"	mm	
STANDARD PACK													
4GE-4FFORX90S	7102-13385	1/4	6.4	9/16-18	1/2	11/16	.82	20.8	2.38	60.4	1.35	34.4	1
4GE-6FFORX90S	7102-13415	1/4	6.4	11/16-16	1/2	13/16	.90	22.9	2.50	63.4	1.47	37.3	1
5GE-6FFORX90S	7102-04035	5/16	7.9	11/16-18	5/8	13/16	.90	22.9	2.84	72.1	1.74	44.1	1
6GE-4FFORX90S	7102-04105	3/8	9.5	9/16-18	5/8	11/16	.82	20.8	2.42	61.4	1.32	33.5	1
6GE-6FFORX90S	7102-13455	3/8	9.5	11/16-16	5/8	13/16	.90	22.9	2.55	64.7	1.44	36.7	1
6GE-8FFORX90S	7102-13485	3/8	9.5	13/16-16	5/8	15/16	1.15	29.2	2.87	73.0	1.77	45.0	1
8GE-6FFORX90S	7102-04125	1/2	12.7	11/16-16	13/16	13/16	.90	22.9	2.98	75.7	1.50	38.2	1
8GE-8FFORX90S	7102-04335	1/2	12.7	13/16-16	13/16	15/16	1.15	29.2	3.30	83.9	1.83	46.4	1
8GE-12FFORX90S	7102-04135	1/2	12.7	1 3/16-12	15/16	1 3/8	1.83	46.6	4.06	103.1	2.58	65.6	1
10GE-10FFORX90S	7102-03575	5/8	15.8	1-14	15/16	1 1/8	1.27	32.3	3.28	83.4	1.81	45.9	1
10GE-12FFORX90S	7102-03605	5/8	15.8	1 3/16-12	15/16	1 3/8	1.88	47.8	3.80	96.6	2.33	59.1	1
12GE-10FFORX90S	7102-03745	3/4	19.0	1-14	1 1/16	1 1/8	1.26	32.0	4.13	105.0	2.13	54.0	1
12GE-12FFORX90S	7102-03615	3/4	19.0	1 3/16-12	1 1/16	1 3/8	1.88	47.8	4.26	108.2	2.25	57.2	1
12GE-16FFORX90S	7102-03645	3/4	19.0	1 7/16-12	1 3/16	1 3/8	2.21	56.1	4.67	118.5	2.66	67.5	1
16GE-12FFORX90S	7102-03755	1	25.4	1 3/16-12	1 3/8	1 3/8	1.89	48.0	4.83	122.8	2.60	66.0	1
16GE-16FFORX90S	7102-03655	1	25.4	1 7/16-12	1 3/8	1 5/8	2.21	56.1	5.11	129.9	2.88	73.1	1
20GE-20FFORX90S	7102-03685	1 1/4	31.7	1 11/16-12	1 3/4	1 7/8	2.51	63.8	5.51	140.0	3.19	81.0	1
BULK PACK													
4GE-4FFORX90SXBULK	7102-1338	1/4	6.4	9/16-18	1/2	11/16	.82	20.8	2.38	60.4	1.35	34.4	255
4GE-6FFORX90SXBULK	7102-1341	1/4	6.4	11/16-16	1/2	13/16	.90	22.9	2.50	63.4	1.47	37.3	225
6GE-6FFORX90SXBULK	7102-1345	3/8	9.5	11/16-16	5/8	13/16	.90	22.9	2.55	64.7	1.44	36.7	185
6GE-8FFORX90SXBULK	7102-1348	3/8	9.5	13/16-16	5/8	15/16	1.15	29.2	2.87	73.0	1.77	45.0	125
8GE-8FFORX90SXBULK	7102-0433	1/2	12.7	13/16-16	13/16	15/16	1.15	29.2	3.30	83.9	1.83	46.4	110
8GE-10FFORX90SXBULK	7102-0354	1/2	12.7	1-14	13/16	1 1/8	1.27	32.3	3.30	83.8	1.82	46.3	100
10GE-10FFORX90SXBULK	7102-0357	5/8	15.8	1-14	15/16	1 1/8	1.27	32.3	3.28	83.4	1.81	45.9	80
10GE-12FFORX90SXBULK	7102-0360	5/8	15.8	1 3/16-12	15/16	1 3/8	1.88	47.8	3.80	96.6	2.33	59.1	50
12GE-12FFORX90SXBULK	7102-0361	3/4	19.0	1 3/16-12	1 1/16	1 3/8	1.88	47.8	4.26	108.2	2.25	57.2	45
12GE-16FFORX90SXBULK	7102-0364	3/4	19.0	1 7/16-12	1 3/16	1 3/8	2.21	56.1	4.67	118.5	2.66	67.5	30
16GE-16FFORX90SXBULK	7102-0365	1	25.4	1 7/16-12	1 3/8	1 5/8	2.21	56.1	5.11	129.9	2.88	73.1	25
20GE-20FFORX90SXBULK	7102-0368	1 1/4	31.7	1 11/16-12	1 3/4	1 7/8	2.51	63.8	5.51	140.0	3.19	81.0	15





Female Flat-Face O-Ring Swivel - 90° Medium Bent Tube English Hex

SAE J1453 O-Ring Face Seal.

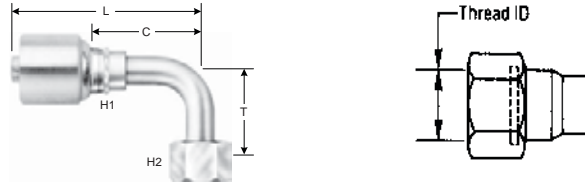

Descr.	Prod. No.	⊖			H1	H2	T		L		C		Std. Pack
		"	mm				"	mm	"	mm	"	mm	
STANDARD PACK													
4GE-4FFORX90M	7102-13395	1/4	6.4	9/16-18	1/2	11/16	1.26	32.0	2.17	55.2	1.15	29.2	1
4GE-6FFORX90M	7102-13375	1/4	6.4	11/16-16	1/2	13/16	1.51	38.4	2.30	58.5	1.28	32.5	1
4GE-8FFORX90M	7102-13445	1/4	6.4	13/16-16	5/8	15/16	2.51	63.8	2.60	66.0	1.57	40.0	1
6GE-6FFORX90M	7102-13465	3/8	9.5	11/16-16	5/8	13/16	1.51	38.4	2.55	64.7	1.45	36.8	1
8GE-8FFORX90M	7102-04345	1/2	12.7	13/16-16	13/16	15/16	1.62	41.2	3.19	80.9	1.71	43.4	1
8GE-10FFORX90M	7102-03555	1/2	12.7	1-14	13/16	1 1/8	1.85	47.0	3.06	77.7	1.58	40.2	1
10GE-10FFORX90M	7102-03585	5/8	15.8	1-14	15/16	1 1/8	1.85	47.0	3.06	77.6	1.58	40.2	1
12GE-12FFORX90M	7102-03625	3/4	19.0	1 3/16-12	1 1/16	1 3/8	2.28	57.9	4.20	106.8	2.20	55.8	1
16GE-16FFORX90M	7102-03855	1	25.4	1 7/16-12	1 3/8	1 5/8	2.78	70.6	4.53	115.0	2.29	58.2	1
20GE-20FFORX90M	7102-03695	1 1/4	31.7	1 11/16-12	1 3/4	1 7/8	3.09	78.5	5.31	135.0	2.99	76.0	1
BULK PACK													
4GE-6FFORX90MXBULK	7102-1337	1/4	6.4	11/16-16	1/2	13/16	1.51	38.4	2.30	58.5	1.28	32.5	150
6GE-6FFORX90MXBULK	7102-1346	3/8	9.5	11/16-16	5/8	13/16	1.51	38.4	2.55	64.7	1.45	36.8	175
6GE-8FFORX90MXBULK	7102-1349	3/8	9.5	1-14	5/8	15/16	1.62	41.2	2.70	68.5	1.59	40.5	100
8GE-8FFORX90MXBULK	7102-0434	1/2	12.7	13/16-16	13/16	15/16	1.62	41.2	3.19	80.9	1.71	43.4	100
8GE-10FFORX90MXBULK	7102-0355	1/2	12.7	1-14	13/16	1 1/8	1.85	47.0	3.06	77.7	1.58	40.2	75
10GE-10FFORX90MXBULK	7102-0358	5/8	15.8	1-14	15/16	1 1/8	1.85	47.0	3.06	77.6	1.58	40.2	75
12GE-12FFORX90MXBULK	7102-0362	3/4	19.0	1 3/16-12	1 1/16	1 3/8	2.28	57.9	4.20	106.8	2.20	55.8	20

Female Flat-Face O-Ring Swivel - 90° Long Bent Tube English Hex

SAE J1453 O-Ring Face Seal.

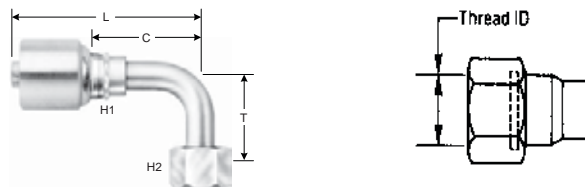

Descr.	Prod. No.	⊖			H1	H2	T		L		C		Std. Pack
		"	mm				"	mm	"	mm	"	mm	
STANDARD PACK													
4GE-4FFORX90L	7102-13405	1/4	6.4	9/16-18	1/2	11/16	1.80	45.7	2.17	55.2	1.15	29.2	1
4GE-6FFORX90L	7102-13435	1/4	6.4	11/16-16	1/2	13/16	2.13	54.1	2.30	58.5	1.28	32.5	1
6GE-6FFORX90L	7102-13475	3/8	9.5	11/16-16	5/8	1	2.13	54.1	2.48	62.9	1.38	35.0	1
6GE-8FFORX90L	7102-13505	3/8	9.5	13/16-16	5/8	15/16	2.51	63.8	2.72	69.0	1.61	41.0	1
8GE-8FFORX90L	7102-04355	1/2	6.4	13/16-16	1/2	11/16	1.80	45.7	2.17	55.2	1.15	29.2	1
8GE-10FFORX90L	7102-03565	1/2	12.7	1-14	13/16	1 1/8	2.76	70.1	3.07	77.9	1.59	40.4	1

EQUIPMENT

HOSE/CPLG. SELECTION

GLOBAL SPIRAL COUPLINGS

PCM/PCS FERRULES

MEGACRIMP COUPLINGS

POWER CRIMP COUPLINGS

LOW PRESSURE COUPLINGS

POLARSEAL COUPLINGS

C14 COUPLINGS

PCTS THERMO-PLASTIC COUPLINGS

FIELD ATTACHABLE G1 & G2 COUPLINGS

FIELD ATTACHABLE C5 COUPLINGS

SURELOK AIR BRAKE COUPLINGS

QUICK DISCONNECT COUPLERS



NEW BALL VALVES

ACCESSORIES

EQUIPMENT AND PARTS



Female Flat-Face O-Ring Swivel - 90° Long Bent Tube English Hex - Cont'd

Descr.	Prod. No.	⊖				H1		H2		T		L		C		Std. Pack
		"	mm			"	"	"	mm	"	mm	"	mm			
10GE-10FFORX90L	7102-03595	5/8	15.8	1-14	15/16	1 1/8	2.76	70.1	3.05	77.5	1.57	40.0	1			
12GE-12FFORX90L	7102-03835	3/4	19.0	1 13/16-12	1 1/16	1 3/8	3.78	96.0	4.02	102.0	2.01	51.0	1			
16GE-16FFORX90L	7102-03675	1	25.4	1 7/16-12	1 3/8	1 5/8	4.50	114.3	4.53	115.0	2.29	58.2	1			
BULK PACK																
4GE-4FFORX90LXBULK	7102-1340	1/4	6.4	9/16-18	1/2	11/16	1.80	45.7	2.17	55.2	1.15	29.2	120			
4GE-6FFORX90LXBULK	7102-1343	1/4	6.4	11/16-16	1/2	13/16	2.13	54.1	2.30	58.5	1.28	32.5	75			
6GE-6FFORX90LXBULK	7102-1347	3/8	9.5	11/16-16	5/8	1	2.13	54.1	2.48	62.9	1.38	35.0	175			
6GE-8FFORX90LXBULK	7102-1350	3/8	9.5	13/16-16	5/8	15/16	2.51	63.8	2.72	69.0	1.61	41.0	100			
8GE-8FFORX90LXBULK	7102-0435	1/2	6.4	13/16-16	1/2	11/16	1.80	45.7	2.17	55.2	1.15	29.2	90			
8GE-10FFORX90LXBULK	7102-0356	1/2	12.7	1-14	13/16	1 1/8	2.76	70.1	3.07	77.9	1.59	40.4	50			
10GE-10FFORX90LXBULK	7102-0359	5/8	15.8	1-14	15/16	1 1/8	2.76	70.1	3.05	77.5	1.57	40.0	50			
12GE-12FFORX90LXBULK	7102-0383	3/4	19.0	1 3/16-12	1 1/16	1 3/8	3.78	96.0	4.02	102.0	2.01	51.0	40			
16GE-16FFORX90LXBULK	7102-0367	1	25.4	1 7/16-12	1 3/8	1 5/8	4.50	114.3	4.53	115.0	2.29	58.2	25			

Code 61 O-Ring Flange

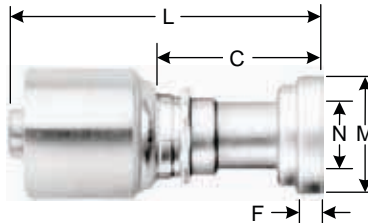

Descr.	Prod. No.	⊖		N	M	L	C	F	Std. Pack				
		"	mm										
STANDARD PACK													
8G-8FL	7103-25055	1/2	12.7	1/2	1.19	30.2	3.15	80.0	1.67	42.5	.27	6.7	1
8G-12FL	7103-25105	1/2	12.7	3/4	1.50	38.1	3.15	80.0	1.67	42.5	.27	6.7	1
12G-12FL	7103-25205	3/4	19.0	3/4	1.50	38.1	3.86	98.0	1.85	47.0	.27	6.7	1
12G-16FL	7103-25255	3/4	19.0	1	1.75	44.5	3.50	88.8	1.49	37.8	.32	8.0	1
16G-12FL	7103-25295	1	25.4	3/4	1.50	38.1	5.04	128.0	2.80	71.2	.27	6.7	1
16G-16FL	7103-25305	1	25.4	1	1.75	44.5	4.13	105.0	1.90	48.2	.32	8.0	1
16G-20FL	7103-25355	1	25.4	1 1/4	2.00	50.8	4.13	105.0	1.90	48.2	.32	8.0	1
16G-24FL	7100-03875	1	25.4	1 1/2	2.38	60.5	3.76	95.8	1.53	39.1	.32	8.0	1
20G-20FL	7103-25405	1 1/4	31.7	1 1/4	2.00	50.8	4.43	112.5	2.11	53.5	.32	8.0	1
20G-24FL	7103-25455	1 1/4	31.7	1 1/2	2.38	60.5	4.63	117.5	2.30	58.5	.32	8.0	1
BULK PACK													
12G-12FLXBULK	7103-2520	3/4	19.0	3/4	1.50	38.1	3.86	98.0	1.85	47.0	.27	6.7	50
12G-16FLXBULK	7103-2525	3/4	19.0	1	1.75	44.5	3.50	88.8	1.49	37.8	.32	8.0	50
16G-16FLXBULK	7103-2530	1	25.4	1	1.75	44.5	4.13	105.0	1.90	48.2	.32	8.0	35
16G-20FLXBULK	7103-2535	1	25.4	1 1/4	2.00	50.8	4.13	105.0	1.90	48.2	.32	8.0	30
20G-20FLXBULK	7103-2540	1 1/4	31.7	1 1/4	2.00	50.8	4.43	112.5	2.11	53.5	.32	8.0	20
20G-24FLXBULK	7103-2545	1 1/4	31.7	1 1/2	2.38	60.5	4.63	117.5	2.30	58.5	.32	8.0	20



Code 61 O-Ring Flange - 22½° Bent Tube

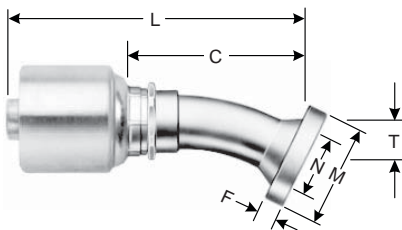

Descr.	Prod. No.	⊖		N		M		T		L		C		F		Std. Pack
		"	mm	"	"	mm	"	mm	"	mm	"	mm	"	mm		
STANDARD PACK																
12G-12FL22M	7103-26155	3/4	19.0	3/4	1.50	38.1	.44	11.2	4.47	113.5	2.46	62.5	.27	6.9	1	
12G-16FL22M-014	7100-03955	3/4	19.0	1	1.75	44.5	.55	14.0	4.76	121.0	2.76	70.0	.32	8.0	1	
16G-16FL22M	7103-26255	1	25.4	1 7/16-12	1.75	44.5	.44	11.2	4.84	123.0	2.61	66.2	.32	8.0	1	
20G-20FL22M	7103-26355	1 1/4	31.7	1 11/16-12	2.00	50.8	.50	12.7	5.18	131.5	2.85	72.5	.32	8.0	1	

Code 61 O-Ring Flange - 30° Bent Tube

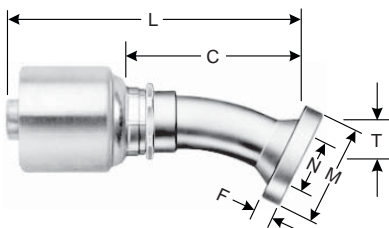

Descr.	Prod. No.	⊖		N		M		T		L		C		F		Std. Pack
		"	mm	"	"	mm	"	mm	"	mm	"	mm	"	mm		
STANDARD PACK																
12G-12FL30M	7103-26655	3/4	19.0	3/4	1.50	38.1	1.00	25.4	4.67	118.5	2.66	67.5	.32	8.0	1	
12G-16FL30M	7100-04045	3/4	19.0	1	1.75	44.5	.75	19.0	4.88	124.0	2.87	73.0	.32	8.0	1	
16G-16FL30M	7103-26755	1	25.4	1	1.75	44.5	.62	15.7	4.92	125.0	2.69	68.2	.32	8.0	1	
16G-20FL30M	7103-26805	1	25.4	1 1/2	2.00	50.8	.86	21.8	5.87	149.4	3.63	92.5	.32	8.0	1	
20G-20FL30S	7103-26845	1 1/4	31.7	1 1/4	2.00	50.8	.79	20.0	6.03	153.4	3.72	94.4	.32	8.0	1	

EQUIPMENT
HOSE/CPLG. SELECTION
GLOBALSPIRAL COUPLINGS
PCM/PCS FERRULES
MEGACRIMP COUPLINGS
POWER CRIMP COUPLINGS
LOW PRESSURE COUPLINGS
POLARSEAL COUPLINGS
C14 COUPLINGS
PCTS THERMO-PLASTIC COUPLINGS
FIELD ATTACHABLE G1 & G2 COUPLINGS
FIELD ATTACHABLE C5 COUPLINGS
SURELOK AIR BRAKE COUPLINGS
QUICK DISCONNECT COUPLERS
NEW BALL VALVES
ACCESSORIES
EQUIPMENT AND PARTS





MegaCrimp® Couplings

Code 61 O-Ring Flange - 45° Bent Tube

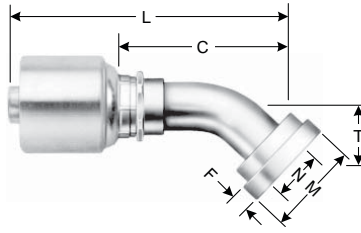

Descr.	Prod. No.	⊖		N	M		T		L		C		F		Std. Pack
		"	mm		"	"	mm	"	mm	"	mm	"	mm	"	
STANDARD PACK															
8G-8FL45	7100-04125	1/2	12.7	1/2	1.19	30.2	.78	19.8	3.70	94.0	2.22	56.5	.26	6.9	1
8G-12FL45M	7103-27165	1/2	12.7	3/4	1.50	38.1	.78	19.8	3.70	94.0	2.22	56.5	.27	6.9	1
12G-12FL45M	7103-27245	3/4	19.0	3/4	1.50	38.1	1.00	25.4	4.67	118.5	2.66	67.5	.27	6.9	1
12G-16FL45S	7103-27315	3/4	19.0	1	1.75	44.4	1.00	25.4	4.67	118.5	2.66	67.5	.32	8.0	1
16G-16FL45S	7103-27395	1	25.4	1	1.75	44.4	1.06	26.9	5.11	129.7	2.87	72.9	.32	8.0	1
16G-20FL45S	7103-27475	1	25.4	1 1/4	2.00	50.8	1.06	26.9	5.10	129.5	2.86	72.7	.32	8.0	1
16G-24FL45	7100-07185	1	25.4	1 1/2	2.38	60.3	1.06	26.9	5.30	134.6	3.05	77.7	.32	8.0	1
20G-20FL45S	7103-27555	1 1/4	31.7	1 1/4	2.00	50.8	1.15	29.2	5.59	142.0	3.27	83.0	.32	8.0	1
BULK PACK															
16G-16FL45SX BULK	7103-2739	1	25.4	1	1.75	44.4	1.06	26.9	5.11	129.7	2.87	72.9	.32	8.0	25

Code 61 O-Ring Flange - 60° Bent Tube

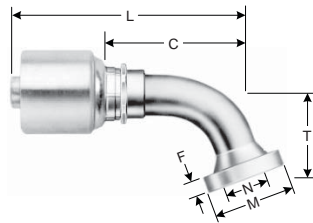

Descr.	Prod. No.	⊖		N	M		T		L		C		F		Std. Pack
		"	mm		"	"	mm	"	mm	"	mm	"	mm		
STANDARD PACK															
12G-12FL60M	7103-28155	3/4	19.0	3/4	1.50	38.1	1.41	35.8	4.61	117.0	2.60	66.0	.27	6.9	1
12G-16FL60M	7103-28205	3/4	19.0	1	1.75	44.5	1.73	44.0	4.80	122.0	2.80	71.0	.32	8.0	1
16G-16FL60M	7103-28255	1	25.4	1	1.75	44.5	1.73	44.0	5.85	148.5	3.61	91.7	.32	8.0	1
20G-20FL60S	7103-28345	1 1/4	31.7	1 1/4	2.00	50.8	1.77	45.0	6.22	158.0	3.90	99.0	.32	8.0	1





Code 61 O-Ring Flange - 67½° Bent Tube

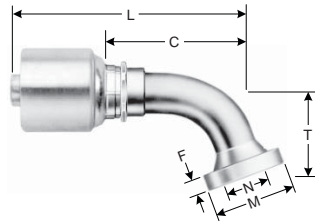

Descr.	Prod. No.	⊖		N		M		T		L		C		F		Std. Pack
		"	mm	"	"	mm	"	mm	"	mm	"	mm	"	mm		
STANDARD PACK																
12G-12FL67M	7100-04355	3/4	19.0	3/4	1.50	38.1	1.65	42.0	4.65	118.0	2.64	67.0	.27	6.9	1	
20G-20FL67S	7100-04335	1 1/4	31.7	1 1/4	2.00	50.8	2.01	51.0	5.92	150.4	3.60	91.4	.32	8.0	1	

Code 61 O-Ring Flange - 90° Bent Tube

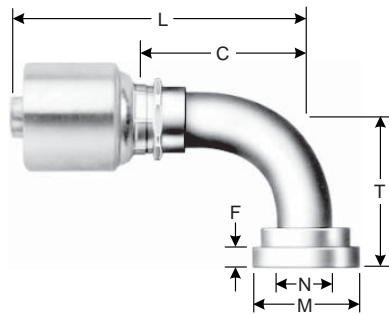

Descr.	Prod. No.	⊖		N		M		T		L		C		F		Std. Pack
		"	mm	"	"	mm	"	mm	"	mm	"	mm	"	mm		
STANDARD PACK																
8G-8FL90M	7103-29115	1/2	12.7	1/2	1.19	30.1	1.63	41.4	3.59	91.2	2.11	53.7	.27	6.9	1	
8G-12FL90M	7103-29235	1/2	12.7	3/4	1.50	38.1	1.63	41.4	3.60	91.5	2.13	54.0	.27	6.9	1	
10G-12FL90M	7100-04485	5/8	15.9	3/4	1.50	38.1	2.28	58.0	3.94	100.0	2.46	62.5	.27	6.9	1	
12G-12FL90M	7103-29535	3/4	19.0	3/4	1.50	38.1	2.13	54.1	4.40	111.7	2.39	60.7	.27	6.7	1	
12G-16FL90S	7103-29585	3/4	19.0	1	1.75	44.4	2.13	54.1	4.40	111.7	2.39	60.7	.32	8.0	1	
16G-12FL90M	7103-29655	1	25.4	3/4	1.50	38.1	1.97	50.0	5.09	129.3	2.85	72.5	.27	6.9	1	
16G-16FL90S	7103-29705	1	25.4	1	1.75	44.4	2.38	60.5	5.04	128.1	2.81	71.3	.32	8.0	1	
16G-20FL90S	7103-29765	1	25.4	1 1/4	2.00	50.8	2.38	60.5	5.04	128.1	2.81	71.3	.32	8.0	1	
16G-24FL90S-081	7100-04555	1	25.4	1/2	2.38	60.5	3.19	81.0	5.57	141.6	3.34	84.8	.32	8.0	1	
20G-20FL90-102	7100-04565	1 1/4	31.7	1 1/4	2.00	50.8	2.62	66.5	5.41	137.5	3.09	78.5	.32	8.0	1	
20G-20FL90M	7103-29895	1 1/4	31.8	1 1/4	2.00	50.8	3.54	89.9	5.30	134.9	2.98	75.9	.32	8.0	1	
20G-20FL90S	7103-29885	1 1/4	31.7	1 1/4	2.00	50.8	3.98	101.0	5.43	138.0	3.11	79.0	.32	8.0	1	
20G-24FL90S	7103-29945	1 1/4	31.7	1 1/2	2.38	60.5	2.62	66.5	5.67	144.0	3.35	85.0	.32	8.0	1	
BULK PACK																
8G-8FL90MXBULK	7103-2911	1/2	12.7	1/2	1.19	30.1	1.63	41.4	3.59	91.2	2.11	53.7	.27	6.9	50	
12G-12FL90MXBULK	7103-2953	3/4	19.0	3/4	1.50	38.1	2.13	54.1	4.40	111.7	2.39	60.7	.27	6.7	35	
16G-16FL90SXBULK	7103-2970	1	25.4	1	1.75	44.4	2.38	60.5	5.04	128.1	2.81	71.3	.32	8.0	20	
20G-20FL90SXBULK	7103-2988	1 1/4	31.7	1 1/4	2.00	50.8	3.98	101.0	5.43	138.0	3.11	79.0	.32	8.0	15	

- EQUIPMENT
- HOSE/CPLG. SELECTION
- GLOBALSPIRAL COUPLINGS
- PCM/PCS FERRULES
- MEGACRIMP COUPLINGS**
- POWER CRIMP COUPLINGS
- LOW PRESSURE COUPLINGS
- POLARSEAL COUPLINGS
- C14 COUPLINGS
- PCTS THERMO-PLASTIC COUPLINGS
- FIELD ATTACHABLE G1 & G2 COUPLINGS
- FIELD ATTACHABLE C5 COUPLINGS
- SURELOK AIR BRAKE COUPLINGS
- QUICK DISCONNECT COUPLERS
- NEW BALL VALVES
- ACCESSORIES
- EQUIPMENT AND PARTS





MegaCrimp® Couplings

EQUIPMENT

HOSE/CPLG. SELECTION

GLOBALSPIRAL COUPLINGS

PCM/PCS FERRULES

MEGACRIMP COUPLINGS

POWER CRIMP COUPLINGS

LOW PRESSURE COUPLINGS

POLARSEAL COUPLINGS

C14 COUPLINGS

PCTS THERMO-PLASTIC COUPLINGS

FIELD ATTACHABLE G1 & G2 COUPLINGS

FIELD ATTACHABLE C5 COUPLINGS

SURELOK AIR BRAKE COUPLINGS

QUICK DISCONNECT COUPLERS

NEW BALL VALVES

ACCESSORIES

EQUIPMENT AND PARTS

SAE Male Inverted Swivel

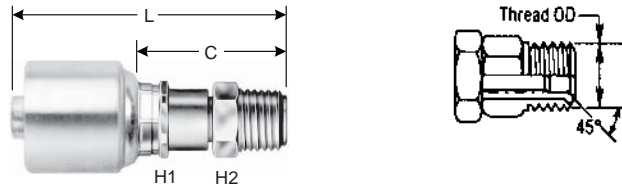

Descr.	Prod. No.	⊖		🌀	H1	H2	L		C		Std. Pack
		"	mm		"	"	"	mm	"	mm	
STANDARD PACK											
4G-4MIX	7100-16225	1/4	6.4	7/16-24	1/2	7/16	2.52	63.9	1.49	37.9	1
4G-5MIX	7100-16235	1/4	6.4	1/2-20	1/2	1/2	2.52	63.9	1.49	37.9	1
6G-4MIX	7100-16185	3/8	9.5	7/16-20	5/8	7/16	2.63	66.9	1.54	39.0	1
6G-5MIX	7100-16245	3/8	9.5	1/2-20	5/8	1/2	2.56	64.9	1.46	37.0	1
6G-6MIX	7100-16255	3/8	9.5	5/8-18	5/8	5/8	2.75	69.9	1.65	42.0	1
6G-7MIX	7100-16265	3/8	9.5	11/16-18	5/8	11/16	2.76	70.0	1.66	42.1	1
8G-6MIX	7100-06275	1/2	12.7	5/8-18	13/16	5/8	3.13	79.5	1.65	42.0	1
8G-8MIX	7100-06285	1/2	12.7	3/4-16	13/16	3/4	3.30	83.8	1.82	46.3	1
10G-10MIX	7100-06295	5/8	15.9	7/8-18	5/8	7/8	3.91	99.5	2.44	62.0	1
BULK PACK											
4G-4MIX XBULK	7100-16222	1/4	6.4	7/16-24	1/2	7/16	2.52	63.9	1.49	37.9	200
4G-5MIX XBULK	7100-16233	1/4	6.4	1/2-20	1/2	1/2	2.52	63.9	1.49	37.9	200
6G-5MIX XBULK	7100-16244	3/8	9.5	1/2-20	5/8	1/2	2.56	64.9	1.46	37.0	125
6G-6MIX XBULK	7100-16255	3/8	9.5	5/8-18	5/8	5/8	2.75	69.9	1.65	42.0	100
6G-7MIX XBULK	7100-16266	3/8	9.5	11/16-18	5/8	11/16	2.76	70.0	1.66	42.1	150
8G-8MIX XBULK	7100-06288	1/2	12.7	3/4-16	13/16	3/4	3.30	83.8	1.82	46.3	100

SAE Male Inverted Swivel - 45° Bent Tube

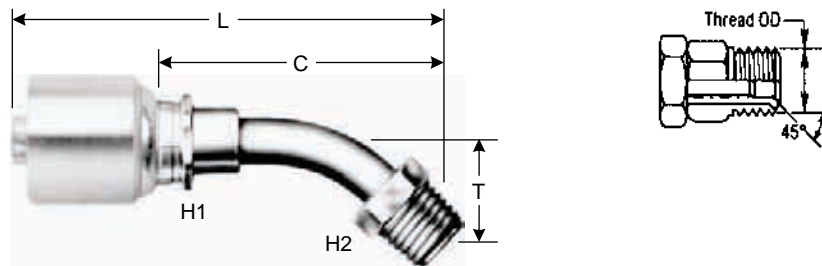

Descr.	Prod. No.	⊖		🌀	H1	H2	T	L		C		Std. Pack	
		"	mm		"	"	"	mm	"	mm	"		mm
STANDARD PACK													
4G-3MIX45-018	7100-16275	1/4	6.4	3/8-24	1/2	3/8	.69	17.5	2.67	67.9	1.65	41.9	1
6G-4MIX45	7100-16305	3/8	9.5	7/16-24	5/8	7/16	1.00	25.4	3.17	80.5	2.07	52.6	1
6G-5MIX45	7100-16315	3/8	9.5	1/2-20	5/8	1/2	1.00	25.4	3.13	79.5	2.03	51.6	1
6G-6MIX45	7100-16325	3/8	9.5	5/8-18	5/8	5/8	1.00	25.4	3.32	84.3	2.22	56.4	1
6G-7MIX45	7100-16335	3/8	9.5	11/16-18	5/8	11/16	1.00	25.4	3.39	86.0	2.29	58.1	1
8G-8MIX45	7100-16345	1/2	12.7	3/4-18	13/16	3/4	1.14	29.0	4.17	106.0	2.70	68.5	1
10G-10MIX45	7100-16435	5/8	15.9	7/8-18	15/16	7/8	1.02	25.9	4.23	107.7	2.75	70.1	1
BULK PACK													
6G-6MIX45XBULK	7100-1632	3/8	9.5	5/8-18	5/8	5/8	1.00	25.4	3.32	84.3	2.22	56.4	150





SAE Male Inverted Swivel - 90° Bent Tube

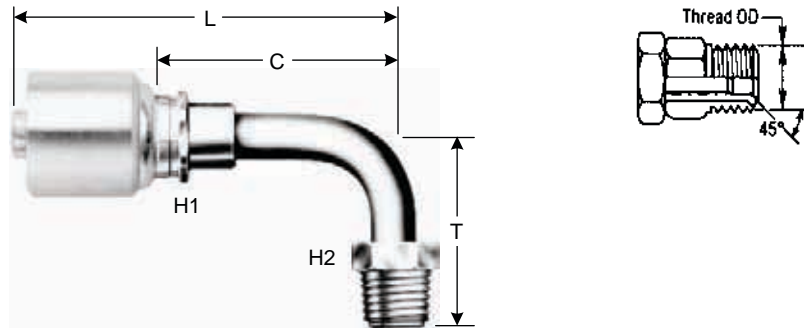

Descr.	Prod. No.	⌀			H1	H2	T		L		C		Std. Pack
		"	mm				"	mm	"	mm	"	mm	
STANDARD PACK													
4G-4MIX90	7100-16355	1/4	6.4	7/16-24	1/2	7/16	1.38	35.1	2.33	59.2	1.31	33.2	1
4G-5MIX90	7100-16365	1/4	6.4	1/2-20	1/2	1/2	1.38	35.1	2.46	62.5	1.44	36.5	1
5G-6MIX90-035	7100-16385	5/16	7.9	5/8-18	5/8	5/8	1.38	35.1	2.78	70.5	1.67	42.5	1
6G-4MIX90	7100-16395	3/8	9.5	7/16-24	5/8	7/16	1.38	35.1	2.44	62.0	1.34	34.1	1
6G-5MIX90	7100-16405	3/8	9.5	1/2-20	5/8	1/2	1.38	35.1	2.50	63.5	1.40	35.6	1
6G-6MIX90	7100-16415	3/8	9.5	5/8-18	5/8	5/8	1.38	35.1	2.80	71.0	1.70	43.1	1
6G-7MIX90	7100-16425	3/8	9.5	11/16-18	5/8	11/16	1.38	35.1	2.80	71.0	1.70	43.1	1
8G-8MIX90	7100-06435	1/2	12.7	3/4-18	13/16	3/4	1.64	41.7	3.29	83.5	1.81	46.0	1
10G-10MIX90	7100-06335	5/8	15.9	7/8-18	15/16	7/8	1.81	46.0	3.87	98.6	2.40	61.2	1
BULK PACK													
4G-4MIX90XBULK	7100-16355	1/4	6.4	7/16-24	1/2	7/16	1.38	35.1	2.33	59.2	1.31	33.2	175
6G-5MIX90XBULK	7100-16405	3/8	9.5	1/2-20	5/8	1/2	1.38	35.1	2.50	63.5	1.40	35.6	200
6G-6MIX90XBULK	7100-16415	3/8	9.5	5/8-18	5/8	5/8	1.38	35.1	2.80	71.0	1.70	43.1	100
6G-7MIX90XBULK	7100-16425	3/8	9.5	11/16-18	5/8	11/16	1.38	35.1	2.80	71.0	1.70	43.1	150

SAE Male Flareless Assembly

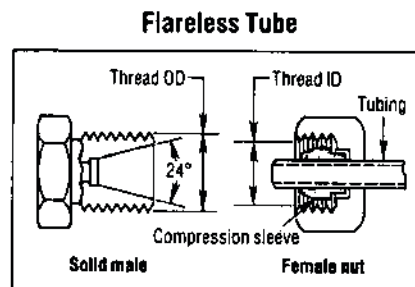
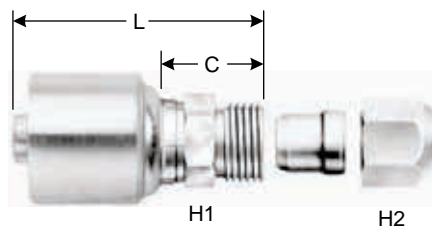

Descr.	Prod. No.	⌀			H1	H2	L		C		Std. Pack
		"	mm				"	mm	"	mm	
STANDARD PACK											
4G-4MFA	7100-16445	1/4	6.4	7/16-20	1/2	9/16	1.95	49.5	.93	23.5	1
4G-5MFA	7100-16455	1/4	6.4	1/2-20	1/2	5/8	1.97	50.0	.94	24.0	1
5G-5MFA	7100-16515	5/16	7.9	1/2-20	5/8	5/8	2.13	54.0	1.02	26.0	1
5G-6MFA	7100-16505	5/16	7.9	9/16-18	5/8	11/16	2.21	56.1	1.11	28.1	1
6G-4MFA	7100-16465	3/8	9.5	7/16-20	5/8	7/8	20.50	52.0	.95	24.1	1
6G-5MFA	7100-16475	3/8	9.5	1/2-20	5/8	5/8	2.16	55.0	1.07	27.1	1



EQUIPMENT
HOSE/CPLG. SELECTION
GLOBALSPIRAL COUPLINGS
PCM/PCS FERRULES
MEGACRIMP COUPLINGS
POWER CRIMP COUPLINGS
LOW PRESSURE COUPLINGS
POLARSEAL COUPLINGS
C14 COUPLINGS
PCTS THERMO-PLASTIC COUPLINGS
FIELD ATTACHABLE G1 & G2 COUPLINGS
FIELD ATTACHABLE C5 COUPLINGS
SURELOK AIR BRAKE COUPLINGS
QUICK DISCONNECT COUPLERS
NEW BALL VALVES
ACCESSORIES
EQUIPMENT AND PARTS

MegaCrimp® Couplings



EQUIPMENT
HOSE/CPLG. SELECTION
GLOBALSPIRAL COUPLINGS
PCM/PCS FERRULES
MEGACRIMP COUPLINGS
POWER CRIMP COUPLINGS
LOW PRESSURE COUPLINGS
POLARSEAL COUPLINGS
C14 COUPLINGS
PCTS THERMO-PLASTIC COUPLINGS
FIELD ATTACHABLE G1 & G2 COUPLINGS
FIELD ATTACHABLE C5 COUPLINGS
SURELOK AIR BRAKE COUPLINGS
QUICK DISCONNECT COUPLERS
NEW BALL VALVES
ACCESSORIES
EQUIPMENT AND PARTS

SAE Male Flareless Assembly - Cont'd

Descr.	Prod. No.	⊖			H1	H2	L		C		Std. Pack
		"	mm		"	"	"	mm	"	mm	
6G-6MFA	7100-16485	3/8	9.5	9/16-18	5/8	11/16	2.07	52.5	.97	24.6	5
6G-8MFA	7100-16495	3/8	9.5	3/4-16	3/4	7/8	2.20	56.0	1.11	28.1	1
8G-8MFA	7100-06505	1/2	12.7	3/4-16	13/16	7/8	2.58	65.5	1.10	28.0	1
8G-10MFA	7100-06515	1/2	12.7	7/8-14	7/8	1	2.64	67.0	1.16	29.5	1
12G-12MFA	7100-06525	3/4	19.0	1 1/16-12	1 1/16	1 1/4	3.41	86.5	1.40	35.5	1
16G-16MFA	7100-06535	1	25.4	1 5/16	1 3/8	1 1/2	3.94	100.0	1.70	43.2	1
BULK PACK											
4G-4MFAXBULK	7100-1644	1/4	6.4	7/16-20	1/2	9/16	1.95	49.5	.93	23.5	150
4G-5MFAXBULK	7100-1645	1/4	6.4	1/2-20	1/2	5/8	1.97	50.0	.94	24.0	125
6G-4MFAXBULK	7100-1646	3/8	9.5	7/16-20	5/8	7/8	2.05	52.0	.95	24.1	150
6G-5MFAXBULK	7100-1647	3/8	9.5	1/2-20	5/8	5/8	2.16	55.0	1.07	27.1	150
6G-6MFAXBULK	7100-1648	3/8	9.5	9/16-18	5/8	11/16	2.07	52.5	.97	24.6	200
6G-8MFAXBULK	7100-1649	3/8	9.5	3/4-16	3/4	7/8	2.20	56.0	1.11	28.1	150
8G-8MFAXBULK	7100-0650	1/2	12.7	3/4-16	13/16	7/8	2.58	65.5	1.10	28.0	100
8G-10MFAXBULK	7100-0651	1/2	12.7	7/8-14	7/8	1	2.64	67.0	1.16	29.5	125
12G-12MFAXBULK	7100-0652	3/4	19.0	1 1/16-12	1 1/16	1 1/4	3.41	86.5	1.40	35.5	60
16G-16MFAXBULK	7100-0653	1	25.4	1 5/16	1 3/8	1 1/2	3.94	100.0	1.70	43.2	30

North American Stand Pipe

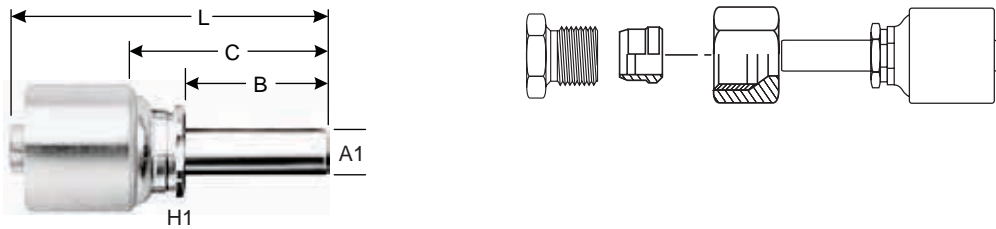

Descr.	Prod. No.	⊖		H1	L		C		B		A1	Std. Pack
		"	mm	"	"	mm	"	mm	"	mm	"	
STANDARD PACK												
4G-4NASP	7100-08305	1/4	6.4	1/2	2.26	57.5	1.24	31.5	.88	22.4	1/4	1
6G-6NASP	7100-08335	3/8	9.5	5/8	2.34	59.5	1.24	31.6	.88	22.4	3/8	1
8G-8NASP	7100-08365	1/2	12.7	13/16	2.87	73.0	1.40	35.5	1.00	25.4	1/2	1
12G-12NASP	7100-08435	3/4	19.0	1 1/16	3.58	91.0	1.57	40.0	1.16	29.5	3/4	1
16G-16NASP	7100-08465	1	25.4	1 7/16	3.86	98.0	1.62	41.2	1.12	28.4	1	1

Female Flareless Sleeve



Descr.	Prod. No.	A1	Std. Pack
STANDARD PACK			
4FFS	7334-40555	1/4	5
5FFS	7334-40565	5/16	5
6FFS	7334-40575	3/8	5
8FFS	7334-40435	1/2	5





Female Flareless Sleeve - Cont'd

Descr.	Prod. No.	A1	Std. Pack
		"	
10FFS	7334-40585	5/8	1
12FFS	7334-40595	3/4	1
16FFS	7334-40605	1	1

Female Flareless Nut



Descr.	Prod. No.	A1		H1	Std. Pack
		"		"	
STANDARD PACK					
4FFN	7334-40495	1/4	7/16-20	9/16	5
5FFN	7334-40505	5/16	1/2-20	5/8	5
6FFN	7334-40515	3/8	9/16-18	11/16	5
8FFN	7334-40425	1/2	3/4-16	7/8	5
10FFN	7334-40525	5/8	7/8-14	1	1
12FFN	7334-40535	3/4	1 1/16-12	1 1/4	1
16FFN	7334-40545	1	1 5/16-12	1 1/2	1

Hose Length Extender

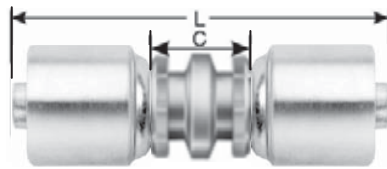

Descr.	Prod. No.	⊖			L		C		Std. Pack
		"	mm		"	mm	"	mm	
STANDARD PACK									
20G-20HLE	7101-50705	1 1/4	31.7	1 1/4	5.96	151.5	1.32	33.5	1

Female Air Brake Swivel

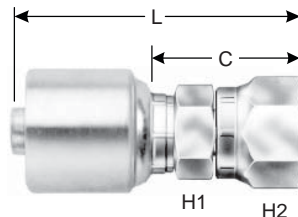

Descr.	Prod. No.	⊖			H1	H2	L		C		Std. Pack
		"	mm		"	"	"	mm	"	mm	
STANDARD PACK											
6G-6FABX	7100-13095	3/8	9.5	3/4-20	3/4	7/8	2.41	61.2	1.31	33.3	1

EQUIPMENT

HOSE/CPLG. SELECTION

GLOBALSPIRAL COUPLINGS

PCM/PCS FERRULES

MEGACRIMP COUPLINGS

POWER CRIMP COUPLINGS

LOW PRESSURE COUPLINGS

POLARSEAL COUPLINGS

C14 COUPLINGS

PCTS THERMO-PLASTIC COUPLINGS

FIELD ATTACHABLE G1 & G2 COUPLINGS

FIELD ATTACHABLE C5 COUPLINGS

SURELOK AIR BRAKE COUPLINGS

QUICK DISCONNECT COUPLERS

NEW BALL VALVES

ACCESSORIES

EQUIPMENT AND PARTS





MegaCrimp® Couplings

EQUIPMENT
HOSE/CPLG. SELECTION
GLOBALSPIRAL COUPLINGS
PCM/PCS FERRULES
MEGACRIMP COUPLINGS
POWER CRIMP COUPLINGS
LOW PRESSURE COUPLINGS
POLARSEAL COUPLINGS
C14 COUPLINGS
PCTS THERMO-PLASTIC COUPLINGS
FIELD ATTACHABLE G1 & G2 COUPLINGS
FIELD ATTACHABLE C5 COUPLINGS
SURELOK AIR BRAKE COUPLINGS
QUICK DISCONNECT COUPLERS
NEW BALL VALVES
ACCESSORIES
EQUIPMENT AND PARTS

Female Air Brake Swivel - Cont'd

Descr.	Prod. No.	⊖			H1	H2	L		C		Std. Pack
		"	mm		"	"	"	mm	"	mm	
8G-6FABX	7100-13105	1/2	12.7	3/4-20	13/16	7/8	2.48	63.0	1.00	25.5	1
8G-8FABX	7100-13125	1/2	12.7	7/8-20	13/16	1 1/16	3.02	76.7	1.19	30.2	1

Female Grease

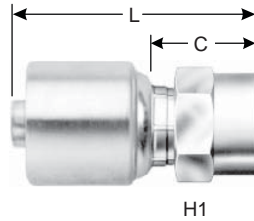

Descr.	Prod. No.	⊖			H1	H2	L		C		Std. Pack
		"	mm		"	"	"	mm	"	mm	
STANDARD PACK											
4G-8FG	7100-09605	1/4	6.4	1/2-27	11/16	—	1.87	47.5	.85	21.5	1
6G-8FG	7100-09615	3/8	9.5	1/2-27	11/16	—	1.93	49.1	.83	21.2	1

Female Parker Triple Thread Flare

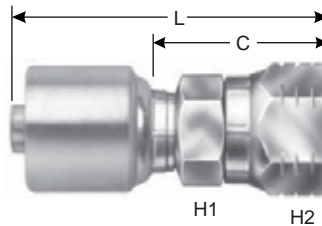



Descr.	Prod. No.	⊖			H1	H2	L		C		Std. Pack
		"	mm		"	"	"	mm	"	mm	
STANDARD PACK											
16G-16FZX	7100-00015	1	25.4	1 5/16-14	1 3/8	1 1/2	3.98	101.0	1.74	44.3	1

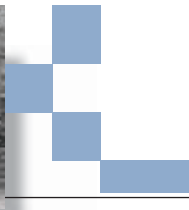

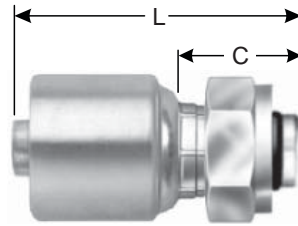

Pressure Wash Swivel



Descr.	Prod. No.	⊖			L		C		Std. Pack
		"	mm		"	mm	"	mm	
STANDARD PACK									
4G-6PWX	7100-02905	1/4	6.4	M22X1.5	2.52	64.0	1.50	38.0	1
6G-6PWX	7100-02915	3/8	9.5	M22X1.5	2.60	66.0	1.50	38.1	1

International Thread British Std Pipe Banjo

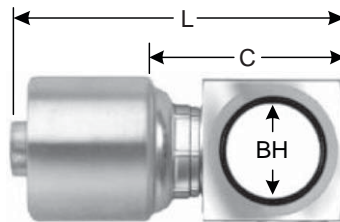

Descr.	Prod. No.	⊖		L		C		BH	Std. Pack
		"	mm	"	mm	"	mm	mm	
STANDARD PACK									
4G-4BSPBJ	7100-92565	1/4	6.4	2.10	53.4	1.19	30.3	13.2	1
6G-6BSPBJ	7100-92575	3/8	9.5	2.20	55.8	1.30	32.4	16.8	1
8G-8BSPBJ	7100-92925	1/2	12.7	2.80	70.7	1.50	38.2	21.0	1

International Thread Metric 7642 DIN Banjo

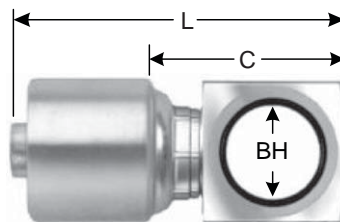

Descr.	Prod. No.	⊖		L		C		BH	Std. Pack
		"	mm	"	mm	"	mm	mm	
STANDARD PACK									
4G-12DBJ	7100-91195	1/4	6.4	2.06	51.4	1.11	28.3	12.1	1
6G-12DBJ	7100-98125	1/2	12.7	2.20	56.0	1.11	28.1	12.1	1
6G-14DBJ	7100-91275	3/8	9.5	2.29	58.3	1.19	30.4	14.1	1
6G-16DBJ	7100-91285	3/8	9.5	2.20	55.8	1.27	32.4	16.1	1

EQUIPMENT

HOSE/CPLG. SELECTION

GLOBALSPIRAL COUPLINGS

PCM/PCS FERRULES

MEGACRIMP COUPLINGS

POWER CRIMP COUPLINGS

LOW PRESSURE COUPLINGS

POLARSEAL COUPLINGS

C14 COUPLINGS

PCTS THERMO-PLASTIC COUPLINGS

FIELD ATTACHABLE G1 & G2 COUPLINGS

FIELD ATTACHABLE C5 COUPLINGS

SURELOK AIR BRAKE COUPLINGS

QUICK DISCONNECT COUPLERS

NEW BALL VALVES

ACCESSORIES

EQUIPMENT AND PARTS





MegaCrimp® Couplings

International Thread Metric 7642 DIN Banjo - Cont'd

Descr.	Prod. No.	⊖		L		C		BH	Std. Pack
		"	mm	"	mm	"	mm		
6G-18DBJ	7100-91295	3/8	9.5	2.27	57.8	1.35	34.4	18.1	1
8G-18DBJ	7100-91305	1/2	12.7	2.64	67.2	1.37	34.7	18.1	1
12G-26DBJ	7100-93895	3/4	19.0	3.73	94.7	3.23	82.1	26.1	1
16G-30DBJ	7100-94995	1	25.1	4.30	109.2	2.06	52.4	30.1	1

Male DIN 24° Cone - Light Series

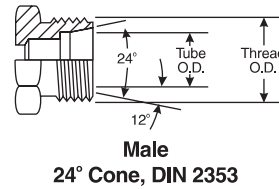
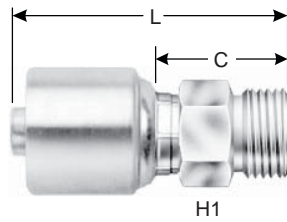

Descr.	Prod. No.	⊖		🌀	H1	H2	L		C		Std. Pack	
		"	mm		mm	mm	"	mm	"	mm		
STANDARD PACK												
C14 COUPLINGS	4G-6MDL	7100-92685	1/4	6.4	M12X1.5	14.0	—	1.69	42.9	.78	19.8	1
	4G-8MDL	7100-14835	1/4	6.4	M14X1.5	17.0	—	1.97	50.0	.94	24.0	1
	4G-10MDL	7100-14845	1/4	6.4	M16X1.5	17.0	—	2.01	51.0	.98	25.0	1
PCTS THERMO-PLASTIC COUPLINGS	6G-10MDL	7100-14865	3/8	9.5	M16X1.5	17.0	—	2.07	52.5	.97	24.6	1
	6G-12MDL	7100-14875	3/8	9.5	M18X1.5	19.0	—	2.07	52.5	.97	24.6	1
	6G-15MDL	7100-92695	3/8	9.5	M22X1.5	24.0	—	1.86	47.3	.94	23.9	1
FIELD ATTACHABLE G1 & G2 COUPLINGS	8G-15MDL	7100-04885	1/2	12.7	M22X1.5	24.0	—	2.56	65.0	1.08	27.5	1
	10G-18MDL	7100-04895	5/8	15.8	M26X1.5	27.0	—	2.56	65.0	1.08	27.5	1
	10G-22MDL	7100-04935	5/8	15.9	M30X2.0	32.0	—	2.73	69.6	1.26	32.3	1
	12G-22MDL	7100-04905	3/4	19.0	M30X2.0	32.0	—	3.27	83.0	1.26	32.0	1
	16G-28MDL	7100-04915	1	15.8	M36X2.0	32.0	—	1.26	32.0	3.27	83.0	1
20G-35MDL	7100-04925	1 1/4	31.8	M45X2.0	46.0	—	3.90	99.3	1.58	40.4	1	
BULK PACK												
FIELD ATTACHABLE C5 COUPLINGS	6G-10MDLXBULK	7100-1486	3/8	9.5	M16X1.5	17.0	—	2.07	52.5	.97	24.6	125
	6G-12MDLXBULK	7100-1487	3/8	9.5	M18X1.5	19.0	—	2.07	52.5	.97	24.6	150

Female DIN 24° Cone Swivel - Light Series with O-Ring

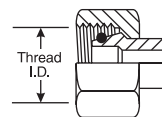
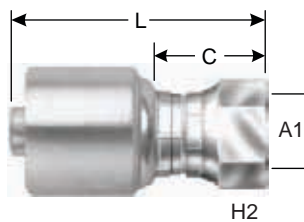

Descr.	Prod. No.	⊖		🌀	H1	H2	L		C		A1	Std. Pack	
		"	mm		mm	mm	"	mm	"	mm	mm		
STANDARD PACK													
EQUIPMENT AND PARTS	4G-6FDLORX	7100-92135	1/4	6.4	M12X1.5	—	14.0	1.92	48.7	1.01	25.8	6.0	1
	4G-8FDLORX	7100-91995	1/4	6.4	M14X1.5	—	17.0	2.02	51.3	1.12	28.4	8.0	1







Female DIN 24° Cone Swivel - Light Series with O-Ring - Cont'd

Descr.	Prod. No.	⊖			H1	H2	L		C		A1	Std. Pack
		"	mm		mm	mm	"	mm	"	mm	mm	
4G-10FDLORX	7100-92145	1/4	6.4	M16X1.5	—	19.0	2.17	55.2	1.15	29.3	10.0	1
4G-12FDLORX	7100-92865	1/4	6.4	M18X1.5	—	22.0	2.07	52.6	1.17	29.7	12.0	1
5G-10FDLORX	7100-92015	5/16	7.9	M16X1.5	—	19.0	2.12	53.9	1.17	29.7	10.0	1
5G-12FDLORX	7100-92035	5/16	7.9	M18X1.5	—	22.0	2.13	54.1	1.18	29.9	12.0	1
6G-10FDLORX	7100-92175	3/8	9.5	M16X1.5	—	19.0	2.06	52.3	1.15	29.2	10.0	1
6G-12FDLORX	7100-92055	3/8	9.5	M18X1.5	—	22.0	2.09	53.0	1.18	29.9	12.0	1
8G-15FDLORX	7100-92075	1/2	12.7	M22X1.5	—	27.0	2.43	61.8	1.16	29.3	15.0	1
10G-18FDLORX	7100-92095	5/8	15.8	M26X1.5	—	32.0	2.36	60.0	1.19	30.3	18.0	1
12G-18FDLORX	7100-92825	3/4	19.0	M30X2.0	—	32.0	2.70	68.5	1.18	30.0	18.0	1
12G-22FDLORX	7100-92115	3/4	19.0	M30X2.0	—	36.0	2.79	70.8	1.27	32.3	22.0	1
16G-28FDLORX	7100-92205	1	25.4	M36X2.0	—	41.0	3.21	81.6	1.45	36.7	28.0	1
20G-35FDLORX	7100-92215	1 1/4	31.8	M45X2.0	—	36.0	3.56	90.3	1.74	44.1	35.0	1
20G-42FDLORX	7100-95305	1 1/4	31.8	M48X2.0	—	60.0	4.25	108.0	1.93	49.0	—	1
BULK PACK												
4G-8FDLORX XBULK	7100-9199	1/4	6.4	M14X1.5	—	17.0	2.02	51.3	1.12	28.4	8.0	200
4G-12FDLORX XBULK	7100-9286	1/4	6.4	M18X1.5	—	22.0	2.07	52.6	1.17	29.7	12.0	200
6G-10FDLORX XBULK	7100-9217	3/8	9.5	M16X1.5	—	19.0	2.06	52.3	1.15	29.2	10.0	230
6G-12FDLORX XBULK	7100-9205	3/8	9.5	M18X1.5	—	22.0	2.09	53.0	1.18	29.9	12.0	200
8G-15FDLORX XBULK	7100-9207	1/2	12.7	M22X1.5	—	27.0	2.43	61.8	1.16	29.3	15.0	100
10G-18FDLORX XBULK	7100-9209	5/8	15.8	M26X1.5	—	32.0	2.36	60.0	1.19	30.3	18.0	100
12G-22FDLORX XBULK	7100-9211	3/4	19.0	M30X2.0	—	36.0	2.79	70.8	1.27	32.3	22.0	60

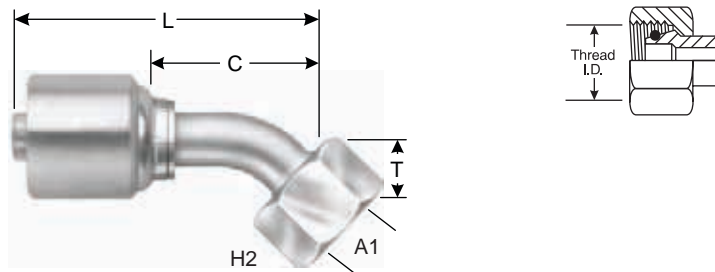
Female DIN 24° Cone Swivel - Light Series with O-Ring - 45° Bent Tube



Descr.	Prod. No.	⊖			H1	H2	T		L		C		A1	Std. Pack
		"	mm		mm	mm	"	mm	"	mm	"	mm	mm	
STANDARD PACK														
4G-8FDLORX45	7100-91855	1/4	6.4	M14X1.5	—	17.0	.64	16.2	2.34	59.5	1.44	36.5	8.0	1
4G-10FDLORX45	7100-92265	1/4	6.4	M16X1.5	—	19.0	.70	17.9	2.41	61.3	1.51	38.3	10.0	1
5G-10FDLORX45	7100-91895	5/16	7.9	M16X1.5	—	19.0	.67	17.1	2.50	63.4	1.55	39.3	10.0	1
6G-10FDLORX45	7100-92295	3/8	9.5	M16X1.5	—	19.0	.73	18.6	2.50	63.6	1.59	40.5	10.0	1
6G-12FDLORX45	7100-91875	3/8	9.5	M18X1.5	—	22.0	.74	18.9	2.52	64.0	1.61	40.9	12.0	1
6G-15FDLORX45	7100-92315	3/8	9.5	M22X1.5	—	27.0	.89	22.5	2.66	67.5	1.75	44.4	15.0	1
8G-15FDLORX45	7100-91935	1/2	12.7	M22X1.5	—	27.0	.79	20.2	3.13	79.5	1.85	47.1	15.0	1
10G-18FDLORX45	7100-91955	5/8	15.9	M26X1.5	—	32.0	.98	24.8	3.37	85.7	2.21	56.0	18.0	1
12G-22FDLORX45	7100-91975	3/4	19.0	M30X2.0	—	36.0	1.17	29.8	4.12	104.6	2.60	66.1	22.0	1
16G-28FDLORX45	7100-92325	1	25.4	M36X2.0	—	41.0	1.21	30.9	4.87	123.7	3.10	78.8	28.0	1
20G-35FDLORX45	7100-92335	1 1/4	31.7	M45X2.0	—	50.0	1.48	37.5	5.48	139.3	3.68	93.4	35.0	1

EQUIPMENT
HOSE/CPLG. SELECTION
GLOBAL SPIRAL COUPLINGS
PCM/PCS FERRULES
MEGACRIMP COUPLINGS
POWER CRIMP COUPLINGS
LOW PRESSURE COUPLINGS
POLARSEAL COUPLINGS
C14 COUPLINGS
PCTS THERMO-PLASTIC COUPLINGS
FIELD ATTACHABLE G1 & G2 COUPLINGS
FIELD ATTACHABLE C5 COUPLINGS
SURELOK AIR BRAKE COUPLINGS
QUICK DISCONNECT COUPLERS
NEW BALL VALVES
ACCESSORIES
EQUIPMENT AND PARTS



MegaCrimp® Couplings

Female DIN 24° Cone Swivel - Light Series with O-Ring - 90° Bent Tube

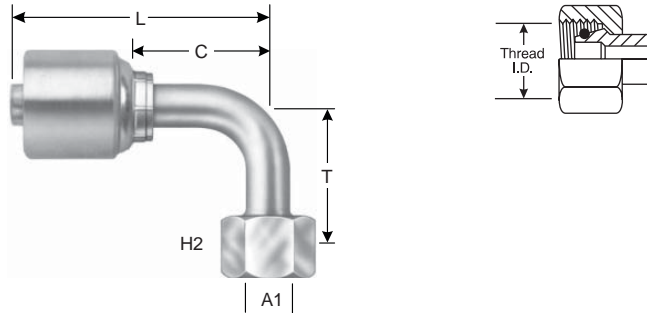

Descr.	Prod. No.	⊖		🌀	H1	H2	T		L		C		A1	Std. Pack	
		"	mm		mm	mm	"	mm	"	mm	"	mm	mm		
STANDARD PACK															
4G-6FDLORX90	7100-92375	1/4	6.4	M12X1.5	—	14.0	1.38	35.0	2.15	54.5	1.24	31.5	6.0	1	
4G-8FDLORX90	7100-91685	1/4	6.4	M14X1.5	—	17.0	1.38	35.0	2.15	54.5	1.24	31.5	8.0	1	
POLARSEAL COUPLINGS	4G-10FDLORX90	7100-92385	1/4	6.4	M16X1.5	—	19.0	1.44	36.5	2.14	54.5	1.24	31.5	10.0	1
	5G-10FDLORX90	7100-91725	5/16	9.5	M16X1.5	—	19.0	1.44	36.5	2.31	58.6	1.35	34.4	10.0	1
C14 COUPLINGS	6G-10FDLORX90	7100-92415	3/8	9.5	M16X1.5	—	19.0	1.44	36.5	2.18	55.3	1.27	32.2	10.0	1
	6G-12FDLORX90	7100-91705	3/8	9.5	M18X1.5	—	22.0	1.46	37.0	2.18	55.3	1.27	32.2	12.0	1
PCTS THERMO-PLASTIC COUPLINGS	8G-15FDLORX90	7100-91765	1/2	12.7	M22X1.5	—	27.0	1.65	42.0	2.87	72.8	1.59	40.4	15.0	1
	10G-18FDLORX90	7100-91785	5/8	15.8	M26X1.5	—	32.0	2.03	51.5	3.04	77.3	1.87	47.6	18.0	1
	12G-22FDLORX90	7100-91805	3/4	19.0	M30X2.0	—	36.0	2.44	62.0	3.73	94.8	2.22	56.3	22.0	1
FIELD ATTACHABLE G1 & G2 COUPLINGS	16G-28FDLORX90	7100-92445	1	25.4	M36X2.0	—	41.0	2.76	70.0	4.69	119.2	2.93	74.3	28.0	1
	20G-35FDLORX90	7100-92455	1 1/4	31.8	M45X2.0	—	36.0	3.15	80.0	5.07	128.8	3.26	82.8	35.0	1
	BULK PACK														
4G-8FDLORX90XBULK	7100-9168	1/4	6.4	M12X1.5	—	17.0	1.38	35.0	2.15	54.5	1.24	31.5	8.0	250	
6G-12FDLORX90XBULK	7100-9170	3/8	9.5	M18X1.5	—	22.0	1.46	37.0	2.18	55.3	1.27	32.2	12.0	175	
8G-15FDLORX90XBULK	7100-9176	1/2	12.7	M22X1.5	—	27.0	1.65	42.0	2.87	72.8	1.59	40.4	15.0	120	
10G-18FDLORX90XBULK	7100-9178	5/8	15.8	M26X1.5	—	32.0	2.03	51.5	3.04	77.3	1.87	47.6	18.0	75	

Female French GAZ Swivel

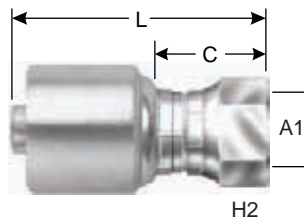

Descr.	Prod. No.	⊖		🌀	H1	H2	L		C		Std. Pack
		"	mm		mm	mm	"	mm	"	mm	
STANDARD PACK											
8G-17FFGX	7100-93555	1/2	12.7	M24X1.5	—	24.0	2.49	63.4	1.01	25.9	1

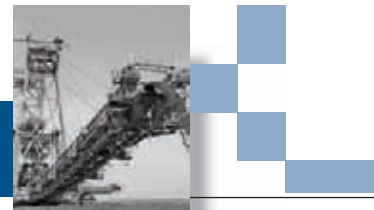

Male DIN 24° Cone - Heavy Series

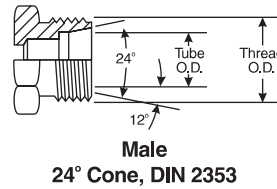
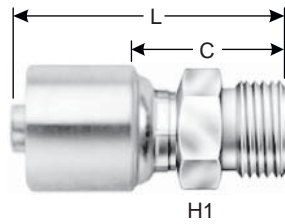

Descr.	Prod. No.	⊖			H1	H2	L		C		A1	Std. Pack
		"	mm				"	mm	"	mm		
STANDARD PACK												
4G-8MDH	7100-15315	1/4	6.4	M16X1.5	17.0	—	2.09	53.0	1.06	27.0	8.0	1
4G-10MDH	7100-15325	1/4	6.4	M18X1.5	19.0	—	2.07	52.5	1.04	26.5	10.0	1
5G-12MDH	7100-93015	5/16	7.9	M20X1.5	22.0	—	2.04	51.9	1.09	27.8	12.0	1
6G-10MDH	7100-15345	3/8	9.5	M18X1.5	19.0	—	2.07	52.5	.97	24.6	10.0	1
6G-12MDH	7100-15355	3/8	9.5	M20X1.5	24.0	—	2.26	57.5	1.17	29.6	12.0	1
6G-14MDH	7100-15365	3/8	9.5	M22X1.5	24.0	—	2.34	59.5	1.24	31.6	12.0	1
8G-12MDH	7100-94815	1/2	12.7	M20X1.5	24.0	—	2.42	61.5	1.14	29.0	12.0	1
8G-16MDH	7100-05375	1/2	12.7	M24X1.5	27.0	—	2.72	69.0	1.24	31.5	16.0	1
10G-20MDH	7100-05385	5/8	15.8	M30X2.0	32.0	—	2.89	73.5	1.42	36.0	20.0	1
12G-20MDH	7100-92755	3/4	19.1	M30X2.0	32.0	—	2.85	72.3	1.33	33.9	20.0	1
12G-25MDH	7100-05395	3/4	19.0	M36X2.0	41.0	—	3.62	92.0	1.61	41.0	25.0	1
16G-30MDH	7100-92535	1	25.4	M42X2.0	16.0	—	3.48	88.3	1.67	42.4	30.0	1
20G-38MDH	7100-92545	1 1/4	31.7	M52X2.0	55.0	—	3.72	94.4	1.93	49.1	38.0	1

Female DIN 24° Cone Swivel - Heavy Series with O-Ring

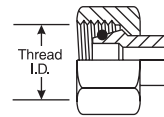
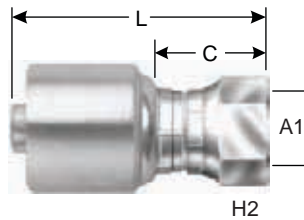

Descr.	Prod. No.	⊖			H1	H2	L		C		A1	Std. Pack
		"	mm				"	mm	"	mm		
STANDARD PACK												
4G-8FDHORX	7100-92005	1/4	6.4	M16X1.5	—	19.0	2.02	51.3	1.12	28.4	8.0	1
4G-10FDHORX	7100-92155	1/4	6.4	M18X1.5	—	22.0	2.06	52.2	1.15	29.3	10.0	1
4G-12FDHORX	7100-92875	5/16	7.9	M18X1.5	—	22.0	2.07	52.6	1.17	29.7	12.0	1
5G-12FDHORX	7100-92045	5/16	7.9	M20X1.5	—	24.0	2.28	58.0	1.18	30.0	12.0	1
5G-14FDHORX	7100-94835	5/16	7.9	M22X1.5	—	27.0	2.11	53.6	1.18	30.0	14.0	1
6G-10FDHORX	7100-92185	3/8	9.5	M18X1.5	—	22.0	2.06	52.3	1.15	29.2	10.0	1
6G-12FDHORX	7100-92065	3/8	9.5	M20X1.5	—	24.0	2.09	53.0	1.18	29.9	12.0	1
6G-14FDHORX	7100-93305	3/8	9.5	M22X1.5	—	27.0	2.19	55.6	1.28	32.5	14.0	1
8G-12FDHORX	7100-93335	1/2	12.7	M20X1.5	—	24.0	2.76	70.2	1.29	32.7	12.0	1
8G-14FDHORX	7100-94795	1/2	12.7	M22X1.5	—	27.0	2.56	65.0	1.28	32.5	14.0	1
8G-16FDHORX	7100-92085	1/2	12.7	M24X1.5	—	30.0	2.60	66.1	1.32	33.6	16.0	1
10G-20FDHORX	7100-92105	5/8	15.9	M30X1.5	—	36.0	2.67	67.9	1.51	38.2	20.0	1
12G-20FDHORX	7100-96675	3/4	19.1	M30X2.0	—	36.0	3.61	91.7	1.60	40.7	20.0	1

EQUIPMENT
HOSE/CPLG. SELECTION
GLOBAL SPIRAL COUPLINGS
PCM/PCS FERRULES
MEGACRIMP COUPLINGS
POWER CRIMP COUPLINGS
LOW PRESSURE COUPLINGS
POLARSEAL COUPLINGS
C14 COUPLINGS
PCTS THERMO-PLASTIC COUPLINGS
FIELD ATTACHABLE G1 & G2 COUPLINGS
FIELD ATTACHABLE C5 COUPLINGS
SURELOK AIR BRAKE COUPLINGS
QUICK DISCONNECT COUPLERS
NEW BALL VALVES
ACCESSORIES
EQUIPMENT AND PARTS







MegaCrimp® Couplings

Female DIN 24° Cone Swivel - Heavy Series with O-Ring - Cont'd

Descr.	Prod. No.	⊖			H1	H2	L		C		A1	Std. Pack
		"	mm		mm	mm	"	mm	"	mm	mm	
12G-25FDHORX	7100-92125	3/4	19.0	M36X2.0	—	46.0	3.19	81.1	1.68	42.6	25.0	1
16G-25FDHORX	7100-93215	1	25.4	M42X2.0	—	46.0	4.04	102.5	1.80	45.7	25.0	1
16G-30FDHORX	7100-92235	1	25.4	M42X2.0	—	50.0	3.70	94.1	1.94	49.2	30.0	1
20G-38FDHORX	7100-92245	1 1/4	31.7	M52X2.0	—	60.0	4.10	104.0	2.28	57.8	38.0	1
BULK PACK												
4G-10FDHXORX XBULK	7100-9215	1/4	6.4	M18X1.5	—	22.0	2.06	52.2	1.15	29.3	10.0	150
6G-12FDHORX XBULK	7100-9206	3/8	9.5	M20X1.5	—	24.0	2.09	53.0	1.18	29.9	12.0	150
8G-16FDHORX XBULK	7100-9208	1/2	12.7	M24X1.5	—	30.0	2.60	66.1	1.32	33.6	16.0	100
16G-25FDHORX XBULK	7100-9321	1	25.4	M42X2.0	—	46.0	4.04	102.5	1.80	45.7	25.0	30
16G-30FDHORX XBULK	7100-9223	1	25.4	M42X2.0	—	50.0	3.70	94.1	1.94	49.2	30.0	30

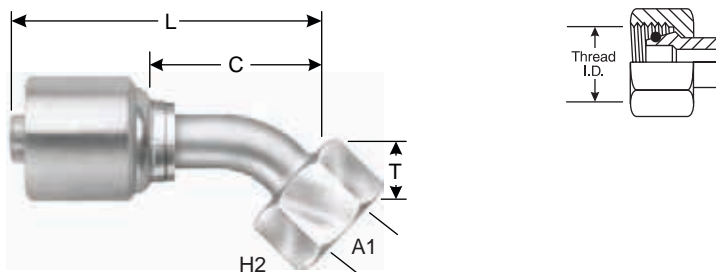
Female DIN 24° Cone Swivel - Heavy Series with O-Ring - 45° Bent Tube



Descr.	Prod. No.	⊖			H1	H2	T		L		C		A1	Std. Pack
		"	mm		mm	mm	"	mm	"	mm	"	mm	mm	
STANDARD PACK														
4G-8FDHORX45	7100-91865	1/4	6.4	M16X1.5	—	19.0	.64	16.2	2.34	59.5	1.44	36.5	8.0	1
6G-12FDHORX45	7100-91885	3/8	9.5	M20X1.5	—	24.0	.74	18.9	2.52	64.0	1.61	40.9	12.0	1
8G-14FDHORX45	7100-94855	1/2	12.7	M22X1.5	—	27.0	1.11	28.3	3.40	86.4	2.13	54.0	14.0	1
8G-16FDHORX45	7100-91945	1/2	12.7	M24X1.5	—	30.0	.85	21.6	3.19	81.0	1.91	48.5	16.0	1
10G-20FDHORX45	7100-91965	5/8	15.9	M30X1.5	—	36.0	.98	24.9	3.36	85.4	2.19	55.7	20.0	1
12G-25FDHORX45	7100-91985	3/4	19.0	M36X2.0	—	46.0	1.23	31.2	4.17	106.0	2.66	67.5	25.0	1

- EQUIPMENT
- HOSE/CPLG. SELECTION
- GLOBALSPIRAL COUPLINGS
- PCM/PCS FERRULES
- MEGACRIMP COUPLINGS
- POWER CRIMP COUPLINGS
- LOW PRESSURE COUPLINGS
- POLARSEAL COUPLINGS
- C14 COUPLINGS
- PCTS THERMO-PLASTIC COUPLINGS
- FIELD ATTACHABLE G1 & G2 COUPLINGS
- FIELD ATTACHABLE C5 COUPLINGS
- SURELOK AIR BRAKE COUPLINGS
- QUICK DISCONNECT COUPLERS
- NEW BALL VALVES
- ACCESSORIES
- EQUIPMENT AND PARTS





Female DIN 24° Cone Swivel - Heavy Series with O-Ring - 90° Bent Tube

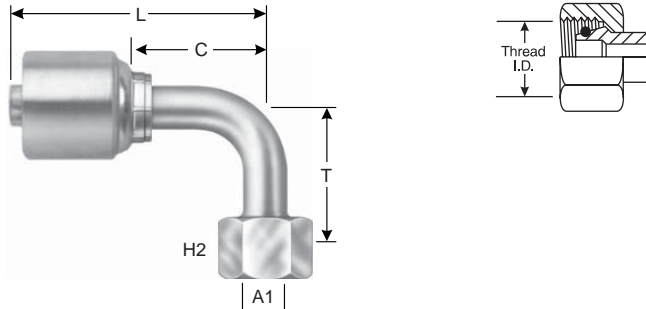

Descr.	Prod. No.	⌀		M	H1	H2	T	L		C		A1	Std. Pack	
		"	mm					"	mm	"	mm			
STANDARD PACK														
4G-8FDHORX90	7100-91695	1/4	6.4	M16X1.5	—	19.0	1.38	35.0	2.14	54.5	1.24	31.5	8.0	1
4G-10FDHORX90	7100-92395	1/4	6.4	M18X1.5	—	22.0	1.44	36.5	2.15	54.5	1.24	31.5	10.0	1
5G-12FDHORX90	7100-91755	5/16	7.9	M20X1.5	—	24.0	1.46	37.0	2.32	59.0	1.22	31.0	12.0	1
5G-14FDHORX90	7100-94845	5/16	7.9	M22X1.5	—	24.0	1.57	40.0	2.15	54.6	1.22	31.0	14.0	1
6G-10FDHORX90	7100-92425	3/8	9.5	M18X1.5	—	22.0	1.44	36.5	2.18	55.3	1.27	32.2	10.0	1
6G-12FDHORX90	7100-91715	3/8	9.5	M20X1.5	—	24.0	1.46	37.0	2.18	55.3	1.27	32.2	12.0	1
6G-14FDHORX90	7100-92465	3/8	9.5	M22X1.5	—	27.0	1.57	40.0	2.18	55.3	1.27	32.2	14.0	1
8G-14FDHORX90	7100-95325	1/2	12.7	M22X1.5	—	27.0	2.01	51.0	2.71	69.1	1.45	36.8	14.0	1
8G-16FDHORX90	7100-91775	1/2	12.7	M24X1.5	—	30.0	1.73	44.0	2.87	72.8	1.59	40.4	16.0	1
10G-20FDHORX90	7100-91795	5/8	15.9	M30X2.0	—	36.0	2.01	51.0	3.00	76.3	1.83	46.6	20.0	1
10G-25FDHORX90	7100-94825	5/8	15.8	M36X2.0	—	46.0	2.52	64.0	3.31	84.1	1.83	46.6	25.0	1
12G-20FDHORX90	7100-93035	3/4	19.0	M30X2.0	—	36.0	2.01	51.0	3.46	87.8	1.94	49.3	20.0	1
12G-25FDHORX90	7100-91815	3/4	19.0	M36X2.0	—	46.0	2.52	64.0	3.73	94.8	2.22	56.3	25.0	1
16G-25FDHORX90	7100-94925	1	25.4	M36X2.0	—	46.0	2.99	76.0	5.43	137.8	4.92	125.9	25.0	1
BULK PACK														
4G-10FDHORX90XBULK	7100-9239	1/4	6.4	M18X1.5	—	22.0	1.44	36.5	2.15	54.5	1.24	31.5	10.0	200

Metric Light Stand Pipe

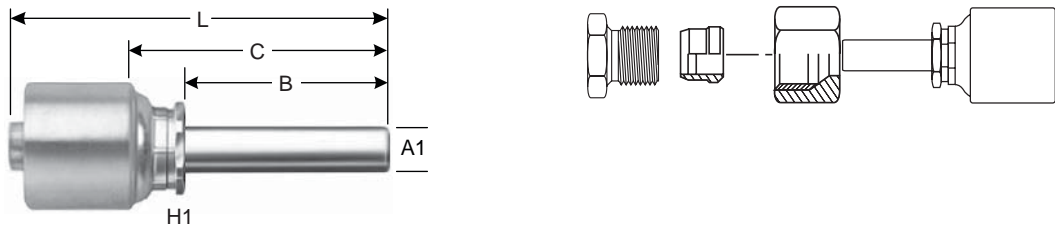

Descr.	Prod. No.	⌀		H1	L		C		B		A1	Std. Pack
		"	mm		"	mm	"	mm	"	mm		
STANDARD PACK												
4G-6MSP	7100-93355	1/4	6.4	1/2	2.24	57.0	1.22	31.0	.87	22.0	6.0	1
4G-8MSP	7100-93365	1/4	6.4	1/2	2.24	57.0	1.22	31.0	.87	22.0	8.0	1
4G-10MSP	7100-93375	1/4	6.4	1/2	2.54	64.5	1.51	38.5	.87	22.0	8.0	1
6G-10MSP	7100-90325	3/8	9.5	5/8	2.34	59.5	1.24	31.6	.91	23.0	10.0	1
6G-12MSP	7100-90005	3/8	9.5	5/8	2.34	59.5	1.24	31.6	.91	23.0	12.0	1
8G-15MSP	7100-90045	1/2	12.7	13/16	2.81	71.5	1.34	34.0	.98	25.0	15.0	1



- EQUIPMENT
- HOSE/CPLG. SELECTION
- GLOBAL SPIRAL COUPLINGS
- PCM/PCS FERRULES
- MEGACRIMP COUPLINGS**
- POWER CRIMP COUPLINGS
- LOW PRESSURE COUPLINGS
- POLARSEAL COUPLINGS
- C14 COUPLINGS
- PCTS THERMO-PLASTIC COUPLINGS
- FIELD ATTACHABLE G1 & G2 COUPLINGS
- FIELD ATTACHABLE C5 COUPLINGS
- SURELOK AIR BRAKE COUPLINGS
- QUICK DISCONNECT COUPLERS
- NEW BALL VALVES
- ACCESSORIES
- EQUIPMENT AND PARTS



MegaCrimp® Couplings

EQUIPMENT

HOSE/CPLG. SELECTION

GLOBALSPIRAL COUPLINGS

PCM/PCS FERRULES

MEGACRIMP COUPLINGS

POWER CRIMP COUPLINGS

LOW PRESSURE COUPLINGS

POLARSEAL COUPLINGS

C14 COUPLINGS

PCTS THERMO-PLASTIC COUPLINGS

FIELD ATTACHABLE G1 & G2 COUPLINGS

FIELD ATTACHABLE C5 COUPLINGS

SURELOK AIR BRAKE COUPLINGS

QUICK DISCONNECT COUPLERS

NEW BALL VALVES

ACCESSORIES

EQUIPMENT AND PARTS

Metric Light Stand Pipe - Cont'd

Descr.	Prod. No.	⊖		H1	L		C		B		A1	Std. Pack
		"	mm	"	"	mm	"	mm	"	mm	mm	
10G-18MSP	7100-93405	5/8	15.8	15/16	3.04	77.2	1.56	39.7	.98	25.0	18.0	1
10G-22MSP	7100-95335	5/8	15.8	15/16	3.11	79.0	1.63	41.5	.98	25.0	22.0	1
12G-18MSP	7100-95345	3/4	19.0	1 1/16	3.44	87.5	1.44	36.5	1.02	26.0	18.0	1
12G-22MSP	7100-93465	3/4	19.0	1 1/16	3.50	89.0	1.50	38.0	1.10	28.0	22.0	1
16G-28MSP	7100-95355	1	25.4	1 7/16	3.90	99.0	1.66	42.2	1.18	30.0	28.0	1

Metric Bite Sleeve



Descr.	Prod. No.	A1	Std. Pack
		mm	
STANDARD PACK			
6BS	7253-26815	6.0	5
8BS	7253-26835	8.0	5
10BS	7253-26855	10.0	1
12BS	7253-26875	12.0	1
14BS	7253-26895	14.0	1
15BS	7253-26905	15.0	1
16BS	7253-26915	16.0	1
18BS	7253-26925	18.0	1
20BS	7253-26935	20.0	1
22BS	7253-26945	22.0	1
25BS	7253-26955	25.0	1
28BS	7253-26965	28.0	1
30BS	7253-26975	30.0	1
35BS	7253-26985	35.0	1
38BS	7253-26995	38.0	1
42BS	7253-27005	42.0	1

Metric Bite Nut

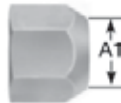

Descr.	Prod. No.		A1	Std. Pack
			mm	
STANDARD PACK				
6MNH	7253-27115	M14X1.5	6.0	5
6MNL	7253-27105	M12X1.5	6.0	5
8MNH	7253-27135	M16X1.5	8.0	5
8MNL	7253-27125	M14X1.5	8.0	5
10MNH	7253-27155	M18X1.5	10.0	1
10MNL	7253-27145	M16X1.5	10.0	1
12MNH	7253-27175	M20X1.5	12.0	1
12MNL	7253-27165	M18X1.5	12.0	1
14MNH	7253-27195	M22X1.5	15.0	1
15MNL	7253-27185	M22X1.5	14.0	1





Metric Bite Nut - Cont'd

Descr.	Prod. No.		A1	Std. Pack
			mm	
16MNH	7253-27205	M24X1.5	16.0	1
18MNL	7253-27215	M26X1.5	18.0	1
20MNH	7253-27225	M30X1.5	20.0	1
22MNL	7253-27235	M30X1.5	22.0	1
25MNH	7253-27245	M36X1.5	25.0	1
28MNL	7253-27255	M36X1.5	28.0	1
30MNH	7253-27265	M42X1.5	30.0	1
35MNL	7253-27275	M45X1.5	35.0	1
38MNH	7253-27285	M52X1.5	38.0	1
42MNL	7253-27295	M52X1.5	42.0	1

Male British Standard Pipe Tapered/Japanese Tapered Thread

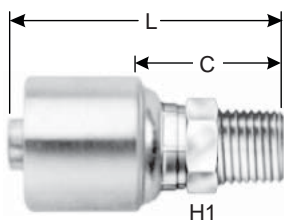

H1

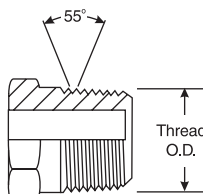

BSPT Male

Descr.	Prod. No.	⊖			H1	H2	L		C		Std. Pack
		"	mm				"	mm	"	mm	
STANDARD PACK											
4G-4MBSPT	7100-91075	1/4	6.4	1/4-19	14.0	—	1.89	47.9	.97	24.8	1
6G-6MBSPT	7100-91105	3/8	9.5	3/8-19	19.0	—	1.95	49.5	1.03	26.1	1
8G-8MBSPT	7100-91125	1/2	12.7	1/2-14	22.0	—	2.49	63.4	1.22	30.9	1
12G-12MBSPT	7100-91145	3/4	19.0	3/4-14	32.0	—	2.92	74.1	1.41	35.7	1
16G-16MBSPT	7100-91155	1	25.4	1-11	36.0	—	3.44	87.5	1.64	41.6	1

Male British Standard Parallel Pipe

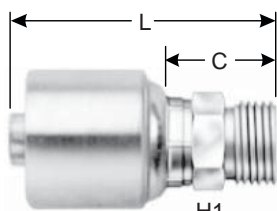

H1

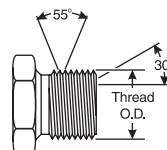

Descr.	Prod. No.	⊖			H1	H2	L		C		Std. Pack
		"	mm				"	mm	"	mm	
STANDARD PACK											
4G-4MBSPP	7100-15515	1/4	6.4	1/4-19	19.0	—	2.11	53.5	1.08	27.5	1
6G-4MBSPP	7100-98255	3/8	9.5	1/4-19	19.0	—	2.04	52.0	.94	24.1	1
6G-6MBSPP	7100-15525	3/8	9.5	3/8-19	22.0	—	2.17	55.0	1.07	27.1	1
6G-8MBSPP	7100-15535	3/8	9.5	1/2-14	27.0	—	2.36	60.0	1.26	32.1	1
8G-6MBSPP	7100-93245	1/8	12.7	3/8-19	22.0	—	2.30	58.5	1.02	26.0	1

EQUIPMENT

HOSE/CPLG. SELECTION

GLOBAL SPIRAL COUPLINGS

PCM/PCS FERRULES

MEGACRIMP COUPLINGS

POWER CRIMP COUPLINGS

LOW PRESSURE COUPLINGS

POLAR SEAL COUPLINGS

C14 COUPLINGS

PCTS THERMO-PLASTIC COUPLINGS

FIELD ATTACHABLE G1 & G2 COUPLINGS

FIELD ATTACHABLE C5 COUPLINGS

SURELOK AIR BRAKE COUPLINGS

QUICK DISCONNECT COUPLERS

NEW BALL VALVES

ACCESSORIES

EQUIPMENT AND PARTS



MegaCrimp® Couplings





Male British Standard Parallel Pipe - Cont'd

Descr.	Prod. No.	⊖			H1	H2	L		C		Std. Pack
		"	mm				"	mm	"	mm	
8G-8MBSPP	7100-05545	1/2	12.7	1/2-14	27.0	—	2.72	69.0	1.24	31.5	1
10G-10MBSPP	7100-05555	5/8	15.8	5/8-14	30.0	—	2.89	73.5	1.41	36.0	1
12G-12MBSPP	7100-05565	3/4	19.0	3/4-14	32.0	—	3.35	85.0	1.34	34.0	1
16G-16MBSPP	7100-05575	1	25.4	1-11	41.0	—	3.98	101.0	1.74	44.2	1
20G-20MBSPP	7100-05585	1 1/4	31.8	1 1/4-11	50.0	—	4.33	110.0	2.00	51.0	1

Female British Standard Parallel Pipe O-Ring Swivel

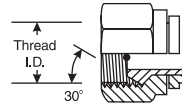
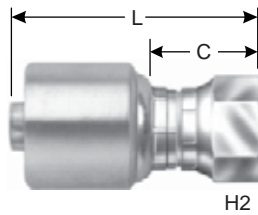
Includes O-Ring sealing in flare.



Descr.	Prod. No.	⊖			H1	H2	L		C		Std. Pack
		"	mm				"	mm	"	mm	
STANDARD PACK											
4G-2FBSPX	7100-93285	1/4	6.4	1/8-28	—	14.0	1.62	41.1	.71	18.0	1
4G-4FBSPORX	7100-94175	1/4	6.4	1/4-19	—	19.0	1.57	39.9	.67	17.0	1
4G-6FBSPORX	7100-94185	1/4	6.4	3/8-19	—	22.0	1.57	39.9	.67	17.0	1
5G-6FBSPORX	7100-94195	5/16	7.9	3/8-19	—	22.0	1.66	42.2	.71	18.1	1
5G-8FBSPORX	7100-94205	5/16	7.9	1/2-14	—	27.0	2.16	54.8	1.06	26.8	1
6G-6FBSPORX	7100-94215	3/8	9.5	3/8-19	—	22.0	1.61	41.0	.70	17.9	1
6G-8FBSPORX	7100-94225	3/8	9.5	1/2-14	—	27.0	1.58	40.2	.67	17.1	1
8G-6FBSPORX	7100-94235	1/2	12.7	3/8-19	—	22.0	2.62	66.5	1.14	29.0	1
8G-8FBSPORX	7100-94245	1/2	12.7	1/2-14	—	27.0	2.53	64.2	1.05	26.7	1
8G-10FBSPORX	7100-94255	1/2	12.7	5/8-14	—	27.0	2.68	68.0	1.20	30.5	1
10G-10FBSPORX	7100-94265	5/8	15.8	5/8-14	—	30.0	1.92	48.8	.75	19.1	1
10G-12FBSPORX	7100-94275	5/8	15.8	3/4-14	—	32.0	1.99	50.5	.82	20.8	1
12G-12FBSPORX	7100-94285	3/4	19.0	3/4-14	—	32.0	2.34	59.5	.83	21.0	1
12G-16FBSPORX	7100-94295	3/4	19.0	1-11	—	41.0	3.43	87.0	1.42	36.0	1
16G-16FBSPORX	7100-94305	1	25.4	1-11	—	41.0	2.76	70.1	.99	25.2	1
20G-20FBSPORX	7100-94315	1 1/4	31.7	1 1/4-11	—	50.0	2.97	75.5	1.16	29.5	1
BULK PACK											
4G-4FBSPORX XBULK	7100-9417	1/4	6.4	1/4-19	—	19.0	1.57	39.9	.67	17.0	200
6G-6FBSPORX XBULK	7100-9421	3/8	9.5	3/8-19	—	22.0	1.61	41.0	.70	17.9	200
8G-8FBSPORX XBULK	7100-9424	1/2	12.7	1/2-14	—	27.0	2.53	64.2	1.05	26.7	100
10G-10FBSPORX XBULK	7100-9426	5/8	15.8	5/8-14	—	30.0	1.92	48.8	.75	19.1	70
12G-12FBSPORX XBULK	7100-9428	3/4	19.0	3/4-14	—	32.0	2.34	59.5	.83	21.0	60
16G-16FBSPORX XBULK	7100-9430	1	25.4	1-11	—	41.0	2.76	70.1	.99	25.2	25





Female British Standard Parallel Pipe O-Ring Swivel - 45° Bent Tube

Includes O-Ring sealing in flare.

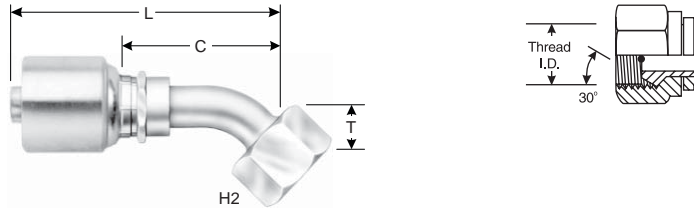

Descr.	Prod. No.	⊖		🌀	H1	H2	T		L		C		Std. Pack
		"	mm				"	mm	"	mm	"	mm	
STANDARD PACK													
4G-4FBSPORX45	7100-91445	1/4	6.4	1/4-19	—	19.0	.46	11.6	2.13	54.0	1.22	31.1	1
6G-6FBSPORX45	7100-91475	3/8	9.5	3/8-19	—	22.0	.61	15.4	2.44	62.1	1.54	39.1	1
6G-8FBSPORX45	7100-91485	3/8	9.5	1/2-14	—	27.0	.76	19.3	2.60	66.1	1.69	43.0	1
8G-8FBSPORX45	7100-91495	1/2	12.7	1/2-14	—	27.0	.67	17.0	3.01	76.5	1.73	44.0	1
10G-10FBSPORX45	7100-91505	5/8	15.9	3/4-14	—	30.0	.84	21.3	3.22	81.8	2.05	52.1	1
12G-12FBSPORX45	7100-91525	3/4	19.0	3/4-14	—	32.0	1.11	28.3	4.05	102.9	2.54	64.4	1
16G-16FBSPORX45	7100-91535	1	25.4	1-11	—	41.0	1.22	30.9	4.87	123.6	3.10	78.8	1
20G-20FBSPORX45	7100-92715	1 1/4	31.7	1 1/4-11	—	50.0	1.48	37.5	5.50	139.6	3.68	93.4	1

Female British Standard Parallel Pipe O-Ring Swivel - 90° Bent Tube

Includes O-Ring sealing in flare.

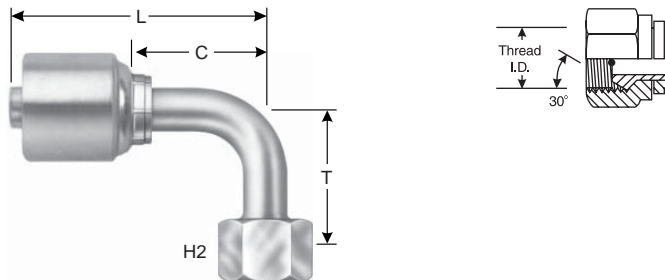

Descr.	Prod. No.	⊖		🌀	H1	H2	T		L		C		Std. Pack
		"	mm				"	mm	"	mm	"	mm	
STANDARD PACK													
4G-4FBSPORX90	7100-91545	1/4	6.4	1/4-19	—	19.0	.93	23.5	1.94	49.4	1.04	26.5	1
6G-6FBSPORX90	7100-91575	3/8	9.5	1/2-14	—	22.0	1.26	32.0	2.24	57.0	1.34	34.0	1
6G-8FBSPORX90	7100-91585	3/8	9.5	3/8-19	—	22.0	1.26	32.0	2.24	57.0	1.34	34.0	1
8G-8FBSPORX90	7100-91595	1/2	12.7	1/2-14	—	27.0	1.48	37.5	2.87	73.0	1.59	40.5	1
8G-10FBSPORX90	7100-93145	1/2	12.7	5/8-14	—	30.0	1.81	46.0	3.00	76.3	1.83	46.6	1
10G-10FBSPORX90	7100-91605	5/8	15.9	5/8-14	—	30.0	1.81	46.0	3.00	76.3	1.83	46.6	1
12G-12FBSPORX90	7100-91625	3/4	19.0	3/4-14	—	32.0	2.36	60.0	3.72	94.5	2.20	56.0	1
16G-16FBSPORX90	7100-91635	1	25.4	1-11	—	41.0	2.76	70.0	4.69	119.2	2.93	74.3	1
20G-20FBSPORX90	7100-91645	1 1/4	31.7	1 1/4-11	—	50.0	3.15	80.0	5.07	128.8	3.26	82.8	1
BULK PACK													
4G-4FBSPORX90XBULK	7100-9154	1/4	6.4	1/4-19	—	19.0	.93	23.5	1.94	49.4	1.04	26.5	200
6G-6FBSPORX90XBULK	7100-9157	3/8	9.5	1/2-14	—	22.0	1.26	32.0	2.24	57.0	1.34	34.0	150



EQUIPMENT

HOSE/CPLG. SELECTION

GLOBALSPIRAL COUPLINGS

PCM/PCS FERRULES

MEGACRIMP COUPLINGS

POWER CRIMP COUPLINGS

LOW PRESSURE COUPLINGS

POLARSEAL COUPLINGS

C14 COUPLINGS

PCTS THERMO-PLASTIC COUPLINGS

FIELD ATTACHABLE G1 & G2 COUPLINGS

FIELD ATTACHABLE C5 COUPLINGS

SURELOK AIR BRAKE COUPLINGS

QUICK DISCONNECT COUPLERS

NEW BALL VALVES

ACCESSORIES

EQUIPMENT AND PARTS



MegaCrimp® Couplings

EQUIPMENT

HOSE/CPLG. SELECTION

GLOBAL SPIRAL COUPLINGS

PCM/PCS FERRULES

MEGACRIMP COUPLINGS

POWER CRIMP COUPLINGS

LOW PRESSURE COUPLINGS

POLARSEAL COUPLINGS

C14 COUPLINGS

PCTS THERMO-PLASTIC COUPLINGS

FIELD ATTACHABLE G1 & G2 COUPLINGS

FIELD ATTACHABLE C5 COUPLINGS

SURELOK AIR BRAKE COUPLINGS

QUICK DISCONNECT COUPLERS

NEW BALL VALVES

ACCESSORIES

EQUIPMENT AND PARTS

Female British Standard Parallel Pipe O-Ring Swivel - 90° Bent Tube - Cont'd

Descr.	Prod. No.	⊖			H1	H2	T		L		C		Std. Pack
		"	mm		mm	mm	"	mm	"	mm	"	mm	
8G-8FBSPORX90XBULK	7100-9159	1/2	12.7	1/2-14	—	27.0	1.48	37.5	2.87	73.0	1.59	40.5	100
12G-12FBSPORX90XBULK	7100-9162	3/4	19.0	3/4-14	—	32.0	2.36	60.0	3.72	94.5	2.20	56.0	40
16G-16FBSPORX90XBULK	7100-9163	1	25.4	1-11	—	41.0	2.76	70.0	4.69	119.2	2.93	74.3	25

Female British Standard Parallel Pipe O-Ring Swivel - 90° Block

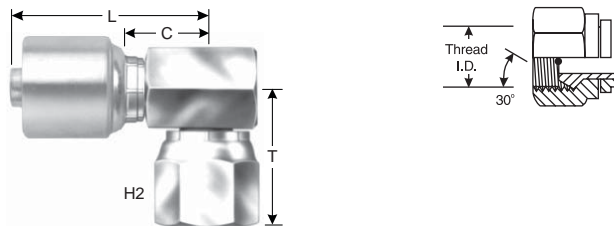

Descr.	Prod. No.	⊖			H1	H2	T		L		C		Std. Pack
		"	mm		"	"	"	mm	"	mm	"	mm	
STANDARD PACK													
4G-4FBSPORX90BL	7100-91825	1/4	6.4	1/4-19	—	3/4	.71	18.0	1.63	41.4	.72	18.2	1
6G-6FBSPORX90BL	7100-91835	3/8	9.5	3/8-19	—	7/8	.83	21.0	1.71	43.5	.79	20.0	1
8G-8FBSPORX90BL	7100-91845	1/2	12.7	1/2-14	—	1 1/16	.94	24.0	2.20	55.9	.93	23.5	1

Female British Flat-Face Swivel

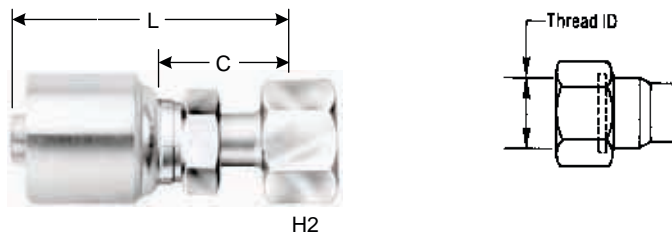

Descr.	Prod. No.	⊖			H1	H2	L		C		Std. Pack
		"	mm		mm	mm	"	mm	"	mm	
STANDARD PACK											
6G-6FBFFX	7100-93715	3/8	9.5	3/8-19	—	24.0	1.67	40.5	.68	16.9	1
6G-8FBFFX	7100-93725	3/8	9.5	1/2-14	—	27.0	1.79	45.5	.69	17.6	1
8G-8FBFFX	7100-93735	1/2	12.7	1/2-14	—	27.0	2.19	55.5	.71	18.0	1
8G-12FBFFX	7100-93745	1/2	12.7	3/4-14	—	32.0	2.07	52.5	.59	15.0	1



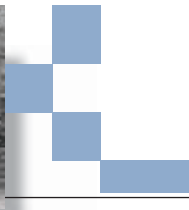

Komatsu O-Ring Flange - Straight

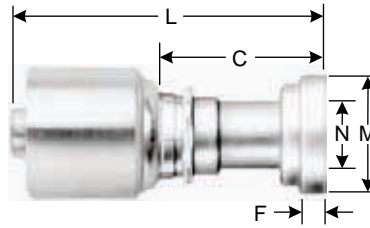

Descr.	Prod. No.	⊖		N		M		L		C		F		Std. Pack
		"	mm	"	"	mm	"	mm	"	mm	"	mm	"	
STANDARD PACK														
8G-10FLK	7100-03805	1/2	12.7	5/8	1.35	34.2	3.15	80.0	1.67	42.5	.27	6.7	1	
10G-10FLK	7100-03825	5/8	15.8	5/8	1.35	34.2	4.69	119.0	3.21	81.5	.27	6.7	1	

Komatsu O-Ring Flange - 45° Bent Tube

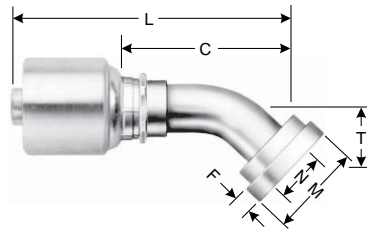

Descr.	Prod. No.	⊖		N		M		T		L		C		F		Std. Pack
		"	mm	"	"	mm	"	mm	"	mm	"	mm	"	mm		
STANDARD PACK																
10G-10FLK45	7100-04155	5/8	15.8	5/8	1.35	34.1	1.02	26.0	4.19	106.5	2.72	69.0	.27	6.9	1	

Komatsu O-Ring Flange - 90° Bent Tube

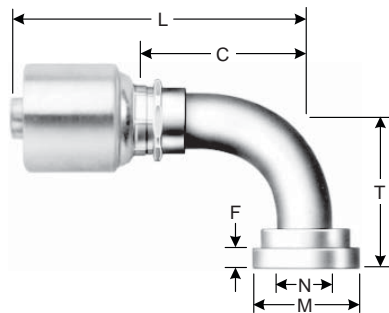

Descr.	Prod. No.	⊖		N		M		T		L		C		F		Std. Pack
		"	mm	"	"	mm	"	mm	"	mm	"	mm	"	mm		
STANDARD PACK																
10G-10FLK90	7100-04475	5/8	15.9	5/8	1.35	34.1	2.17	55.0	3.90	99.0	2.42	61.5	.27	6.9	1	

EQUIPMENT

HOSE/CPLG. SELECTION

GLOBALSPIRAL COUPLINGS

PCM/PCS FERRULES

MEGACRIMP COUPLINGS

POWER CRIMP COUPLINGS

LOW PRESSURE COUPLINGS

POLARSEAL COUPLINGS

C14 COUPLINGS

PCTS THERMO-PLASTIC COUPLINGS

FIELD ATTACHABLE G1 & G2 COUPLINGS

FIELD ATTACHABLE C5 COUPLINGS

SURELOK AIR BRAKE COUPLINGS

QUICK DISCONNECT COUPLERS

NEW BALL VALVES

ACCESSORIES

EQUIPMENT AND PARTS



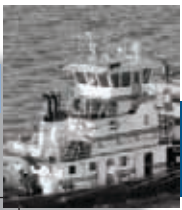

MegaCrimp® Couplings

Female Komatsu Style Japanese Metric Swivel

These female swivels have been marked with two small notches on the hex to identify them as the Komatsu style.

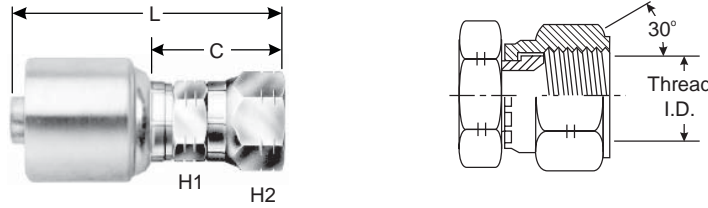

DESCR.	PROD. NO.	Ø		SPRING	H1	H2	L		C		STD. PACK
		"	mm		"	"	"	mm	"	mm	
STANDARD PACK											
4G-4FKX	7100-03625	1/4	6.4	M14X1.5	9/16	3/4	2.22	56.3	1.19	30.2	1
4G-6FKX	7100-03635	1/4	6.4	M18X1.5	11/16	7/8	2.41	61.3	1.39	35.3	1
6G-6FKX	7100-03645	3/8	9.5	M18X1.5	11/16	7/8	2.47	62.8	1.37	34.9	1
8G-8FKX	7100-03655	1/2	12.7	M22X1.5	7/8	1 1/16	2.93	74.5	1.46	37.0	1
10G-10FKX	7100-03665	5/8	15.8	M24X1.5	1	1 1/4	3.09	78.5	1.62	41.1	1
12G-12FKX	7100-03675	3/4	19.0	M30X1.5	1 1/8	1 7/8	3.82	97.1	1.81	46.1	1
16G-16FKX	7100-03685	1	25.4	M33X1.5	1 3/8	1 5/8	4.51	114.6	2.28	57.8	1
BULK PACK											
4G-4FKX XBULK	7100-0362	1/4	6.4	M14X1.5	9/16	3/4	2.22	56.3	1.19	30.2	200
6G-6FKX XBULK	7100-0364	3/8	9.5	M18X1.5	11/16	7/8	2.47	62.8	1.37	34.9	200
8G-8FKX XBULK	7100-0365	1/2	12.7	M22X1.5	7/8	1 1/16	2.93	74.5	1.46	37.0	100
10G-10FKX XBULK	7100-0366	5/8	15.8	M24X1.5	1	1 1/4	3.09	78.5	1.62	41.1	100
12G-12FKX XBULK	7100-0367	3/4	19.0	M30X1.5	1 1/8	1 7/8	3.82	97.1	1.81	46.1	60
16G-16FKXXBULK	7100-0368	1	25.4	M33X1.5	1 3/8	1 5/8	4.51	114.6	2.28	57.8	25

Female Komatsu Style Japanese Metric Swivel - 45° Bent Tube

These female swivels have been marked with two small notches on the hex to identify them as the Komatsu style.

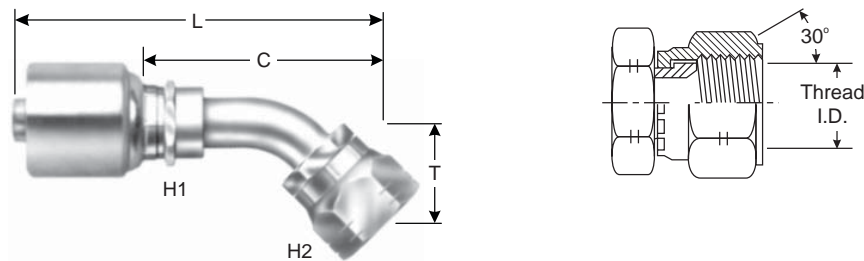

DESCR.	PROD. NO.	Ø		SPRING	H1	H2	T	L		C		STD. PACK	
		"	mm		"	"	"	mm	"	mm			
STANDARD PACK													
4G-4FKX45	7100-03035	1/4	6.4	M14X1.5	1/2	3/4	.75	19.0	3.07	78.0	2.05	52.2	1
6G-6FKX45	7100-03045	3/8	9.5	M18X1.5	5/8	7/8	1.10	28.0	3.39	86.0	2.29	58.1	1
8G-8FKX45	7100-03055	1/2	12.7	M22X1.5	13/16	1 1/16	.71	18.0	3.74	95.0	2.26	57.5	1
10G-10FKX45	7100-03065	5/8	15.8	M24X1.5	15/16	1 1/4	1.10	28.0	4.43	112.5	2.95	75.0	1
12G-12FKX45	7100-03075	3/4	19.0	M14X1.5	1/2	3/4	.75	19.0	3.07	78.0	2.05	52.0	1





Female Komatsu Style Japanese Metric Swivel - 90° Bent Tube

These female swivels have been marked with two small notches on the hex to identify them as the Komatsu style.

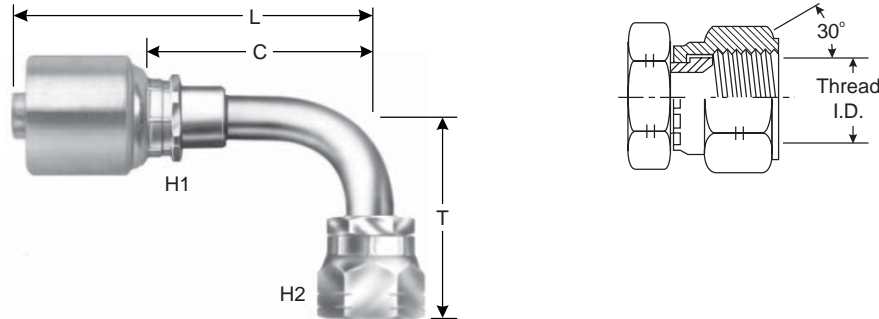

Descr.	Prod. No.	⌀		Spring	H1	H2	T		L		C		Std. Pack
		"	mm				"	mm	"	mm	"	mm	
STANDARD PACK													
4G-4FKX90	7100-03125	1/4	6.4	M14X1.5	1/2	3/4	1.50	38.0	2.72	69.0	1.69	43.0	1
6G-6FKX90	7100-03135	3/8	9.5	M18X1.5	5/8	7/8	1.09	27.7	2.92	74.2	1.82	46.3	1
8G-8FKX90	7100-03145	1/2	12.7	M22X1.5	13/16	1 1/16	1.38	35.0	3.46	88.0	1.99	50.5	1
10G-10FKX90	7100-06795	5/8	15.8	M24X1.5	15/16	1 1/4	2.57	65.3	3.43	87.0	1.95	49.5	1
12G-12FKX90	7100-03165	3/4	19.0	M30X1.5	1 1/16	1 7/16	2.48	63.0	4.65	188.0	2.64	67.0	1

Female Japanese Industrial Standard Swivel

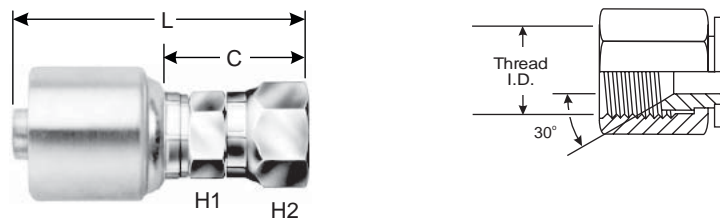

Descr.	Prod. No.	⌀		Spring	H1	H2	L		C		Std. Pack
		"	mm				mm	mm	"	mm	
STANDARD PACK											
4G-4FJISX	7100-03305	1/4	6.4	1/4-19	19.0	19.0	2.20	56.0	1.18	30.0	1
6G-6FJISX	7100-03325	3/8	9.5	3/8-19	16.0	22.0	2.38	60.5	1.28	32.5	1
8G-8FJISX	7100-03345	1/2	12.7	1/2-14	20.0	27.0	2.93	74.5	1.46	37.0	1
12G-12FJISX	7100-03365	3/4	19.0	3/4-14	27.0	32.0	3.67	93.3	1.67	42.3	1
16G-16FJISX	7100-03385	1	25.4	1-11	35.0	38.0	4.08	103.6	1.84	46.8	1
20G-20FJISX	7100-03405	1 1/4	31.7	1 1/4-11	44.5	50.8	4.59	116.5	2.26	57.5	1
BULK PACK											
4G-4FJISXBULK	7100-0330	1/4	6.4	1/4-19	19.0	19.0	2.20	56.0	1.18	30.0	200
6G-6FJISXBULK	7100-0332	3/8	9.5	3/8-19	16.0	22.0	2.38	60.5	1.28	32.5	200
8G-8FJISXBULK	7100-0334	1/2	12.7	1/2-14	20.0	27.0	2.93	74.5	1.46	37.0	100
12G12FJISXBULK	7100-0336	3/4	19.0	3/4-14	27.0	32.0	3.67	93.3	1.67	42.3	70

EQUIPMENT
HOSE/CPLG. SELECTION
GLOBAL SPIRAL COUPLINGS
PCM/PCS FERRULES
MEGACRIMP COUPLINGS
POWER CRIMP COUPLINGS
LOW PRESSURE COUPLINGS
POLARSEAL COUPLINGS
C14 COUPLINGS
PCTS THERMO-PLASTIC COUPLINGS
FIELD ATTACHABLE G1 & G2 COUPLINGS
FIELD ATTACHABLE C5 COUPLINGS
SURELOK AIR BRAKE COUPLINGS
QUICK DISCONNECT COUPLERS
NEW BALL VALVES
ACCESSORIES
EQUIPMENT AND PARTS

