

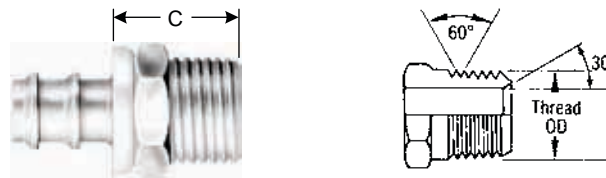

# Brass Field Attachable Couplings for Lock-On





## Male Pipe (NPTF - 30° Cone Seat)

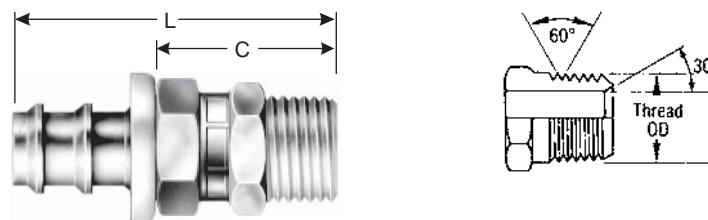

Descr.	Prod. No.	⊖			C		Std. Pack
		"	mm		"	mm	
<b>STANDARD PACK</b>							
4LOC-2RMP	7207-06545	1/4	6.4	1/8-27	.56	14.2	1
4LOC-4RMP	7207-06555	1/4	6.4	1/4-18	.81	20.6	1
4LOC-6RMP	7250-16065	1/4	6.4	3/8-18	.88	22.4	1
5LOC-2RMP	7207-86515	5/16	7.9	1/8-27	.81	20.6	1
5LOC-4RMP	7207-86516	5/16	7.9	1/4-18	.77	19.6	1
6LOC-2RMP	7207-10015	3/8	9.5	1/8-27	.56	14.2	1
6LOC-4RMP	7207-06565	3/8	9.5	1/4-18	.81	20.6	1
6LOC-6RMP	7207-06575	3/8	9.5	3/8-18	.88	22.4	1
6LOC-8RMP	7250-16075	3/8	9.5	1/2-14	.88	22.4	1
8LOC-4RMP	7250-16085	1/2	12.7	1/4-18	.81	20.6	1
8LOC-6RMP	7207-06585	1/2	12.7	3/8-18	.88	22.4	1
8LOC-8RMP	7207-06595	1/2	12.7	1/2-14	.88	22.4	1
8LOC-12RMP	7250-16095	1/2	12.7	3/4-14	1.13	28.7	1
10LOC-6RMP	7250-16105	5/8	15.8	3/8-18	.88	22.4	1
10LOC-8RMP	7207-86507	5/8	15.9	1/2-14	1.06	26.9	1
10LOC-12RMP	7250-16115	5/8	15.8	3/4-14	.88	28.7	1
12LOC-8RMP	7250-16125	3/4	19.0	1/2-14	.88	22.4	1
12LOC-12RMP	7207-06625	3/4	19.0	3/4-14	1.13	28.7	1
<b>BULK PACK</b>							
4LOC-2RMPXBULK	7207-0654	1/4	6.4	1/8-27	.56	14.2	100
4LOC-4RMPXBULK	7207-0655	1/4	6.4	1/4-18	.81	20.6	100
6LOC-4RMPXBULK	7207-0656	3/8	9.5	1/4-18	.81	20.6	100
6LOC-6RMPXBULK	7207-0657	3/8	9.5	3/8-18	.88	22.4	100
8LOC-6RMPXBULK	7207-0658	1/2	12.7	3/8-18	.88	22.4	100
8LOC-8RMPXBULK	7207-0659	1/2	12.7	1/2-14	.88	22.4	100
12LOC-12RMPXBULK	7207-0662	3/4	19.0	3/4-14	1.13	28.7	100

## Male Pipe Swivel (NPTF - Without 30° Cone Seat)



Descr.	Prod. No.	⊖			C		Std. Pack
		"	mm		"	mm	
<b>STANDARD PACK</b>							
4LOC-4RMPX	7250-16135	1/4	6.3	1/4-18	1.81	46.0	1

EQUIPMENT
HOSE/CPLG. SELECTION
GLOBALSPIRAL COUPLINGS
PCM/PCS FERRULES
MEGACRIMP COUPLINGS
POWER CRIMP COUPLINGS
LOW PRESSURE COUPLINGS
POLARSEAL COUPLINGS
C14 COUPLINGS
PCTS THERMO-PLASTIC COUPLINGS
FIELD ATTACHABLE G1 & G2 COUPLINGS
FIELD ATTACHABLE C5 COUPLINGS
SURELOK AIR BRAKE COUPLINGS
QUICK DISCONNECT COUPLERS
NEW BALL VALVES
ACCESSORIES
EQUIPMENT AND PARTS





# Brass Field Attachable Couplings for Lock-On

EQUIPMENT

HOSE/CPLG. SELECTION

GLOBALSPIRAL COUPLINGS

PCM/PCS FERRULES

MEGACRIMP COUPLINGS

POWER CRIMP COUPLINGS

LOW PRESSURE COUPLINGS

POLARSEAL COUPLINGS

C14 COUPLINGS

PCTS THERMO-PLASTIC COUPLINGS

FIELD ATTACHABLE G1 & G2 COUPLINGS

FIELD ATTACHABLE C5 COUPLINGS

SURELOK AIR BRAKE COUPLINGS

QUICK DISCONNECT COUPLERS

NEW BALL VALVES

ACCESSORIES

EQUIPMENT AND PARTS

## Male Pipe Swivel (NPTF - Without 30° Cone Seat) - Cont'd

Descr.	Prod. No.	⊖			C		Std. Pack
		"	mm		"	mm	
6LOC-6RMPX	7250-16145	3/8	9.5	3/8-18	2.00	50.8	1
8LOC-8RMPX	7250-16155	1/2	12.7	1/4-14	2.38	60.5	1
12LOC-12RMPX	7250-16165	1/4	6.3	3/4-1/4	2.68	68.1	1

## Male Pipe - 90° Block (NPTF - Without 30° Cone Seat)

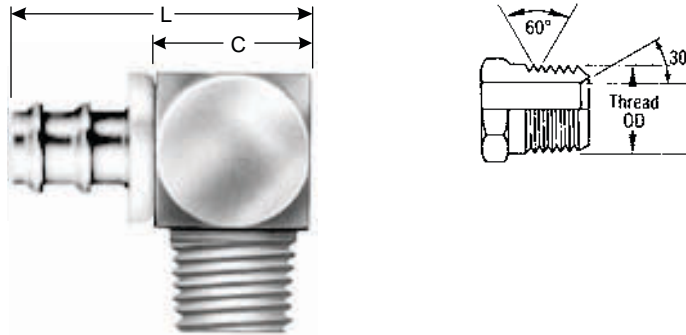

Descr.	Prod. No.	⊖			C		Std. Pack
		"	mm		"	mm	
<b>STANDARD PACK</b>							
4LOC-2RMP90	7207-10125	1/4	6.3	1/8-27	.31	7.9	1
4LOC-4RMP90	7250-16185	1/4	6.3	1/4-18	.38	9.7	1
6LOC-2RMP90	7207-10145	3/8	9.5	1/8-27	.38	9.7	1
6LOC-6RMP90	7207-10155	3/8	9.5	3/8-18	.43	10.9	1
8LOC-8RMP90	7250-16205	1/2	12.7	1/2-14	.50	12.7	1
12LOC-12RMP90	7250-16215	3/4	19.0	3/4-14	.76	19.3	1

## Female Pipe (NPTF - 30° Cone Seat)

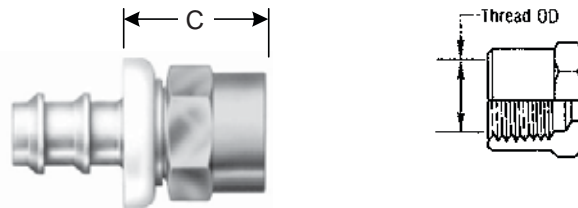

Descr.	Prod. No.	⊖			C		Std. Pack
		"	mm		"	mm	
<b>STANDARD PACK</b>							
4LOC-4RFP	7250-04595	1/4	6.3	1/4-18	.50	12.7	1
5LOC-4RFP	7250-16225	5/16	7.9	1/4-18	.50	12.7	1
6LOC-6RFP	7250-04605	3/8	9.5	3/8-18	.63	16.0	1
8LOC-6RFP	7250-16235	1/2	12.7	1/4-18	.63	16.0	1
10LOC-8RFP	7207-10235	5/8	15.8	1/2-14	.75	19.1	1
12LOC-12RFP	7207-10245	3/4	19.1	3/4-14	.93	23.6	1



# Brass Field Attachable Couplings for Lock-On



## Female Pipe Swivel (NPTF - Without 30° Cone Seat)

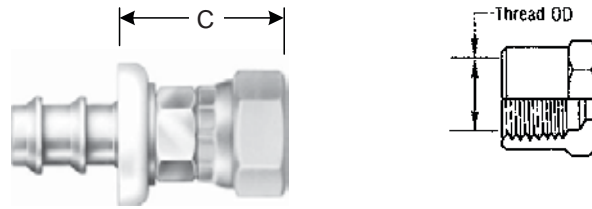

Descr.	Prod. No.	⊖			C		Std. Pack
		"	mm		"	mm	
<b>STANDARD PACK</b>							
4LOC-2RFPX	7250-16265	1/4	6.3	1/8-27	1.81	46.0	1
4LOC-4RFPX	7250-16275	1/4	6.3	1/4-18	1.81	46.0	1
4LOC-6RFPX	7250-16285	1/4	6.3	3/8-18	2.00	50.8	1
6LOC-4RFPX	7250-16295	3/8	9.5	1/4-18	1.81	46.0	1
6LOC-6RFPX	7250-16305	3/8	9.5	3/8-18	2.00	50.8	1
6LOC-8RFPX	7250-16315	3/8	9.5	1/2-14	2.38	60.5	1
8LOC-8RFPX	7250-16325	1/2	12.7	1/2-14	2.38	60.5	1
8LOC-12RFPX	7207-10325	1/2	12.7	3/4-14	2.68	68.1	1
10LOC-12RFPX	7207-10335	5/8	15.8	3/4-14	2.68	68.1	1
12LOC 12RFPX	7250-16355	3/4	19.1	3/4-14	2.68	68.1	1

## Male JIC 37° Flare

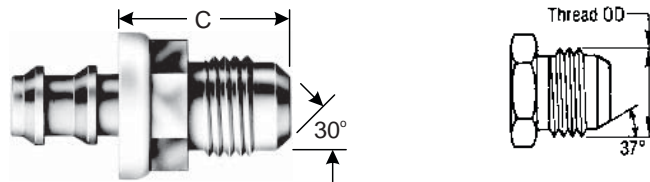

Descr.	Prod. No.	⊖			C		Std. Pack
		"	mm		"	mm	
<b>STANDARD PACK</b>							
4LOC-5RMJ	7250-16375	1/4	6.3	1/2-20	—	—	1
4LOC-6RMJ	7250-16385	1/4	6.3	9/16-18	—	—	1
6LOC-4RMJ	7250-16395	3/8	9.5	7/16-20	.88	22.4	1
6LOC-5RMJ	7207-10395	3/8	9.5	1/2-20	.94	23.9	1
6LOC-6RMJ	7250-16415	3/8	9.5	9/16-18	—	—	1
6LOC-8RMJ	7250-16425	3/8	9.5	3/4-16	1.19	30.2	1
8LOC-8RMJ	7207-10425	1/2	12.7	3/4-16	1.19	30.2	1
8LOC-10RMJ	7207-10435	1/2	12.7	7/8-14	1.27	32.3	1
10LOC-8RMJ	7207-10445	5/8	15.8	3/4-16	1.19	30.2	1
10LOC-10RMJ	7207-10455	5/8	15.8	7/8-14	1.27	32.3	1
12LOC-10RMJ	7207-10465	3/4	19.1	7/8-14	1.27	32.3	1

EQUIPMENT

HOSE/CPLG. SELECTION

GLOBALSPIRAL COUPLINGS

PCM/PCS FERRULES

MEGACRIMP COUPLINGS

POWER CRIMP COUPLINGS

LOW PRESSURE COUPLINGS

POLARSEAL COUPLINGS

C14 COUPLINGS

PCTS THERMO-PLASTIC COUPLINGS

FIELD ATTACHABLE G1 & G2 COUPLINGS

FIELD ATTACHABLE C5 COUPLINGS

SURELOK AIR BRAKE COUPLINGS

QUICK DISCONNECT COUPLERS

NEW BALL VALVES

ACCESSORIES

EQUIPMENT AND PARTS



The World's Most Trusted Name in Belts, Hose and Hydraulics.

[www.gates.com/hydraulics](http://www.gates.com/hydraulics)

H3



# Brass Field Attachable Couplings for Lock-On

## Female JIC 37° Flare Swivel

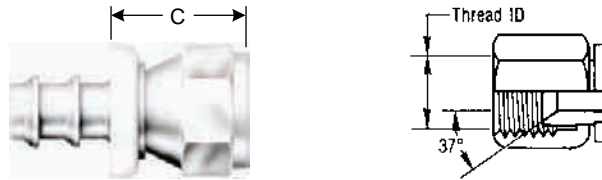

Descr.	Prod. No.	⊖			C		Std. Pack
		"	mm		"	mm	
<b>STANDARD PACK</b>							
4LOC-6RFJX	7250-16495	1/4	6.3	3/8-18	.74	18.8	1
6LOC-6RFJX	7207-06705	3/8	9.5	9/16-18	.81	20.6	1
6LOC-8RFJSX	7207-06785	3/8	9.5	3/4-16	.97	24.6	1
12LOC-12RFJX	7207-86536	3/4	19.0	1 1/16-12	1.09	27.7	1
<b>BULK PACK</b>							
6LOC-6RFJX XBULK	7207-0670	3/8	9.5	9/16-18	.81	20.6	100

## Male SAE 45° Flare

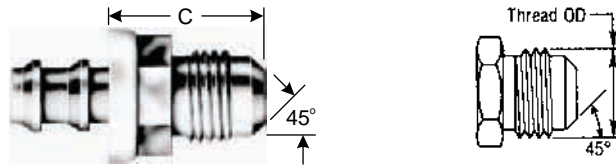

Descr.	Prod. No.	⊖			C		Std. Pack
		"	mm		"	mm	
<b>STANDARD PACK</b>							
4LOC-4RMS	7207-86511	1/4	6.4	7/16-20	.69	17.5	1
4LOC-5RMS	7207-86512	1/4	6.4	1/2-20	.38	9.7	1
4LOC-6RMS	7250-04665	1/4	6.3	5/8-18	.88	22.4	1
6LOC-4RMS	7207-10505	3/8	9.5	7/16-20	.69	17.5	1
6LOC-5RMS	7250-16515	3/8	9.5	1/2-20	.81	20.6	1
6LOC-6RMS	7207-86513	3/8	9.5	5/8-18	.88	22.4	1
6LOC-8RMS	7250-16525	3/8	9.5	3/4-16	1.31	28.7	1
8LOC-8RMS	7207-86514	1/2	12.7	3/4-16	1.13	28.7	1
8LOC-10RMS	7207-10535	1/2	12.7	7/8-14	1.27	32.3	1
10LOC-8RMS	7207-10545	5/8	15.8	3/4-16	1.13	28.7	1
10LOC-10RMS	7207-10555	5/8	15.8	7/8-14	1.27	32.3	1
12LOC-10RMS	7207-10565	3/4	19.1	7/8-14	1.27	32.3	1
12LOC-12RMS	7207-10575	3/4	19.1	1 1/16-14	1.83	33.8	1



# Brass Field Attachable Couplings for Lock-On



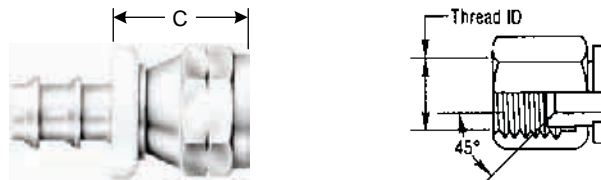

## Female SAE 45° Flare Swivel

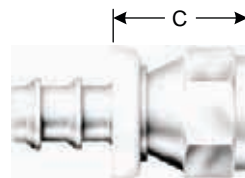

Descr.	Prod. No.	⊖			C		Std. Pack
		"	mm		"	mm	
<b>STANDARD PACK</b>							
4LOC-6RFSX	7250-16585	1/4	6.3	5/8-18	.69	17.5	1
5LOC-6RFSX	7207-86528	5/16	7.9	5/8-18	.81	20.6	1
6LOC-6RFSX	7207-06665	3/8	9.5	5/8-18	.84	21.3	1
8LOC-6RFSX	7207-10595	1/2	12.7	5/8-18	.84	21.3	1
12LOC-12RFSX	7207-86526	3/4	19.0	1 1/16-14	1.09	27.7	1
<b>BULK PACK</b>							
6LOC-6RFSX XBULK	7207-0666	3/8	9.5	5/8-18	.84	21.3	100

## Dual Seat Female JIC 37°/SAE 45° Flare Swivel



Descr.	Prod. No.	⊖			C		Std. Pack
		"	mm		"	mm	
<b>STANDARD PACK</b>							
4LOC-4RFJSX	7207-06635	1/4	6.4	7/16-20	.75	19.1	1
4LOC-5RFJSX	7207-06655	1/4	6.4	1/2-20	.78	19.8	1
5LOC-5RFJSX	7207-86527	5/16	7.9	1/2-20	.81	20.6	1
6LOC-5RFJSX	7250-04745	3/8	9.5	1/2-20	.81	20.6	1
8LOC-8RFJSX	7207-06725	1/2	12.7	3/4-16	.97	24.6	1
8LOC-10RFJSX	7207-07385	1/2	12.7	7/8-14	1.00	25.4	1
10LOC-10RFJSX	7207-86535	5/8	15.9	7/8-14	1.00	25.4	1
12LOC-10RFJSX	7250-04775	3/4	19.1	7/8-14	1.00	25.4	1
<b>BULK PACK</b>							
4LOC-4RFJSX XBULK	7207-0663	1/4	6.4	7/16-20	.75	19.1	100
4LOC-5RFJSX XBULK	7207-0665	1/4	6.4	1/2-20	.78	19.8	100

EQUIPMENT
HOSE/CPLG. SELECTION
GLOBALSPIRAL COUPLINGS
PCM/PCS FERRULES
MEGACRIMP COUPLINGS
POWER CRIMP COUPLINGS
LOW PRESSURE COUPLINGS
POLARSEAL COUPLINGS
C14 COUPLINGS
PCTS THERMO-PLASTIC COUPLINGS
FIELD ATTACHABLE G1 & G2 COUPLINGS
FIELD ATTACHABLE C5 COUPLINGS
SURELOK AIR BRAKE COUPLINGS
QUICK DISCONNECT COUPLERS
NEW BALL VALVES
ACCESSORIES
EQUIPMENT AND PARTS



# Brass Field Attachable Couplings for Lock-On



EQUIPMENT

HOSE/CPLG. SELECTION

GLOBALSPIRAL COUPLINGS

PCM/PCS FERRULES

MEGACRIMP COUPLINGS

POWER CRIMP COUPLINGS

LOW PRESSURE COUPLINGS

POLARSEAL COUPLINGS

C14 COUPLINGS

PCTS THERMO-PLASTIC COUPLINGS

FIELD ATTACHABLE G1 & G2 COUPLINGS

FIELD ATTACHABLE C5 COUPLINGS

SURELOK AIR BRAKE COUPLINGS

QUICK DISCONNECT COUPLERS

NEW BALL VALVES

ACCESSORIES

EQUIPMENT AND PARTS

## Male SAE Inverted Swivel

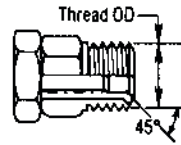
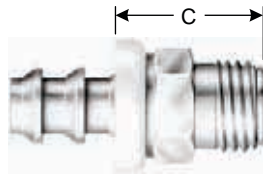

Descr.	Prod. No.	⊖			C		Std. Pack
		"	mm		"	mm	
<b>STANDARD PACK</b>							
4LOC-3RMIX	7207-86541	1/4	6.4	3/8-24	.78	19.8	1
4LOC-4RMIX	7207-06735	1/4	6.4	7/16-24	.78	19.8	1
4LOC-5RMIX	7207-06745	1/4	6.4	1/2-20	.78	19.8	1
5LOC-5RMIX	7207-86548	5/16	7.9	1/2-20	.82	20.8	1
5LOC-6RMIX	7207-86549	5/16	7.9	5/8-18	.86	21.8	1
6LOC-5RMIX	7250-04845	3/8	9.5	1/2-20	.82	20.8	1
6LOC-6RMIX	7207-06765	3/8	9.5	5/8-18	.97	24.6	1
6LOC-8RMIX	7250-16605	3/8	9.5	3/4-18	1.00	25.4	1
8LOC-8RMIX	7207-86545	1/2	12.7	3/4-16	1.00	25.4	1
10LOC-10RMIX	7207-86546	5/8	15.9	7/8-18	1.00	25.4	1
<b>BULK PACK</b>							
4LOC-4RMIX XBULK	7207-0673	1/4	6.4	7/16-24	.78	19.8	100
4LOC-5RMIX XBULK	7207-0674	1/4	6.4	1/2-20	.78	19.8	100
6LOC-6RMIX XBULK	7207-0676	3/8	9.5	5/8-18	.97	24.6	100

## Female SAE Inverted Solid

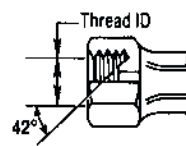
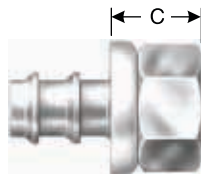

Descr.	Prod. No.	⊖			C		Std. Pack
		"	mm		"	mm	
<b>STANDARD PACK</b>							
4LOC-3RFI	7207-86551	1/4	6.4	3/8-24	.75	19.1	1
4LOC-4RFI	7207-86552	1/4	6.4	7/16-24	.75	19.1	1
4LOC-5RFI	7207-86553	1/4	6.4	1/2-20	.75	19.1	1
6LOC-5RFI	7207-10655	3/8	9.5	1/2-20	.75	19.1	1
6LOC-6RFI	7207-86554	3/8	9.5	5/8-18	.88	22.4	1
8LOC-8RFI	7207-10665	1/2	9.5	3/4-18	.93	23.6	1



# Brass Field Attachable Couplings for Lock-On



## SAE Stand Pipe

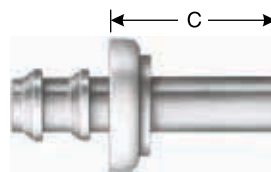

Descr.	Prod. No.	⊖			C		Std. Pack
		"	mm		"	mm	
<b>STANDARD PACK</b>							
8LOC-8RSP	7207-10675	1/2	12.7	1/2-14	1.00	25.4	1
10LOC-10RSP	7207-10685	5/8	15.9	7/8-14	1.00	25.4	1

## Hose Mender



Descr.	Prod. No.	⊖		Std. Pack
		"	mm	
<b>STANDARD PACK</b>				
4LOC-4RHM	7207-86571	1/4	6.4	1
5LOC-5RHM	7207-86575	5/16	7.9	1
6LOC-6RHM	7207-86572	3/8	9.5	1
8LOC-8RHM	7207-86573	1/2	12.7	1
10LOC-10RHM	7207-86574	5/8	15.9	1
12LOC-12RHM	7207-86577	3/4	19.0	1

## Flareless Tube Fitting (Compression Type)

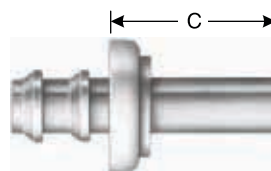

Descr.	Prod. No.	⊖		⊕		C		Std. Pack
		"	mm	"	mm	"	mm	
<b>STANDARD PACK</b>								
4LOC-3RFT	7207-86561	1/4	6.4	3/16	4.8	.75	19.1	1
4LOC-4RFT	7207-86562	1/4	6.4	1/4	6.3	1.00	25.4	1
4LOC-5RFT	7207-86563	1/4	6.3	5/16	0.3	1.13	28.7	1
6LOC-6RSP	7207-86564	3/8	9.5	3/8	9.5	1.25	31.8	1
8LOC-8RFT	7207-86565	1/2	12.7	1/2	12.7	1.00	25.4	1
10LOC-10RFT	7207-86566	5/8	15.9	5/8	15.9	1.00	25.4	1

EQUIPMENT
HOSE/CPLG. SELECTION
GLOBALSPIRAL COUPLINGS
PCM/PCS FERRULES
MEGACRIMP COUPLINGS
POWER CRIMP COUPLINGS
LOW PRESSURE COUPLINGS
POLARSEAL COUPLINGS
C14 COUPLINGS
PCTS THERMO-PLASTIC COUPLINGS
FIELD ATTACHABLE G1 & G2 COUPLINGS
FIELD ATTACHABLE C5 COUPLINGS
SURELOK AIR BRAKE COUPLINGS
QUICK DISCONNECT COUPLERS
NEW BALL VALVES
ACCESSORIES
EQUIPMENT AND PARTS





# GLP Couplings

EQUIPMENT
HOSE/CPLG. SELECTION
GLOBALSPIRAL COUPLINGS
PCM/PCS FERRULES
MEGACRIMP COUPLINGS
POWER CRIMP COUPLINGS
LOW PRESSURE COUPLINGS
POLARSEAL COUPLINGS
C14 COUPLINGS
PCTS THERMO-PLASTIC COUPLINGS
FIELD ATTACHABLE G1 & G2 COUPLINGS
FIELD ATTACHABLE C5 COUPLINGS
SURELOK AIR BRAKE COUPLINGS
QUICK DISCONNECT COUPLERS
NEW BALL VALVES
ACCESSORIES
EQUIPMENT AND PARTS

## Male Pipe (NPTF - 30° Cone Seat)

Special GLP Dies Required.

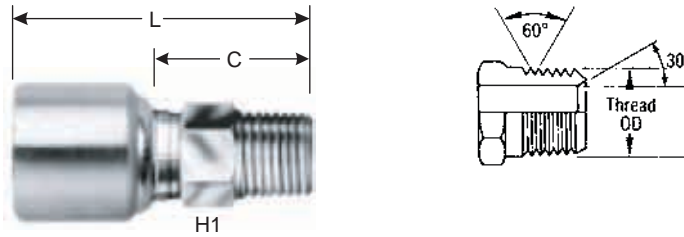

Descr.	Prod. No.	⊖		🌀	H1	H2	L		C		Std. Pack
		"	mm		"	"	"	mm	"	mm	
<b>STANDARD PACK</b>											
4GLP1-4MP	7351-02045	1/4	6.4	1/4	9/16	—	1.89	48.0	1.22	31.0	1
6GLP1-6MP	7351-02155	3/8	9.5	3/8	11/16	—	2.13	54.0	1.33	33.8	1
8GLP1-8MP	7351-02215	1/2	12.7	1/2	7/8	—	2.24	57.0	1.46	37.1	1
10GLP1-8MP	7351-02275	5/8	15.9	1/2	15/16	—	2.40	61.0	1.55	39.3	1
12GLP1-12MP	7351-02325	3/4	19.0	3/4	1 1/16	—	2.64	67.0	1.56	39.5	1
<b>BULK PACK</b>											
4GLP1-4MPXBULK	7351-0204	1/4	6.4	1/4	9/16	—	1.89	48.0	1.22	31.0	200
6GLP1-6MPXBULK	7351-0215	3/8	9.5	3/8	11/16	—	2.13	54.0	1.33	33.8	150
8GLP1-8MPXBULK	7351-0221	1/2	12.7	1/2	7/8	—	2.24	57.0	1.46	37.1	100
10GLP1-8MPXBULK	7351-0227	5/8	15.9	1/2	15/16	—	2.40	61.0	1.55	39.3	100
12GLP1-12MPXBULK	7351-0232	3/4	19.0	3/4	1 1/16	—	2.64	67.0	1.56	39.5	75

## Male JIC 37° Flare

Special GLP Dies Required.

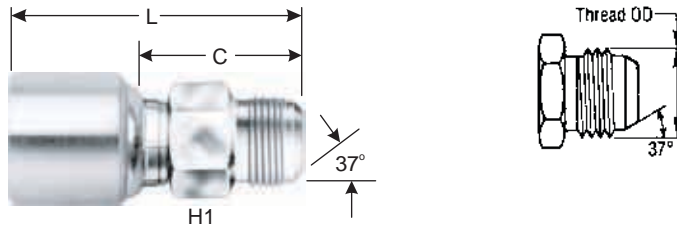

Descr.	Prod. No.	⊖		🌀	H1	H2	L		C		Std. Pack
		"	mm		mm	mm	"	mm	"	mm	
<b>STANDARD PACK</b>											
4GLP1-4MJ	7351-01045	1/4	6.4	7/16-20	9.0	—	1.81	46.0	1.18	30.0	1
6GLP1-6MJ	7351-01155	3/8	9.5	9/16-18	11.0	—	1.97	50.0	1.23	31.3	1
8GLP1-8MJ	7351-01215	1/2	12.7	3/4-16	7.0	—	2.13	54.0	1.34	34.1	1
10GLP1-10MJ	7351-01275	5/8	15.8	7/8-14	15.0	—	2.44	62.0	1.59	40.3	1
12GLP1-12MJ	7351-01325	3/4	19.0	1 1/16-12	1.0	—	2.83	72.0	1.75	44.5	1
<b>BULK PACK</b>											
4GLP1-4MJXBULK	7351-0104	1/4	6.4	7/16-20	9.0	—	1.81	46.0	1.18	30.0	400
6GLP1-6MJXBULK	7351-0115	3/8	9.5	9/16-18	11.0	—	1.97	50.0	1.23	31.3	500
8GLP1-8MJXBULK	7351-0121	1/2	12.7	3/4-16	7.0	—	2.13	54.0	1.34	34.1	100
10GLP1-10MJXBULK	7351-0127	5/8	15.8	7/8-14	15.0	—	2.44	62.0	1.59	40.3	100
12GLP1-12MJXBULK	7351-0132	3/4	19.0	1 1/16-12	1.0	—	2.83	72.0	1.75	44.5	75





## Female JIC 37° Flare Swivel

Special GLP Dies Required.

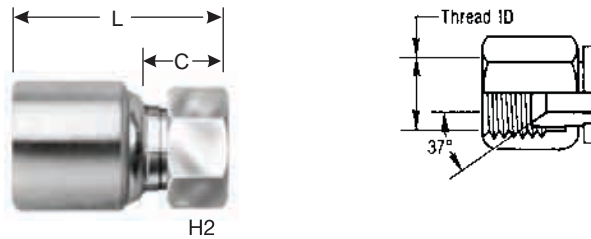

Descr.	Prod. No.	⊖		🌀	H1	H2	L		C		Std. Pack
		"	mm		mm	mm	"	mm	"	mm	
<b>STANDARD PACK</b>											
4GLP1-4FJX	7351-05045	1/4	6.4	7/16-20	—	9.0	1.63	41.3	.96	24.3	1
6GLP1-6FJX	7351-05145	3/8	9.5	9/16-18	—	11.0	1.89	48.1	1.10	27.9	1
8GLP1-8FJX	7351-05205	1/2	12.7	3/4-16	—	7.0	2.02	51.4	1.24	31.5	1
10GLP1-10FJX	7351-05265	5/8	15.8	7/8-14	—	15.0	2.27	57.7	1.42	36.0	1
12GLP1-12FJX	7351-05325	3/4	19.0	1 1/16-12	—	1.0	2.56	64.9	1.47	37.4	1
<b>BULK PACK</b>											
4GLP1-4FJX XBULK	7351-0504	1/4	6.4	7/16-20	—	9.0	1.63	41.3	.96	24.3	600
6GLP1-6FJX XBULK	7351-0514	3/8	9.5	9/16-18	—	11.0	1.89	48.1	1.10	27.9	300
8GLP1-8FJX XBULK	7351-0520	1/2	12.7	3/4-16	—	7.0	2.02	51.4	1.24	31.5	200
10GLP1-10FJX XBULK	7351-0526	5/8	15.8	7/8-14	—	15.0	2.27	57.7	1.42	36.0	100
12GLP1-12FJX XBULK	7351-0532	3/4	19.0	1 1/16-12	—	1.0	2.56	64.9	1.47	37.4	100

## Female JIC 37° Flare Swivel - 45° Short Bent Tube

Special GLP Dies Required.

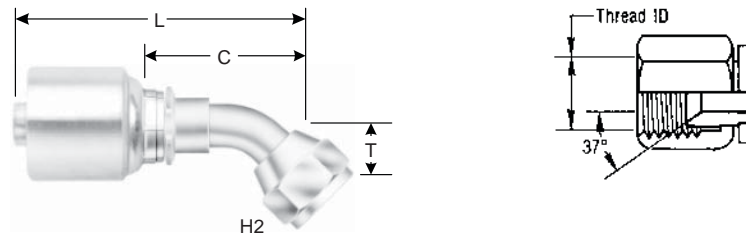

Descr.	Prod. No.	⊖		🌀	H1	H2	T		L		C		Std. Pack
		"	mm		mm	mm	"	mm	"	mm	"	mm	
<b>STANDARD PACK</b>													
4GLP1-4FJX45S	7351-11055	1/4	6.4	7/16-20	—	9.0	.39	10.0	2.37	60.2	1.74	44.2	1
6GLP1-6FJX45S	7351-11235	3/8	9.5	9/16-18	—	11.0	.43	11.0	2.96	75.1	2.22	56.4	1
8GLP1-8FJX45S	7351-09295	1/2	12.7	3/4-16	—	7.0	.59	15.0	2.96	75.1	2.17	55.2	1
10GLP1-10FJX45S	7351-09355	5/8	15.8	7/8-14	—	15.0	.63	16.0	3.21	81.5	2.35	59.8	1
12GLP1-12FJX45S	7351-09425	3/4	19.0	1 1/16-12	—	1.0	.83	21.0	3.94	100.0	2.85	72.5	1
<b>BULK PACK</b>													
4GLP1-4FJX45SXBULK	7351-1105	1/4	6.4	7/16-20	—	9.0	.39	10.0	2.37	60.2	1.74	44.2	200
6GLP1-6FJX45SXBULK	7351-1123	3/8	9.5	9/16-18	—	11.0	.43	11.0	2.96	75.1	2.22	56.4	150
8GLP1-8FJX45SXBULK	7351-0929	1/2	12.7	3/4-16	—	7.0	.59	15.0	2.96	75.1	2.17	55.2	100
10GLP1-10FJX45SXBULK	7351-0935	5/8	15.8	7/8-14	—	15.0	.63	16.0	3.21	81.5	2.35	59.8	100
12GLP1-12FJX45SXBULK	7351-0942	3/4	19.0	1 1/16-12	—	1.0	.83	21.0	3.94	100.0	2.85	72.5	75

EQUIPMENT

HOSE/CPLG. SELECTION

GLOBALSPIRAL COUPLINGS

PCM/PCS FERRULES

MEGACRIMP COUPLINGS

POWER CRIMP COUPLINGS

LOW PRESSURE COUPLINGS

POLARSEAL COUPLINGS

C14 COUPLINGS

PCTS THERMO-PLASTIC COUPLINGS

FIELD ATTACHABLE G1 & G2 COUPLINGS

FIELD ATTACHABLE C5 COUPLINGS

SURELOK AIR BRAKE COUPLINGS

QUICK DISCONNECT COUPLERS

NEW BALL VALVES

ACCESSORIES

EQUIPMENT AND PARTS





# GLP Couplings

## Female JIC 37° Flare Swivel - 90° Short Bent Tube

Special GLP Dies Required.

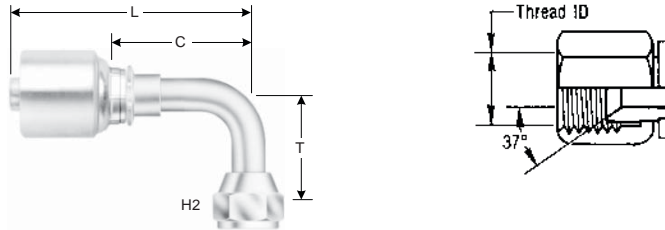

Descr.	Prod. No.	⊖		🌀	H1	H2	T		L		C		Std. Pack
		"	mm		mm	mm	"	mm	"	mm	"	mm	
<b>STANDARD PACK</b>													
4GLP1-4FJX90S	7351-15045	1/4	6.4	7/16-20	—	9.0	.83	21.0	2.11	53.6	1.48	37.6	1
6GLP1-6FJX90S	7351-15205	3/8	9.5	9/16-18	—	11.0	.91	23.0	2.67	67.8	1.93	49.1	1
8GLP1-8FJX90S	7351-15285	1/2	12.7	3/4-16	—	7.0	1.14	29.0	2.59	65.7	1.80	45.8	1
10GLP1-10FJX90S	7351-15365	5/8	15.8	7/8-14	—	15.0	1.26	32.0	2.93	74.4	2.07	52.7	1
12GLP1-12FJX90S	7351-15465	3/4	19.0	1 1/16-12	—	1.0	1.89	48.0	3.78	96.0	2.70	68.5	1
<b>BULK PACK</b>													
4GLP1-4FJX90SXBULK	7351-1504	1/4	6.4	7/16-20	—	9.0	.83	21.0	2.11	53.6	1.48	37.6	200
6GLP1-6FJX90SXBULK	7351-1520	3/8	9.5	9/16-18	—	11.0	.91	23.0	2.67	67.8	1.93	49.1	250
8GLP1-8FJX90SXBULK	7351-1528	1/2	12.7	3/4-16	—	7.0	1.14	29.0	2.59	65.7	1.80	45.8	100
10GLP1-10FJX90SXBULK	7351-1536	5/8	15.8	7/8-14	—	15.0	1.26	32.0	2.93	74.4	2.07	52.7	100
12GLP1-12FJX90SXBULK	7351-1546	3/4	19.0	1 1/16-12	—	1.0	1.89	48.0	3.78	96.0	2.70	68.5	75

## Female JIC 37° Flare Swivel - 90° Long Bent Tube

Special GLP Dies Required.

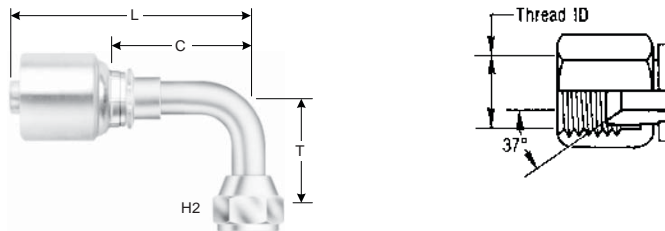

Descr.	Prod. No.	⊖		🌀	H1	H2	T		L		C		Std. Pack
		"	mm		mm	mm	"	mm	"	mm	"	mm	
<b>STANDARD PACK</b>													
4GLP1-4FJX90L	7351-15065	1/4	6.4	7/16-20	—	9.0	1.81	46.0	2.11	53.6	1.48	37.6	1
6GLP1-6FJX90L	7351-15225	3/8	9.5	9/16-18	—	11.0	2.13	54.0	2.67	67.8	1.93	49.1	1
8GLP1-8FJX90L	7351-15305	1/2	12.7	3/4-16	—	7.0	2.52	64.0	2.69	68.4	1.91	48.5	1
10GLP1-10FJX90L	7351-15385	5/8	15.8	7/8-14	—	15.0	2.76	70.0	2.62	66.5	1.76	44.8	1
12GLP1-12FJX90L	7351-15445	3/4	19.0	1 1/16-12	—	1.0	3.78	96.0	3.27	83.0	2.19	55.5	1
<b>BULK PACK</b>													
4GLP1-4FJX90LXBULK	7351-1506	1/4	6.4	7/16-20	—	9.0	1.81	46.0	2.11	53.6	1.48	37.6	200
6GLP1-6FJX90LXBULK	7351-1522	3/8	9.5	9/16-18	—	11.0	2.13	54.0	2.67	67.8	1.93	49.1	150
8GLP1-8FJX90LXBULK	7351-1530	1/2	12.7	3/4-16	—	7.0	2.52	64.0	2.69	68.4	1.91	48.5	100
10GLP1-10FJX90LXBULK	7351-1538	5/8	15.8	7/8-14	—	15.0	2.76	70.0	2.62	66.5	1.76	44.8	100
12GLP1-12FJX90LXBULK	7351-1544	3/4	19.0	1 1/16-12	—	1.0	3.78	96.0	3.27	83.0	2.19	55.5	50





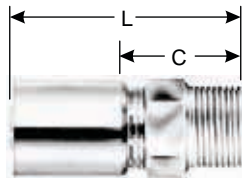

## Male Pipe (NPTF - 30° Cone Seat)

Special GL Dies Required.

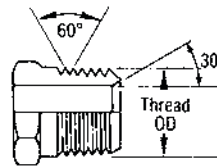

H1



Descr.	Prod. No.	⊖			H1	H2	L		C		Std. Pack
		"	mm		"	"	"	mm	"	mm	
<b>STANDARD PACK</b>											
12GL-12MP	7348-00015	3/4	19.0	3/4-14	1 3/4	—	3.46	88.0	1.46	37.0	1
12GL-16MP	7348-00025	3/4	19.0	1-11 1/2	1 3/8	—	1.77	92.5	1.64	41.6	1
16GL-16MP	7348-00035	1	25.4	1-11 1/2	1 3/8	—	4.11	104.5	1.88	47.7	1
20GL-20MP	7348-00045	1 1/4	31.8	1 1/4-11 1/2	1 3/4	—	2.13	112.0	2.09	53.0	1
24GL-24MP	7348-00055	1 1/2	38.1	1 1/2-11 1/2	2	—	4.83	122.7	2.19	55.7	1
32GL-32MP	7348-00065	2	50.8	2-11 1/2	2 1/2	—	5.39	137.0	2.33	59.2	1
<b>BULK PACK</b>											
12GL-12MPXBULK	7348-0001	3/4	19.0	3/4-14	1 3/4	—	3.46	88.0	1.46	37.0	50
16GL-16MPXBULK	7348-0003	1	25.4	1-11 1/2	1 3/8	—	4.11	104.5	1.88	47.7	40
20GL-20MPXBULK	7348-0004	1 1/4	31.8	1 1/4-11 1/2	1 3/4	—	2.13	112.0	2.09	53.0	20
24GL-24MPXBULK	7348-0005	1 1/2	38.1	1 1/2-11 1/2	2	—	4.83	122.7	2.19	55.7	25
32GL-32MPXBULK	7348-0006	2	50.8	2-11 1/2	2 1/2	—	5.39	137.0	2.33	59.2	12

## Male Pipe Swivel (NPTF - Without 30° Cone Seat)

NOT TO BE USED AS A LIVE SWIVEL.

Special GL Dies Required.



H2

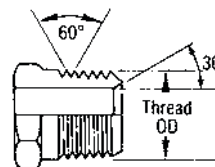

Descr.	Prod. No.	⊖			H1	H2	L		C		Std. Pack
		"	mm		"	"	"	mm	"	mm	
<b>STANDARD PACK</b>											
12GL-12MPX	7348-00105	3/4	19.0	3/4-14	—	1 5/16	4.02	102.0	2.01	51.0	1
16GL-16MPX	7348-00115	1	25.4	1-11 1/2	—	1 5/8	4.73	120.2	2.50	63.4	1
<b>BULK PACK</b>											
12GL-12MPX XBULK	7348-0010	3/4	19.0	3/4-14	—	1 5/16	4.02	102.0	2.01	51.0	50
16GL-16MPX XBULK	7348-0011	1	25.4	1-11 1/2	—	1 5/8	4.73	120.2	2.50	63.4	25

EQUIPMENT

HOSE/CPLG. SELECTION

GLOBALSPIRAL COUPLINGS

PCM/PCS FERRULES

MEGACRIMP COUPLINGS

POWER CRIMP COUPLINGS

LOW PRESSURE COUPLINGS

POLARSEAL COUPLINGS

C14 COUPLINGS

PCTS THERMO-PLASTIC COUPLINGS

FIELD ATTACHABLE G1 & G2 COUPLINGS

FIELD ATTACHABLE C5 COUPLINGS

SURELOK AIR BRAKE COUPLINGS

QUICK DISCONNECT COUPLERS

NEW BALL VALVES

ACCESSORIES

EQUIPMENT AND PARTS



# GL Couplings



EQUIPMENT

HOSE/CPLG. SELECTION

GLOBALSPIRAL COUPLINGS

PCM/PCS FERRULES

MEGACRIMP COUPLINGS

POWER CRIMP COUPLINGS

LOW PRESSURE COUPLINGS

POLARSEAL COUPLINGS

C14 COUPLINGS

PCTS THERMO-PLASTIC COUPLINGS

FIELD ATTACHABLE G1 & G2 COUPLINGS

FIELD ATTACHABLE C5 COUPLINGS

SURELOK AIR BRAKE COUPLINGS

QUICK DISCONNECT COUPLERS

NEW BALL VALVES

ACCESSORIES

EQUIPMENT AND PARTS

## Female JIC 37° Flare Swivel

Special GL Dies Required.

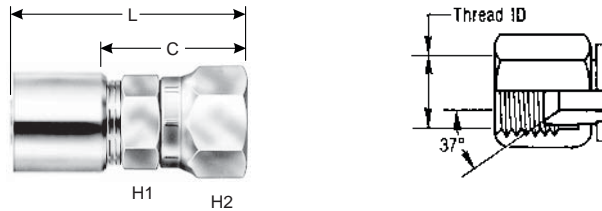

Descr.	Prod. No.	⊖		🌀	H1	H2	L		C		Std. Pack
		"	mm		"	"	"	mm	"	mm	
<b>STANDARD PACK</b>											
12GL-12FJX	7348-00205	3/4	19.0	1 1/16-12	1 1/16	1 1/4	3.68	93.5	1.67	42.5	1
12GL-14FJX	7348-00215	3/4	19.0	1 3/16-12	1 1/8	1 3/8	3.65	92.7	1.64	41.6	1
12GL-16FJX	7348-00225	3/4	19.0	1 5/16-12	1 1/4	1 1/2	3.78	96.0	1.77	45.0	1
16GL-16FJX	7348-00235	1	25.4	1 5/16-12	1 3/8	1 1/2	4.17	106.0	1.94	49.2	1
20GL-20FJX	7348-00245	1 1/4	31.8	1 5/8-12	1 3/4	2	4.58	116.4	2.26	57.4	1
24GL-20FJX	7348-00195	1 1/2	38.1	1 5/8-12	1 3/4	2	4.84	122.9	2.20	55.9	1
24GL-24FJX	7348-00255	1 1/2	38.1	1 7/8-12	2	2 1/4	5.19	131.7	2.55	64.7	1
32GL-32FJX	7348-00265	2 1/2	63.5	3-12	2 1/2	3 1/2	5.98	152.0	2.92	73.9	1
40GL-40FJX	7305-05475	2 1/2	63.5	2 1/2	3	3 1/2	5.36	136.4	2.91	73.9	1
<b>BULK PACK</b>											
12GL-12FJX XBULK	7348-0020	3/4	19.0	1 1/16-12	1 1/16	1 1/4	3.68	93.5	1.67	42.5	50
16GL-16FJX XBULK	7348-0023	1	25.4	1 5/16-12	1 3/8	1 1/2	4.17	106.0	1.94	49.2	25
20GL-20FJX XBULK	7348-0024	1 1/4	31.8	1 5/8-12	1 3/4	2	4.58	116.4	2.26	57.4	25
24GL-24FJX XBULK	7348-0025	1 1/2	38.1	1 7/8-12	2	2 1/4	5.19	131.7	2.55	64.7	15
32GL-32FJX XBULK	7348-0026	2	63.5	2 1/2-12	2 1/2	3 1/2	5.98	152.0	2.92	73.9	12

## Female JIC 37° Flare Swivel - 45° Short Bent Tube

Special GL Dies Required.

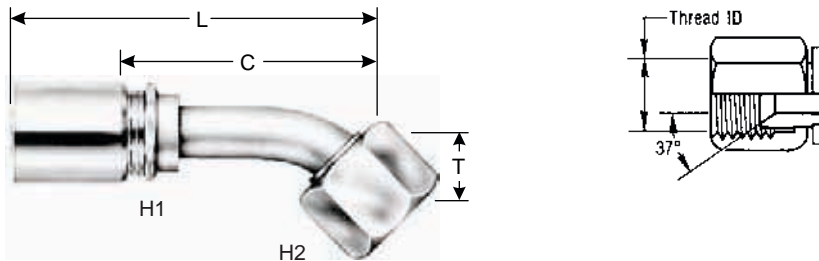

Descr.	Prod. No.	⊖		🌀	H1	H2	T		L		C		Std. Pack
		"	mm		"	"	"	mm	"	mm	"	mm	
<b>STANDARD PACK</b>													
12GL-12FJX45S-021	7348-01265	3/4	19.0	1 1/16-12	1 1/16	1 1/4	.83	21.0	4.76	121.0	2.76	70.0	1



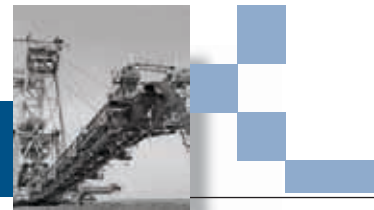

## Female JIC 37° Flare Swivel - 90° Short Bent Tube

Special GL Dies Required.

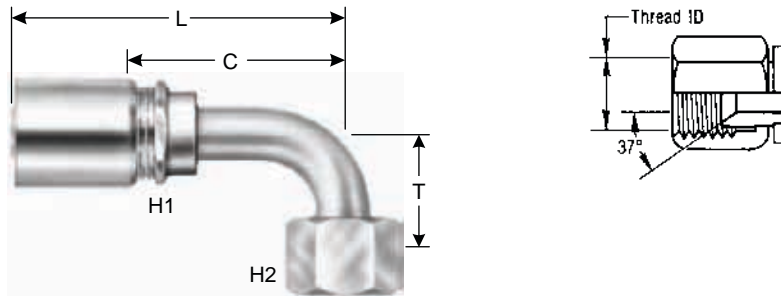

Descr.	Prod. No.	⊖		🌀	H1	H2	T		L		C		Std. Pack
		"	mm		"	"	"	mm	"	mm	"	mm	
<b>STANDARD PACK</b>													
12GL-12FJX90S	7348-01385	3/4	19.0	1 1/16-12	1 1/16	1 1/4	1.89	48.0	4.61	117.0	2.60	66.0	1
16GL-16FJX90S	7348-01485	1	25.4	1 5/16-12	1 3/8	1 1/2	2.20	56.0	5.12	130.0	2.88	73.2	1
<b>BULK PACK</b>													
12GL-12FJX90SXBULK	7348-0138	3/4	19.0	1 1/16-12	1 1/16	1 1/4	1.89	48.0	4.61	117.0	2.60	66.0	50
16GL-16FJX90SXBULK	7348-0148	1	25.4	1 5/16-12	1 3/8	1 1/2	2.20	56.0	5.12	130.0	2.88	73.2	30

## Female JIC 37° Flare Swivel - 90° Medium Bent Tube

Special GL Dies Required.

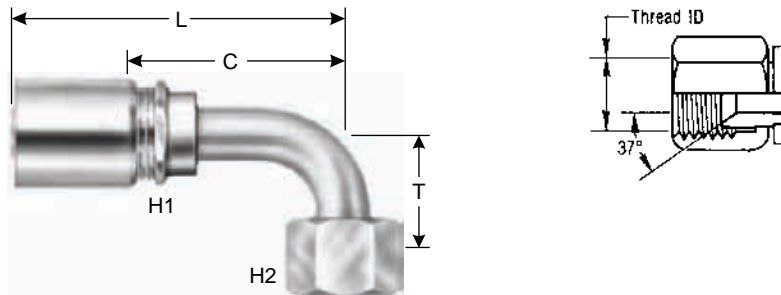

Descr.	Prod. No.	⊖		🌀	H1	H2	T		L		C		Std. Pack
		"	mm		"	"	"	mm	"	mm	"	mm	
<b>STANDARD PACK</b>													
20GL-20FJX90M	7348-01525	1 1/4	31.8	1 5/8-12	1 3/4	2	3.07	78.0	6.24	158.4	3.91	99.4	1
24GL-20FJX90M	7348-01585	1 1/2	38.1	1 5/8-12	1 3/4	2	3.07	78.0	6.24	158.4	3.91	99.4	1
24GL-24FJX90-092	7348-01545	1 1/2	38.1	1 7/8-12	2	2 1/4	4.05	98.0	7.10	173.2	4.85	110.7	1

EQUIPMENT

HOSE/CPLG. SELECTION

GLOBALSPIRAL COUPLINGS

PCM/PCS FERRULES

MEGACRIMP COUPLINGS

POWER CRIMP COUPLINGS

LOW PRESSURE COUPLINGS

POLARSEAL COUPLINGS

C14 COUPLINGS

PCTS THERMO-PLASTIC COUPLINGS

FIELD ATTACHABLE G1 & G2 COUPLINGS

FIELD ATTACHABLE C5 COUPLINGS

SURELOK AIR BRAKE COUPLINGS

QUICK DISCONNECT COUPLERS

NEW BALL VALVES

ACCESSORIES

EQUIPMENT AND PARTS





# GL Couplings

## Female JIC 37° Flare Swivel - 90° Long Bent Tube

Special GL Dies Required.

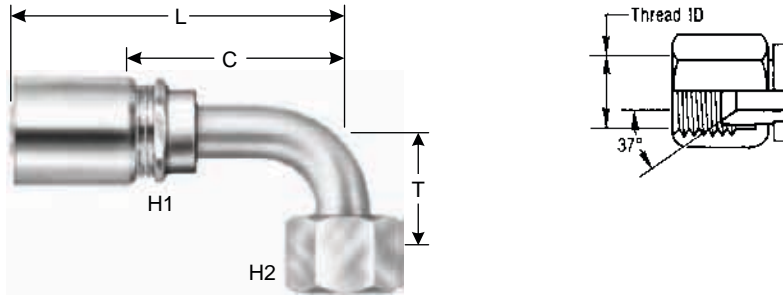

Descr.	Prod. No.	Ø		Spring	H1	H2	T		L		C		Std. Pack
		"	mm		"	"	"	mm	"	mm	"	mm	
<b>STANDARD PACK</b>													
24GL-20FJX90L	7348-01595	1 1/2	38.1	1 5/8-12	1 3/4	2	5.08	129.0	5.59	142.0	2.96	75.1	1

## Female Flat-Face Swivel

SAE J1453 O-Ring Face Seal.  
Special GL Dies Required.

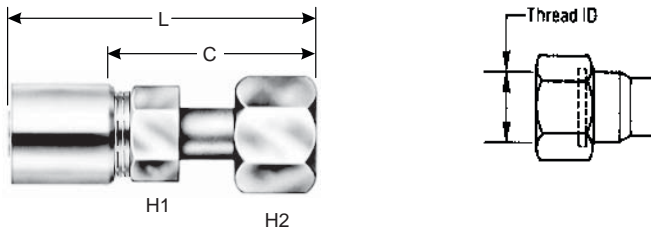

Descr.	Prod. No.	Ø		Spring	H1	H2	L		C		Std. Pack
		"	mm		"	"	"	mm	"	mm	
<b>STANDARD PACK</b>											
12GL-12FFORX	7348-00305	3/4	19.0	1 3/16-12	1 1/16	1 3/8	3.78	96.0	1.77	45.0	1
16GL-16FFORX	7348-00355	1	25.4	1 7/16-12	1 3/8	1 5/8	4.46	113.4	2.22	56.5	1
20GL-20FFORX	7348-00365	1 1/4	31.8	1 11/16-12	1 3/4	1 7/8	4.50	114.4	2.18	55.4	1

- EQUIPMENT
- HOSE/CPLG. SELECTION
- GLOBALSPIRAL COUPLINGS
- PCM/PCS FERRULES
- MEGACRIMP COUPLINGS
- POWER CRIMP COUPLINGS
- LOW PRESSURE COUPLINGS
- POLARSEAL COUPLINGS
- C14 COUPLINGS
- PCTS THERMO-PLASTIC COUPLINGS
- FIELD ATTACHABLE G1 & G2 COUPLINGS
- FIELD ATTACHABLE C5 COUPLINGS
- SURELOK AIR BRAKE COUPLINGS
- QUICK DISCONNECT COUPLERS
- NEW BALL VALVES
- ACCESSORIES
- EQUIPMENT AND PARTS





## Female Flat-Face Swivel - 45° Short Bent Tube

SAE J1453 O-Ring Face Seal.  
Special GL Dies Required.

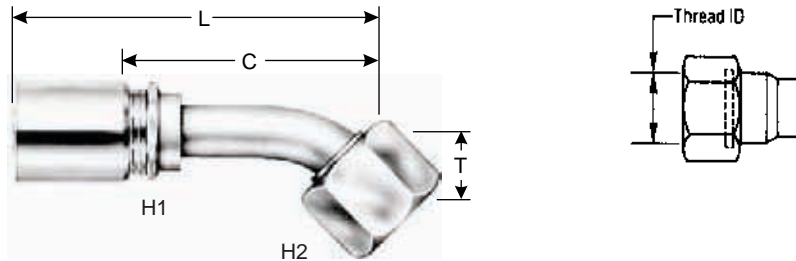

Descr.	Prod. No.	⊖			H1	H2	T		L		C		Std. Pack
		"	mm		"	"	"	mm	"	mm	"	mm	
<b>STANDARD PACK</b>													
12GL-12FFORX45S	7348-00405	3/4	19.1	1 7/16-12	1 1/16	1 3/8	.83	21.0	4.67	118.5	2.66	67.5	1
16GL-16FFORX45S	7348-00415	1	25.4	1 7/16-12	1 3/8	1 5/8	.94	24.0	5.08	129.1	2.85	72.3	1
20GL-20FFORX45S	7348-00425	1 1/2	31.8	1 11/16-12	1 3/4	1 7/8	.98	25.0	5.81	147.6	3.49	88.6	1

## Female Flat-Face Swivel - 90° Short Bent Tube

SAE J1453 O-Ring Face Seal.  
Special GL Dies Required.

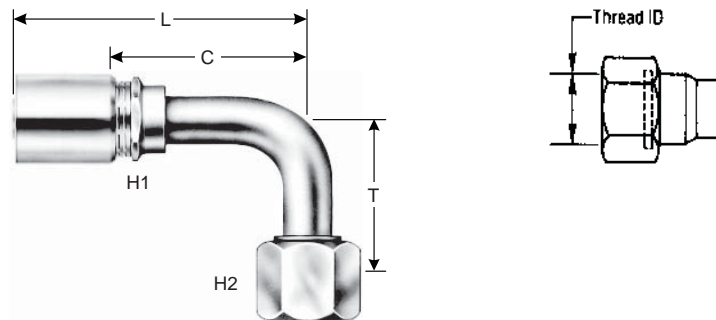

Descr.	Prod. No.	⊖			H1	H2	T		L		C		Std. Pack
		"	mm		"	"	"	mm	"	mm	"	mm	
<b>STANDARD PACK</b>													
12GL-12FFORX90S	7348-00455	3/4	19.1	1 3/16-12	1 1/16	1 3/8	1.89	48.0	4.28	108.8	2.28	57.8	1
16GL-16FFORX90S	7348-00465	1	25.4	1 7/16-12	1 3/8	1 5/8	2.20	56.0	5.11	129.9	2.88	73.1	1
20GL-20FFORX90S	7348-00475	1 1/4	31.8	1 11/16-12	1 3/4	1 7/8	2.52	64.0	5.51	140.0	3.19	81.0	1

EQUIPMENT
HOSE/CPLG. SELECTION
GLOBALSPIRAL COUPLINGS
PCM/PCS FERRULES
MEGACRIMP COUPLINGS
POWER CRIMP COUPLINGS
LOW PRESSURE COUPLINGS
POLARSEAL COUPLINGS
C14 COUPLINGS
PCTS THERMO-PLASTIC COUPLINGS
FIELD ATTACHABLE G1 & G2 COUPLINGS
FIELD ATTACHABLE C5 COUPLINGS
SURELOK AIR BRAKE COUPLINGS
QUICK DISCONNECT COUPLERS
NEW BALL VALVES
ACCESSORIES
EQUIPMENT AND PARTS





# GL Couplings

## Female Flat-Face Swivel - 90° Medium Bent Tube

SAE J1453 O-Ring Face Seal.  
Special GL Dies Required.

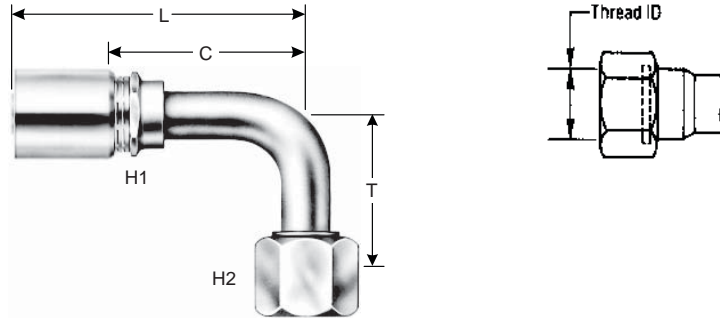

Descr.	Prod. No.	⊖		🌀	H1	H2	T		L		C		Std. Pack
		"	mm		"	"	"	mm	"	mm	"	mm	
<b>STANDARD PACK</b>													
12GL-12FFORX90M	7348-02155	3/4	19.1	1 3/16-12	1 1/16	1 1/4	1.89	48.0	4.61	117.0	2.60	66.0	1

## Code 61 O-Ring Flange

Special GL Dies Required.

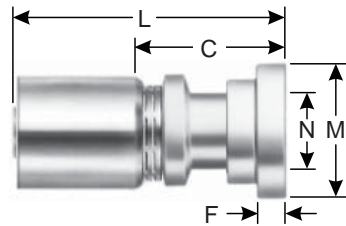

Descr.	Prod. No.	⊖		N	M	L		C		F		Std. Pack	
		"	mm	"	"	mm	"	mm	"	mm	"		mm
<b>STANDARD PACK</b>													
12GL-12FL	7348-00505	3/4	19.0	3/4	1.50	38.1	3.86	98.0	1.85	47.0	.27	6.7	1
16GL-16FL	7348-00555	1	25.4	1	1.75	44.5	3.78	96.0	1.54	39.2	.32	8.0	1
20GL-20FL	7348-00525	1 1/4	31.8	1 1/4	2.00	50.8	4.43	112.5	2.11	53.5	.32	8.0	1
24GL-24FL	7348-00535	1 1/2	38.1	1 1/2	2.38	60.5	4.94	125.4	2.30	58.4	.32	8.0	1
32GL-32FL	7348-00545	2	50.8	2	2.81	71.4	5.61	142.5	2.54	64.5	.38	9.5	1
40GL-40FL	7305-05505	2 1/2	63.5	2 1/2	3.31	84.1	5.66	143.8	3.15	80.0	.38	9.5	1
40GL-48FL	7305-05605	2 1/2	63.5	3	4.00	101.6	5.66	143.8	3.21	81.5	.38	9.5	1
40GL-56FL	7305-05705	2 1/2	63.5	3 1/2	4.50	114.3	5.33	135.4	2.77	70.3	.44	11.2	1
40GL-64FL	7305-05795	2 1/2	63.5	4	5.00	127.0	5.33	135.4	2.88	73.2	.44	11.2	1
48GL-48FL	7305-05805	3	76.2	3	4.00	101.6	6.54	166.1	3.46	87.9	.32	8.0	1
56GL-56FL	7305-06305	3 1/2	88.9	3 1/2	4.50	114.3	6.70	170.2	3.06	77.7	.32	8.0	1
64GL-64FL	7305-06695	4	101.6	4	5.00	127.0	7.74	196.6	3.70	94.0	.44	11.2	1
<b>BULK PACK</b>													
20GL-20FLXBULK	7348-0052	1 1/4	31.8	1 1/4	2.00	50.8	4.43	112.5	2.11	53.5	.32	8.0	25
32GL-32FLXBULK	7348-0054	2	50.8	2	2.81	71.4	5.61	142.5	2.54	64.5	.38	9.5	12





## Code 61 O-Ring Flange - 22° Bent Tube

Special GL Dies Required.

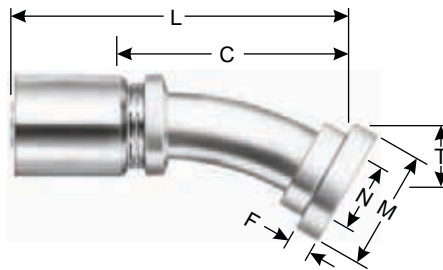

Descr.	Prod. No.	⊖		N		M		T		L		C		F		Std. Pack
		"	mm	"	"	mm	"	mm	"	mm	"	mm	"	mm		
<b>STANDARD PACK</b>																
24GL-24FL22M-018	7348-00575	1/12	38.1	1/12	2.38	60.5	.71	18.0	6.39	162.3	3.76	95.4	.32	8.1	1	
40GL-40FL22	7305-05515	2 1/2	63.5	2 1/2	3.31	84.1	.63	16.0	6.81	173.0	4.36	110.7	.38	9.5	1	
40GL-48FL22	7305-05615	2 1/2	63.5	3	4.00	101.6	.67	17.0	6.86	174.2	4.41	112.0	.38	9.5	1	

## Code 61 O-Ring Flange - 30° Medium Bent Tube

Special GL Dies Required.

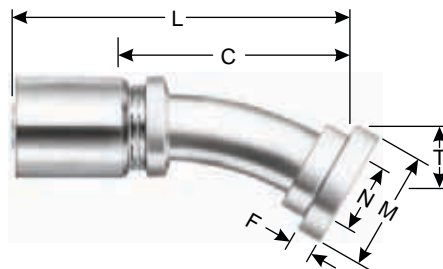

Descr.	Prod. No.	⊖		N		M		T		L		C		F		Std. Pack
		"	mm	"	"	mm	"	mm	"	mm	"	mm	"	mm		
<b>STANDARD PACK</b>																
12GL-12FL30M	7348-00605	3/4	19.1	3/4	1.50	38.1	.63	16.0	4.51	114.6	2.50	63.5	.27	6.9	1	
16GL-16FL30M	7348-00615	1	25.4	1	1.75	44.5	.75	19.0	4.92	125.0	2.69	68.3	.32	8.1	1	
20GL-20FL30M	7348-00625	1 1/4	31.8	1 1/4	2.00	50.8	.87	22.0	5.37	136.4	3.05	77.5	.32	8.1	1	
24GL-24FL30M	7348-00635	1 1/2	38.1	1 1/2	2.38	60.5	1.18	30.0	6.86	174.2	4.22	107.3	.32	8.1	1	
32GL-32FL30M	7348-00645	2	50.8	2	2.81	71.4	1.26	32.0	7.78	197.6	4.72	119.8	.38	9.5	1	
40GL-40FL30	7305-05525	2 1/2	63.5	2 1/2	3.31	84.1	1.08	27.4	7.30	185.4	4.85	123.2	.38	9.5	1	
40GL-48FL30	7305-05625	2 1/2	63.5	3	4.00	101.6	1.08	27.4	7.36	186.9	4.91	124.7	.38	9.5	1	
48GL-48FL30	7305-05825	3	76.2	3	4.00	101.6	1.12	28.4	8.23	209.0	5.15	130.8	.38	9.5	1	
<b>BULK PACK</b>																
32GL-32FL30MXBULK	7348-0064	2	50.8	2	2.81	71.4	1.26	32.0	7.78	197.6	4.72	119.8	.38	9.5	9	

EQUIPMENT

HOSE/CPLG. SELECTION

GLOBALSPIRAL COUPLINGS

PCM/PCS FERRULES

MEGACRIMP COUPLINGS

POWER CRIMP COUPLINGS

LOW PRESSURE COUPLINGS

POLARSEAL COUPLINGS

C14 COUPLINGS

PCTS THERMO-PLASTIC COUPLINGS

FIELD ATTACHABLE G1 & G2 COUPLINGS

FIELD ATTACHABLE C5 COUPLINGS

SURELOK AIR BRAKE COUPLINGS

QUICK DISCONNECT COUPLERS

NEW BALL VALVES

ACCESSORIES

EQUIPMENT AND PARTS



# GL Couplings



## Code 61 O-Ring Flange - 45° Short Bent Tube

Special GL Dies Required.

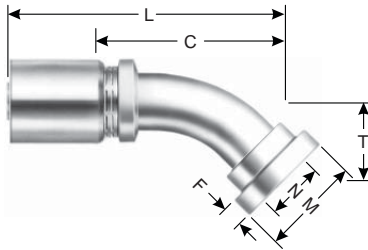

Descr.	Prod. No.	⊖		N	M		T		L		C		F		Std. Pack
		"	mm		"	"	mm	"	mm	"	mm	"	mm	"	
<b>STANDARD PACK</b>															
16GL-16FL45S	7348-00715	1	25.4	1	1.75	44.5	1.10	28.0	5.11	129.8	2.87	72.9	.32	8.1	1
20GL-20FL45S	7348-00725	1 1/4	31.8	1 1/4	2.00	50.8	1.26	32.0	5.59	142.0	3.29	83.6	.32	8.1	1
24GL-24FL45S	7348-00735	1 1/2	38.1	1 1/2	2.38	60.5	1.50	38.0	6.62	168.2	3.99	101.3	.32	8.1	1
32GL-32FL45S	7348-00745	2	50.8	2	2.81	71.4	2.05	52.0	8.07	204.9	5.00	127.1	.38	9.5	1
40GL-40FL45	7305-05535	2 1/2	63.5	2 1/2	3.31	84.1	1.72	43.7	7.72	196.1	5.27	133.8	.38	9.5	1
40GL-48FL45	7305-05635	2 1/2	63.5	3	4.00	101.6	1.76	44.7	7.76	197.1	5.31	134.9	.38	9.5	1
48GL-48FL45	7305-05835	3	76.2	3	4.00	101.6	2.03	51.6	9.18	233.2	6.10	154.9	.38	9.5	1
48GL-56FL45	7305-05895	3	76.2	3 1/2	4.50	114.3	2.03	51.6	12.38	314.4	9.30	236.2	—	11.2	1
56GL-56FL45	7305-06335	3 1/2	88.9	3 1/2	4.50	114.3	2.13	54.1	9.66	245.4	6.02	152.9	.44	11.2	1
56GL-64FL45	7305-06385	3 1/2	88.9	4	5.00	127.0	2.13	54.1	9.66	245.4	6.02	152.9	.44	11.2	1
64GL-64FL45	7305-06725	4	101.6	4	5.00	127.0	3.61	91.7	12.70	322.3	8.66	153.0	.44	11.2	1
<b>BULK PACK</b>															
32GL-32FL45SXBULK	7348-0074	2	38.1	2	2.81	71.4	2.05	52.0	8.07	204.9	5.00	127.1	.38	9.5	5

## Code 61 O-Ring Flange - 45° Medium Bent Tube

Special GL Dies Required.

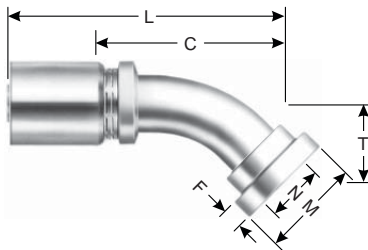

Descr.	Prod. No.	⊖		N	M		T		L		C		F		Std. Pack
		"	mm		"	"	mm	"	mm	"	mm	"	mm		
<b>STANDARD PACK</b>															
12GL-12FL45M	7348-00705	3/4	19.1	3/4	1.50	38.1	1.02	26.0	4.67	118.6	2.66	67.6	.27	8.0	1

EQUIPMENT

HOSE/CPLG. SELECTION

GLOBALSPIRAL COUPLINGS

PCM/PCS FERRULES

MEGACRIMP COUPLINGS

POWER CRIMP COUPLINGS

LOW PRESSURE COUPLINGS

POLARSEAL COUPLINGS

C14 COUPLINGS

PCTS THERMO-PLASTIC COUPLINGS

FIELD ATTACHABLE G1 & G2 COUPLINGS

FIELD ATTACHABLE C5 COUPLINGS

SURELOK AIR BRAKE COUPLINGS

QUICK DISCONNECT COUPLERS

NEW BALL VALVES

ACCESSORIES

EQUIPMENT AND PARTS





## Code 61 O-Ring Flange - 60° Short Bent Tube

Special GL Dies Required.

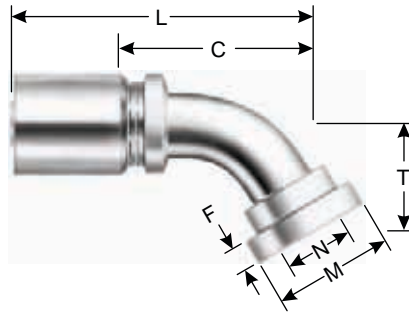

Descr.	Prod. No.	⊖		N		M		T		L		C		F		Std. Pack
		"	mm	"	"	mm	"	mm	"	mm	"	mm	"	mm		
<b>STANDARD PACK</b>																
20GL-20FL60S	7348-00825	1 1/4	31.8	1 1/4	2.00	50.8	1.77	45.0	5.67	144.0	3.35	85.1	.32	8.1	1	
24GL-24FL60S	7348-00835	1 1/2	38.1	1 1/2	2.38	60.5	2.09	53.0	6.63	168.4	3.99	101.4	.32	8.1	1	
32GL-32FL60S	7348-00845	2	50.8	2	2.81	71.4	2.95	75.0	8.59	218.1	5.52	140.3	.38	9.5	1	
40GL-40FL60	7305-05545	2 1/2	63.5	2 1/2	3.31	84.1	2.63	66.8	8.13	206.5	5.68	144.3	.38	9.5	1	
48GL-48FL60	7305-05845	3	76.2	3	4.00	101.6	3.11	79.0	9.66	245.4	6.58	167.1	.38	9.5	1	

## Code 61 O-Ring Flange - 60° Medium Bent Tube

Special GL Dies Required.

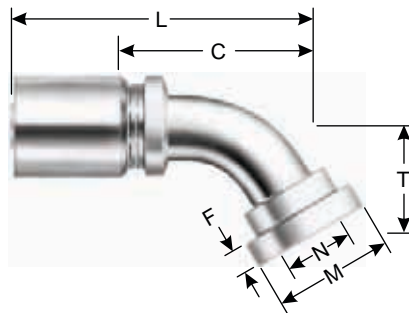

Descr.	Prod. No.	⊖		N		M		T		L		C		F		Std. Pack
		"	mm	"	"	mm	"	mm	"	mm	"	mm	"	mm		
<b>STANDARD PACK</b>																
12GL-12FL60M	7348-00805	3/4	19.1	3/4	1.50	38.1	1.46	37.0	4.61	117.1	2.60	66.0	.27	8.0	1	
16GL-16FL60M	7348-00815	1	25.4	1	1.75	44.5	1.73	44.0	5.14	130.6	2.90	73.7	.32	8.1	1	

EQUIPMENT

HOSE/CPLG. SELECTION

GLOBALSPIRAL COUPLINGS

PCM/PCS FERRULES

MEGACRIMP COUPLINGS

POWER CRIMP COUPLINGS

LOW PRESSURE COUPLINGS

POLARSEAL COUPLINGS

C14 COUPLINGS

PCTS THERMO-PLASTIC COUPLINGS

FIELD ATTACHABLE G1 & G2 COUPLINGS

FIELD ATTACHABLE C5 COUPLINGS

SURELOK AIR BRAKE COUPLINGS

QUICK DISCONNECT COUPLERS

NEW BALL VALVES

ACCESSORIES

EQUIPMENT AND PARTS





# GL Couplings

## Code 61 O-Ring Flange - 67½° Short Bent Tube

Special GL Dies Required.

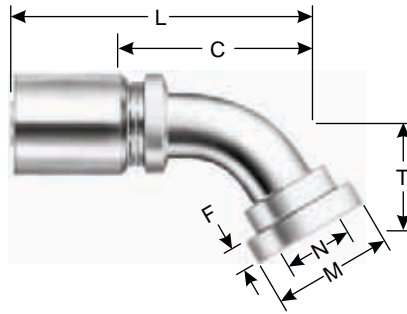

Descr.	Prod. No.	⊖		N	M		T		L		C		F		Std. Pack
		"	mm		"	"	mm	"	mm	"	mm	"	mm	"	
<b>STANDARD PACK</b>															
32GL-32FL67S	7348-00875	2	50.8	2	2.81	71.4	3.35	85.0	8.56	217.3	5.49	139.5	.38	9.5	1
40GL-40FL67	7305-05555	2 1/2	63.5	2 1/2	3.31	84.1	3.13	79.5	8.22	208.8	5.77	146.6	.38	9.5	1
48GL-48FL67	7305-05905	3	76.2	3	4.00	101.6	3.87	98.3	9.50	241.3	6.42	163.1	.38	9.5	1
64GL-64FL67	7305-06635	4	101.6	4	5.00	127.0	6.90	175.3	14.20	360.7	10.17	258.3	.44	11.2	1

## Code 61 O-Ring Flange - 90° Short Bent Tube

Special GL Dies Required.

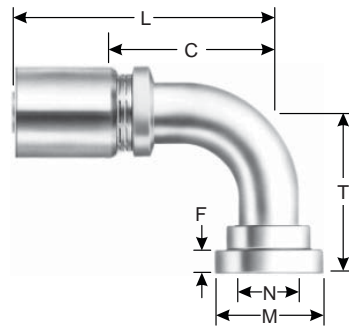

Descr.	Prod. No.	⊖		N	M		T		L		C		F		Std. Pack
		"	mm		"	"	mm	"	mm	"	mm	"	mm	"	
<b>STANDARD PACK</b>															
12GL-16FL90S	7348-00915	3/4	19.0	1	1.75	44.5	2.40	61.0	4.40	111.7	2.39	60.7	.32	8.1	1
16GL-16FL90S	7348-00925	1	25.4	1	1.75	44.5	2.40	61.0	5.04	128.1	2.81	71.3	.32	8.1	1
16GL-20FL90S	7348-00935	1	25.4	1 1/4	2.00	50.8	2.68	68.0	5.04	128.1	2.81	71.3	.32	8.1	1
20GL-20FL90S	7348-00945	1 1/4	31.8	1 1/4	2.00	50.8	2.68	68.0	5.41	137.5	3.09	78.5	.32	8.1	1
20GL-24FL90-068	7348-00955	1 1/4	31.8	1 1/2	2.38	60.5	2.68	68.0	5.41	137.5	3.09	78.5	.32	8.1	1
24GL-24FL90S	7348-00965	1 1/2	38.1	1 1/2	2.38	60.5	3.12	79.2	6.26	159.0	3.62	91.9	.32	8.1	1
32GL-32FL90S	7348-00975	2	50.8	2	2.81	71.4	4.50	114.3	8.73	221.7	5.20	132.1	.38	9.5	1
40GL-40FL90	7305-05565	2 1/2	63.5	2 1/2	3.31	84.1	4.62	117.3	8.06	204.7	5.61	142.5	.38	9.5	1
40GL-48FL90	7305-05665	2 1/2	63.5	3	4.00	101.6	4.62	117.3	8.12	206.2	5.67	144.0	.38	9.5	1
40GL-56FL90	7305-05765	2 1/2	63.5	3 1/2	4.50	114.3	4.62	117.3	8.25	209.6	5.80	147.3	.38	11.2	1
48GL-48FL90	7305-05855	3	76.2	3	4.00	101.6	5.50	139.7	9.70	246.4	6.62	168.1	.38	9.5	1
56GL-56FL90	7305-06365	3 1/2	88.9	3 1/2	4.50	114.3	5.63	143.0	10.17	258.3	6.53	165.9	.38	11.2	1
56GL-64FL90	7305-06395	3 1/2	88.9	4	5.00	127.0	6.90	175.3	10.09	256.3	6.45	163.8	.38	11.2	1
64GL-64FL90	7305-06645	4	101.6	4	5.00	127.0	7.38	187.4	12.61	320.3	8.58	217.9	.38	11.2	1





## Code 61 O-Ring Flange - 90° Short Bent Tube - Cont'd

Descr.	Prod. No.	⊖		N	M		T		L		C		F		Std. Pack
		"	mm		"	"	mm	"	mm	"	mm	"	mm	"	
<b>BULK PACK</b>															
16GL-16FL90SXBULK	7348-0092	1	25.4	1	1.75	44.5	2.40	61.0	5.04	128.1	2.81	71.3	.32	8.1	25
20GL-20FL90SXBULK	7348-0094	1 1/4	31.8	1 1/4	2.00	50.8	2.68	68.0	5.41	137.5	3.09	78.5	.32	8.1	15
32GL-32FL90SXBULK	7348-0097	2	50.8	2	2.81	71.4	4.50	114.3	8.73	221.7	5.20	132.1	.38	9.5	5

## Code 61 O-Ring Flange - 90° Medium Bent Tube

Special GL Dies Required.

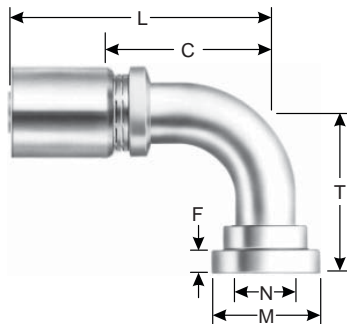

Descr.	Prod. No.	⊖		N	M		T		L		C		F		Std. Pack
		"	mm		"	"	mm	"	mm	"	mm	"	mm	"	
<b>STANDARD PACK</b>															
12GL-12FL90M	7348-00905	3/4	19.0	3/4	1.50	38.1	2.28	58.0	4.40	111.7	2.39	60.7	.27	6.9	1

EQUIPMENT

HOSE/CPLG. SELECTION

GLOBALSPIRAL COUPLINGS

PCM/PCS FERRULES

MEGACRIMP COUPLINGS

POWER CRIMP COUPLINGS

LOW PRESSURE COUPLINGS

POLARSEAL COUPLINGS

C14 COUPLINGS

PCTS THERMO-PLASTIC COUPLINGS

FIELD ATTACHABLE G1 & G2 COUPLINGS

FIELD ATTACHABLE C5 COUPLINGS

SURELOK AIR BRAKE COUPLINGS

QUICK DISCONNECT COUPLERS

NEW BALL VALVES

ACCESSORIES

EQUIPMENT AND PARTS

