

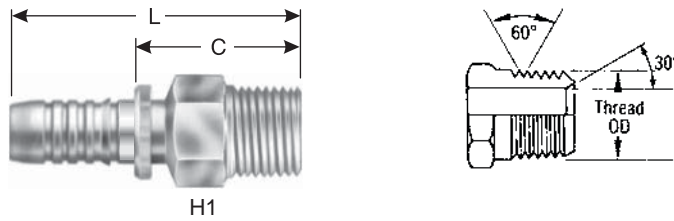



## Male Pipe (NPTF - 30° Cone Seat)

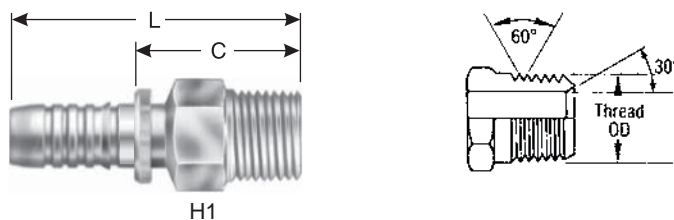

Descr.	Prod. No.	⊖			H1	H2	L		C		Std. Pack
		"	mm		"	"	"	mm	"	mm	
<b>STANDARD PACK</b>											
6GS-6MP	7347-20145	3/8	9.5	3/8-18	11/16	—	2.72	69.0	1.31	33.2	1
6GS-8MP	7347-20155	3/8	9.5	1/2-14	7/8	—	2.87	73.0	1.46	37.2	1
8GS-8MP	7347-20245	1/2	12.7	1/2-14	7/8	—	2.91	73.9	1.43	36.3	1
8GS-12MP	7347-20265	1/2	12.7	3/4-14	1 1/16	—	3.03	77.0	1.56	39.5	1
10GS-8MP	7347-20335	5/8	15.8	1/2-14	15/16	—	3.35	85.0	1.34	34.0	1
10GS-12MP	7347-20355	5/8	15.8	3/4-14	1 1/8	—	3.58	91.0	1.60	40.7	1
12GS-8MP	7347-20425	3/4	19.1	1/2-14	1 1/16	—	3.54	90.0	1.54	39.0	1
12GS-12MP	7347-20445	3/4	19.1	3/4-14	1 1/16	—	3.54	90.0	1.54	39.0	1
12GS-16MP	7347-20465	3/4	19.1	1-11 1/2	1 3/8	—	3.82	97.0	1.81	46.0	1
16GS-12MP	7347-20535	1	25.4	3/4-14	1 3/8	—	3.98	101.0	1.74	44.2	1
16GS-16MP	7347-20555	1	25.4	1-11 1/2	1 3/8	—	4.17	106.0	1.94	49.2	1
16GS-20MP	7347-20565	1	25.4	1 1/4-11 1/2	1 3/4	—	4.29	109.0	2.06	52.2	1
20GS-20MP	7347-20645	1 1/4	31.7	1 1/4-11 1/2	1 3/4	—	5.00	127.0	2.20	55.9	1
24GSP-24MP	7347-20725	1 1/2	38.1	1 1/2-11 1/2	2.00	—	5.24	133.0	2.34	59.4	1
32GSP-32MP	7347-20795	2	50.8	2-11 1/2	2.50	—	6.05	153.7	2.43	61.7	1
<b>BULK PACK</b>											
8GS-8MPXBULK	7347-2024	1/2	12.7	1/2-14	7/8	—	2.91	73.9	1.43	36.3	225
8GS-12MPXBULK	7347-2026	1/2	12.7	3/4-14	1 1/16	—	3.03	77.0	1.56	39.5	150
12GS-12MPXBULK	7347-2044	3/4	19.1	3/4-14	1 1/16	—	3.54	90.0	1.54	39.0	100
12GS-16MPXBULK	7347-2046	3/4	19.1	1-11 1/2	1 3/8	—	3.82	97.0	1.81	46.0	40
16GS-16MPXBULK	7347-2055	1	25.4	1-11 1/2	1 3/8	—	4.17	106.0	1.94	49.2	60
20GS-20MPXBULK	7347-2064	1 1/4	31.7	1 1/4-11 1/2	1 3/4	—	5.00	127.0	2.20	55.9	25
24GSP-24MPXBULK	7347-2072	1 1/2	38.1	1 1/2-11 1/2	2.00	—	5.24	133.0	2.34	59.4	25
32GSP-32MPXBULK	7347-2079	2	50.8	2-11 1/2	2.50	—	6.05	153.7	2.43	61.7	10

## Male Pipe (NPTF - 30° Cone Seat) - API Threads



Descr.	Prod. No.	⊖			H1	H2	L		C		Std. Pack
		"	mm		"	"	"	mm	"	mm	
<b>STANDARD PACK</b>											
20GS-20MPAPI	7347-76955	1 1/4	31.7	1 1/4-11 1/2	1 3/4	—	5.51	140.0	2.70	68.9	1

EQUIPMENT

HOSE/CPLG. SELECTION

GLOBALSPIRAL COUPLINGS

PCM/PCS FERRULES

MEGACRIMP COUPLINGS

POWER CRIMP COUPLINGS

LOW PRESSURE COUPLINGS

POLARSEAL COUPLINGS

C14 COUPLINGS

PCTS THERMO-PLASTIC COUPLINGS

FIELD ATTACHABLE G1 &amp; G2 COUPLINGS

FIELD ATTACHABLE C5 COUPLINGS

SURELOK AIR BRAKE COUPLINGS

QUICK DISCONNECT COUPLERS

NEW BALL VALVES

ACCESSORIES

EQUIPMENT AND PARTS





# GlobalSpiral™ Couplings

EQUIPMENT

HOSE/CPLG. SELECTION

GLOBALSPIRAL COUPLINGS

PCM/PCS FERRULES

MEGACRIMP COUPLINGS

POWER CRIMP COUPLINGS

LOW PRESSURE COUPLINGS

POLARSEAL COUPLINGS

C14 COUPLINGS

PCTS THERMO-PLASTIC COUPLINGS

FIELD ATTACHABLE G1 & G2 COUPLINGS

FIELD ATTACHABLE C5 COUPLINGS

SURELOK AIR BRAKE COUPLINGS

QUICK DISCONNECT COUPLERS

NEW BALL VALVES

ACCESSORIES

EQUIPMENT AND PARTS

## Male Pipe for API Unions

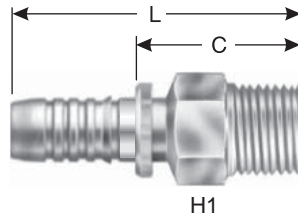

H1

Descr.	Prod. No.	⊖			H1	H2	L		C		Std. Pack
		"	mm				"	mm	"	mm	
<b>STANDARD PACK</b>											
32GSP-32MPAPI	7347-85415	2	50.8	2-11 1/2	2.50	—	7.90	200.6	4.28	108.6	1
<b>BULK PACK</b>											
32GSP-32MPAPIXBULK	7347-8541	2	50.8	2-11 1/2	2.50	—	7.90	200.6	4.28	108.6	10

## Male Pipe (NPTF - 30° Cone Seat) - Long Hex

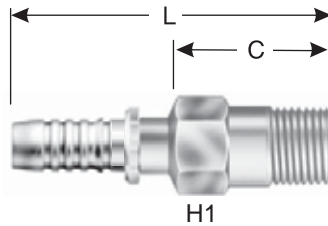

H1

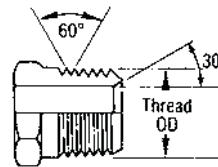

Descr.	Prod. No.	⊖			H1	H2	L		C		Std. Pack
		"	mm				"	mm	"	mm	
<b>STANDARD PACK</b>											
16GS-16MPLH	7347-76545	1	25.4	1-11 1/2	1 3/8	—	5.16	131.0	2.92	74.2	1
<b>BULK PACK</b>											
16GS-16MPLHXBULK	7347-7654	1	25.4	1-11 1/2	1 3/8	—	5.16	131.0	2.92	74.2	45

## Male O-Ring Boss

SAE J1926/2 ISO 11926-2 Heavy Duty (S Series) Stud End.

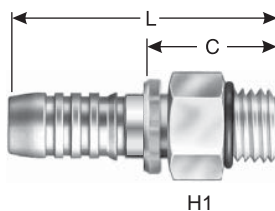

H1

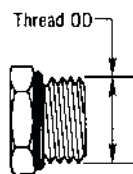

Descr.	Prod. No.	⊖			H1	H2	L		C		Std. Pack
		"	mm				"	mm	"	mm	
<b>STANDARD PACK</b>											
6GS-6MB	7347-21145	3/8	9.5	9/16-18	11/16	—	2.56	65.0	1.15	29.2	1
8GS-8MB	7347-21245	1/2	12.7	3/4-16	7/8	—	2.76	70.0	1.26	32.0	1
8GS-10MB	7347-21255	1/2	12.7	7/8-14	1	—	2.83	72.0	1.34	34.0	1







## Male O-Ring Boss - Cont'd

Descr.	Prod. No.	⊖			H1	H2	L		C		Std. Pack
		"	mm		"	"	"	mm	"	mm	
10GS-10MB	7347-21345	5/8	15.8	7/8-14	1	—	3.46	88.0	1.48	37.7	1
10GS-12MB	7347-21355	5/8	15.8	1 1/16-12	1 1/4	—	3.46	88.0	1.48	37.7	1
12GS-12MB	7347-21445	3/4	19.1	1 1/16-12	1 1/4	—	3.66	93.0	1.65	42.0	1
12GS-16MB	7347-21465	3/4	19.1	1 5/16-12	1 1/2	—	3.54	90.0	1.54	39.0	1
16GS-12MB	7347-21535	1	25.4	1 1/16-12	1 3/8	—	3.98	101.0	1.74	44.2	1
16GS-16MB	7347-21555	1	25.4	1 5/16-12	1 1/2	—	3.86	98.0	1.62	41.2	1
20GS-20MB	7347-21645	1 1/4	31.7	1 5/8-12	1 7/8	—	4.53	115.0	1.73	43.9	1
<b>BULK PACK</b>											
8GS-8MBXBULK	7347-2124	1/2	12.7	3/4-16	7/8	—	2.76	70.0	1.26	32.0	300
12GS-12MBXBULK	7347-2144	3/4	19.1	1 1/16-12	1 1/4	—	3.66	93.0	1.65	42.0	75
16GS-16MBXBULK	7347-2155	1	25.4	1 5/16-12	1 1/2	—	3.86	98.0	1.62	41.2	50

## Female MegaSeal® Swivel

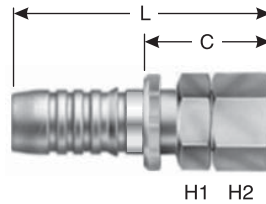
Gates High Performance Replacement for Female JIC Fittings - Connects to Standard Male JIC Termination.



Descr.	Prod. No.	⊖			H1	H2	L		C		Std. Pack
		"	mm		"	"	"	mm	"	mm	
<b>STANDARD PACK</b>											
12GS-12FMX	7347-69445	3/4	19.0	1 1/16-12	1 1/8	1 1/4	4.02	102.0	2.02	51.3	1
12GS-16FMX	7347-69465	3/4	19.0	1 5/16-12	1 1/8	1 1/2	4.06	103.2	2.06	52.2	1
16GS-16FMX	7347-69555	1	25.4	1 5/16-12	1 1/2	1 1/2	4.37	111.0	2.15	54.5	1
20GS-20FMX	7347-69645	1 1/4	31.7	1 5/8-12	1 7/8	2	5.36	136.1	2.56	65.0	1
<b>BULK PACK</b>											
12GS-12FMX XBULK	7347-6944	3/4	19.1	1 1/16-12	1 1/8	1 1/4	4.02	102.0	2.02	51.3	100
12GS-16FMX XBULK	7347-6946	3/4	19.1	1 5/16-12	1 1/8	1 1/2	4.06	103.2	2.06	52.2	30
16GS-16FMX XBULK	7347-6955	1	25.4	1 5/16-12	1 1/2	1 1/2	4.37	111.0	2.15	54.5	50
20GS-20FMX XBULK	7347-6964	1 1/4	31.7	1 5/8-12	1 7/8	2	5.36	136.1	2.56	65.0	25

- EQUIPMENT
- HOSE/CPLG. SELECTION
- GLOBALSPIRAL COUPLINGS
- PCM/PCS FERRULES
- MEGACRIMP COUPLINGS
- POWER CRIMP COUPLINGS
- LOW PRESSURE COUPLINGS
- POLARSEAL COUPLINGS
- C14 COUPLINGS
- PCTS THERMO-PLASTIC COUPLINGS
- FIELD ATTACHABLE G1 & G2 COUPLINGS
- FIELD ATTACHABLE C5 COUPLINGS
- SURELOK AIR BRAKE COUPLINGS
- QUICK DISCONNECT COUPLERS
- NEW BALL VALVES
- ACCESSORIES
- EQUIPMENT AND PARTS





# GlobalSpiral™ Couplings

## Female MegaSeal® Swivel - 45° Bent Tube

Gates High Performance Replacement for Female JIC Fittings - Connects to Standard Male JIC Termination.

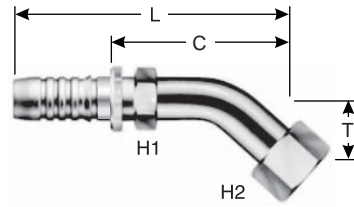

Descr.	Prod. No.	⊖		🌀	H1	H2	T		L		C		Std. Pack
		"	mm		"	"	"	mm	"	mm	"	mm	
<b>STANDARD PACK</b>													
12GS-12FMX45-032	7347-73275	3/4	19.0	1 1/16-12	1 1/8	1 1/4	1.26	32.0	5.08	129.0	3.07	78.0	1
16GS-16FMX45-038	7347-70555	1	25.4	1 5/16-12	1 1/2	1 1/2	1.50	38.0	6.26	159.0	4.04	102.6	1
20GS-20FMX45-041	7347-70645	1 1/4	31.7	1 5/8-12	1 7/8	2	1.61	41.0	7.47	189.7	4.67	118.6	1
<b>BULK PACK</b>													
12GS-12FMX45-032XBULK	7347-7327	3/4	19.1	1 1/16-12	1 1/8	1 1/4	1.26	32.0	5.08	129.0	3.07	78.0	75
16GS-16FMX45-038XBULK	7347-7055	1	25.4	1 5/16-12	1 1/2	1 1/2	1.50	38.0	6.26	159.0	4.04	102.6	25

## Female MegaSeal® Swivel - 90° Bent Tube

Gates High Performance Replacement for Female JIC Fittings - Connects to Standard Male JIC Termination.

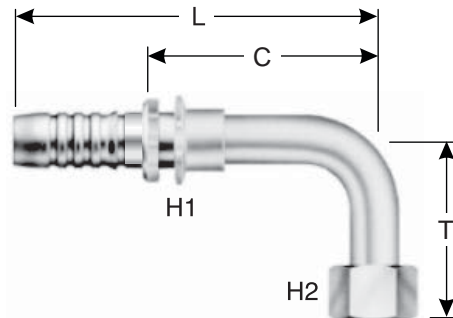

Descr.	Prod. No.	⊖		🌀	H1	H2	T		L		C		Std. Pack
		"	mm		"	"	"	mm	"	mm	"	mm	
<b>STANDARD PACK</b>													
12GS-12FMX90-048	7347-71445	3/4	19.1	1 1/16-12	1 1/8	1 1/4	1.89	48.0	4.72	120.0	2.72	69.0	1
12GS-12FMX90-058	7347-71395	3/4	19.0	1 1/16-12	1 1/8	1 1/4	2.28	58.0	4.72	120.0	2.72	69.0	1
12GS-12FMX90-096	7347-71405	3/4	19.0	1 1/16-12	1 1/8	1 1/4	3.78	96.0	4.72	120.0	2.72	69.0	1
12GS-16FMX90-056	7347-71465	3/4	19.0	1 5/16-12	1 1/8	1 1/2	2.20	56.0	5.39	137.0	3.39	86.0	1
16GS-16FMX90-056	7347-71555	1	25.4	1 5/16-12	1 1/2	1 1/2	2.20	56.0	5.67	144.0	3.45	87.6	1
16GS-16FMX90-071	7347-71505	1	25.4	1 5/16-12	1 1/2	1 1/2	2.80	71.0	5.67	144.0	3.45	87.6	1
<b>BULK PACK</b>													
12GS-12FMX90-048XBULK	7347-7144	3/4	19.1	1 1/16-12	1 1/8	1 1/4	1.89	48.0	4.72	120.0	2.72	69.0	40
12GS-12FMX90-058XBULK	7347-7139	3/4	19.1	1 1/16-12	1 1/8	1 1/4	2.28	58.0	4.72	120.0	2.72	69.0	40
12GS-16FMX90-056XBULK	7347-7146	3/4	19.1	1 5/16-12	1 1/8	1 1/2	2.20	56.0	5.39	137.0	3.39	86.0	40
16GS-16FMX90-056XBULK	7347-7155	1	25.4	1 5/16-12	1 1/2	1 1/2	2.20	56.0	5.67	144.0	3.45	87.6	30





## Male JIC 37° Flare

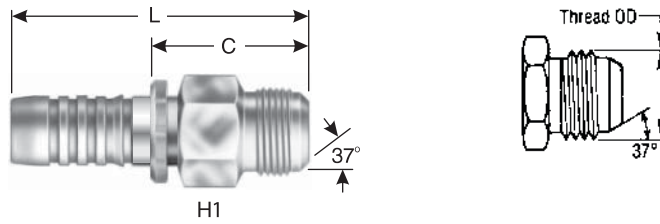

Descr.	Prod. No.	⊖		🌀	H1	H2	L		C		Std. Pack
		"	mm				"	mm	"	mm	
<b>STANDARD PACK</b>											
6GS-6MJ	7347-22145	3/8	9.5	9/16-18	11/16	—	2.60	66.0	1.19	30.2	1
6GS-8MJ	7347-22155	3/8	9.5	3/4-16	13/16	—	2.76	70.0	1.35	34.2	1
6GS-10MJ	7347-22165	3/8	9.5	7/8-14	15/16	—	3.03	77.0	1.62	41.2	1
8GS-8MJ	7347-22245	1/2	12.7	3/4-16	13/16	—	2.83	72.0	1.36	34.5	1
8GS-10MJ	7347-22255	1/2	12.7	7/8-14	7/8	—	2.95	75.0	1.48	37.5	1
10GS-10MJ	7347-22345	5/8	15.8	7/8-14	15/16	—	3.62	92.0	1.64	41.7	1
10GS-12MJ	7347-22355	5/8	15.8	1 1/16-12	1 1/16	—	3.70	94.0	1.72	43.7	1
12GS-12MJ	7347-22445	3/4	19.1	1 1/16-12	1 1/8	—	3.66	93.0	1.65	42.0	1
12GS-14MJ	7347-22455	3/4	19.1	1 3/16-12	1 1/4	—	3.70	94.0	1.69	43.0	1
12GS-16MJ	7347-22465	3/4	19.1	1 5/16-12	1 5/16	—	3.78	96.0	1.77	45.0	1
16GS-16MJ	7347-22555	1	25.4	1 5/16-12	1 3/8	—	4.09	104.0	1.86	47.2	1
16GS-20MJ	7347-22585	1	25.4	1 5/8-12	1 5/8	—	4.27	108.5	2.04	51.7	1
20GS-20MJ	7347-22645	1 1/4	31.7	1 5/8-12	1 3/4	—	4.92	125.0	2.12	53.9	1
24GSP-20MJ	7347-81455	1 1/2	38.1	1 5/8-12	1.97	—	5.00	127.0	2.10	53.7	1
24GSP-24MJ	7347-81465	1 1/2	38.1	1 7/8-12	1.97	—	5.12	130.0	2.22	56.4	1
32GSP-32MJ	7347-81535	2	50.8	2 1/2-12	2.56	—	6.34	161.1	2.72	69.1	1
<b>BULK PACK</b>											
8GS-8MJXBULK	7347-2224	1/2	12.7	3/4-16	13/16	—	2.83	72.0	1.36	34.5	150
8GS-10MJXBULK	7347-2225	1/2	12.7	7/8-14	7/8	—	2.95	75.0	1.48	37.5	200
12GS-12MJXBULK	7347-2244	3/4	19.1	1 1/16-12	1 1/8	—	3.66	93.0	1.65	42.0	125
12GS-16MJXBULK	7347-2246	3/4	19.1	1 5/16-12	1 5/16	—	3.78	96.0	1.77	45.0	50
16GS-16MJXBULK	7347-2255	1	25.4	1 5/16-12	1 3/8	—	4.09	104.0	1.86	47.2	50
20GS-20MJXBULK	7347-2264	1 1/4	31.7	1 5/8-12	1 3/4	—	4.92	125.0	2.12	53.9	30
24GSP-24MJXBULK	7347-8146	1 1/2	38.1	1 7/8-12	1.97	—	5.12	130.0	2.22	56.4	20
32GSP-32MJXBULK	7347-8153	2	50.8	2 1/2-12	2.56	—	6.34	161.1	2.72	69.1	5

## Female JIC 37° Flare Swivel

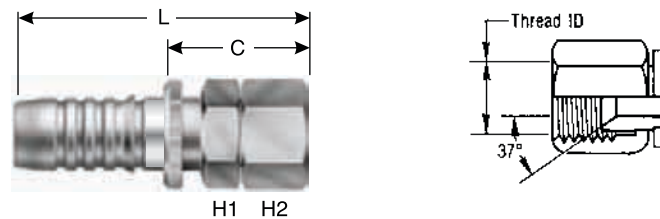

Descr.	Prod. No.	⊖		🌀	H1	H2	L		C		Std. Pack
		"	mm				"	mm	"	mm	
<b>STANDARD PACK</b>											
	7347-82455	1 1/2	38.1	1 7/8-12	1.97	2.36	5.64	143.4	2.74	69.7	1
6GS-6FJX	7347-24145	3/8	9.5	9/16-18	3/4	3/4	2.72	69.0	1.31	33.2	1

- EQUIPMENT
- HOSE/CPLG. SELECTION
- GLOBALSPIRAL COUPLINGS**
- PCM/PCS FERRULES
- MEGACRIMP COUPLINGS
- POWER CRIMP COUPLINGS
- LOW PRESSURE COUPLINGS
- POLARSEAL COUPLINGS
- C14 COUPLINGS
- PCTS THERMO-PLASTIC COUPLINGS
- FIELD ATTACHABLE G1 & G2 COUPLINGS
- FIELD ATTACHABLE C5 COUPLINGS
- SURELOK AIR BRAKE COUPLINGS
- QUICK DISCONNECT COUPLERS
- NEW BALL VALVES
- ACCESSORIES
- EQUIPMENT AND PARTS



# GlobalSpiral™ Couplings



## Female JIC 37° Flare Swivel - Cont'd

DESCR.	PROD. NO.	Ø			H1	H2	L		C		STD. PACK
		"	mm		"	"	"	mm	"	mm	
6GS-8FJX	7347-24155	3/8	9.5	3/4-16	3/4	7/8	2.80	71.0	1.39	35.2	1
8GS-8FJX	7347-24245	1/2	12.7	3/4-16	7/8	7/8	2.83	72.0	1.36	34.5	1
8GS-10FJX	7347-24255	1/2	12.7	7/8-14	7/8	1 1/16	2.99	75.9	1.51	38.4	1
8GS-12FJX	7347-24265	1/2	12.7	1 1/16-12	7/8	1 1/4	3.03	77.0	1.56	39.5	1
10GS-10FJX	7347-82175	5/8	15.8	7/8-14	1	1 1/16	3.68	93.5	1.70	43.2	1
10GS-12FJX	7347-24355	5/8	15.8	1 1/16-12	1	1 1/4	3.74	95.0	1.76	44.7	1
12GS-10FJX	7347-24435	3/4	19.1	7/8-14	1 1/16	1 1/8	3.87	98.4	1.87	47.4	1
12GS-12FJX	7347-24445	3/4	19.1	1 1/16-12	1	1 1/4	3.87	98.2	1.86	47.2	1
12GS-14FJX	7347-24455	3/4	19.1	1 3/16-12	1 1/8	1 3/8	4.06	103.2	2.06	52.2	1
12GS-16FJX	7347-24465	3/4	19.1	1 5/16-12	1 1/4	1 1/2	4.02	102.0	2.01	51.0	1
16GS-12FJX	7347-24535	1	25.4	1 1/16-12	1 3/8	1 3/8	4.25	107.9	2.00	50.7	1
16GS-14FJX	7347-24545	1	25.4	1 3/16-12	1 3/8	1 1/2	4.25	107.9	2.01	51.1	1
16GS-16FJX	7347-24555	1	25.4	1 5/16-12	1 1/2	1 1/2	4.30	109.2	2.07	52.6	1
16GS-20FJX	7347-24565	1	25.4	1 5/8-12	1 1/2	2	4.53	115.0	2.31	58.6	1
20GS-16FJX	7347-24635	1 1/4	31.7	1 5/16-12	1 3/4	1 5/8	5.08	129.0	2.28	57.9	1
20GS-20FJX	7347-24645	1 1/4	31.7	1 5/8-12	1 7/8	2	5.29	134.4	2.56	64.9	1
20GS-24FJX	7347-24655	1 1/4	31.7	1 7/8-12	1 7/8	2 3/8	5.39	137.0	2.59	65.9	1
32GSP-32FJX	7347-82525	2	50.8	2 1/2-12	2.56	2.95	6.80	172.6	3.17	80.6	1
<b>BULK PACK</b>											
6GS-6FJX XBULK	7347-2414	3/8	9.5	9/16-18	3/4	3/4	2.72	69.0	1.31	33.2	325
6GS-8FJX XBULK	7347-2415	3/8	9.5	3/4-16	3/4	7/8	2.80	71.0	1.39	35.2	200
8GS-8FJX XBULK	7347-2424	1/2	12.7	3/4-16	7/8	7/8	2.83	72.0	1.36	34.5	250
8GS-10FJX XBULK	7347-2425	1/2	12.7	7/8-14	7/8	1 1/16	2.99	75.9	1.51	38.4	175
8GS-12FJX XBULK	7347-2426	1/2	12.7	1 1/16-12	7/8	1 1/4	3.03	77.0	1.56	39.5	175
10GS-10FJX XBULK	7347-8217	5/8	15.8	7/8-14	1	1 1/16	3.68	93.5	1.70	43.2	130
12GS-10FJX XBULK	7347-2443	3/4	19.1	7/8-14	1 1/16	1 1/8	3.87	98.4	1.87	47.4	100
12GS-12FJX XBULK	7347-2444	3/4	19.1	1 1/16-12	1	1 1/4	3.87	98.2	1.86	47.2	100
12GS-14FJX XBULK	7347-2445	3/4	19.1	1 3/16-12	1 1/8	1 3/8	4.06	103.2	2.06	52.2	80
12GS-16FJX XBULK	7347-2446	3/4	19.1	1 5/16-12	1 1/4	1 1/2	4.02	102.0	2.01	51.0	50
16GS-12FJX XBULK	7347-2453	1	25.4	1 1/16-12	1 3/8	1 3/8	4.25	107.9	2.00	50.7	25
16GS-16FJX XBULK	7347-2455	1	25.4	1 5/16-12	1 1/2	1 1/2	4.30	109.2	2.07	52.6	50
16GS-20FJX XBULK	7347-2456	1	25.4	1 5/8-12	1 1/2	2	4.53	115.0	2.31	58.6	30
20GS-20FJX XBULK	7347-2464	1 1/4	31.7	1 5/8-12	1 7/8	2	5.29	134.4	2.56	64.9	25
20GS-24FJX XBULK	7347-2465	1 1/4	31.7	1 7/8-12	1 7/8	2 3/8	5.39	137.0	2.59	65.9	25
24GSP-24FJX XBULK	7347-8245	1 1/2	38.1	1 7/8-12	1.97	2.36	5.64	143.4	2.74	69.7	20
32GSP-32FJX XBULK	7347-8252	2	50.8	2 1/2-12	2.56	2.95	6.80	172.6	3.17	80.6	9

EQUIPMENT

HOSE/CPLG. SELECTION

GLOBALSPIRAL COUPLINGS

PCM/PCS FERRULES

MEGACRIMP COUPLINGS

POWER CRIMP COUPLINGS

LOW PRESSURE COUPLINGS

POLARSEAL COUPLINGS

C14 COUPLINGS

PCTS THERMO-PLASTIC COUPLINGS

FIELD ATTACHABLE G1 &amp; G2 COUPLINGS

FIELD ATTACHABLE C5 COUPLINGS

SURELOK AIR BRAKE COUPLINGS

QUICK DISCONNECT COUPLERS

NEW BALL VALVES

ACCESSORIES

EQUIPMENT AND PARTS





## Female JIC 37° Flare Swivel - 30° Bent Tube

S, M and L Drops per ISO Final Draft International Standard 12151-S.

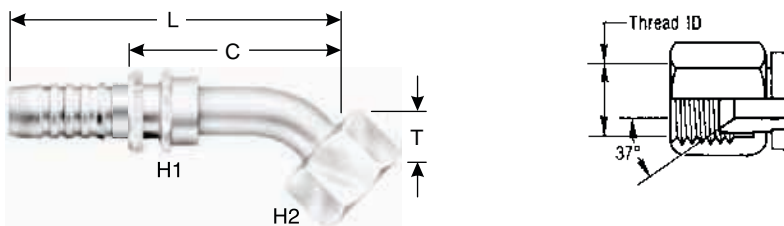

Descr.	Prod. No.	Ø			H1	H2	T		L		C		Std. Pack
		"	mm		"	"	"	mm	"	mm	"	mm	
<b>STANDARD PACK</b>													
16GS-16FJX30M	7347-73055	1	25.4	1 5/16-12	1 7/8	1 1/2	1.06	27.0	6.02	153.0	3.80	96.6	1

## Female JIC 37° Flare Swivel - 45° Short Bent Tube

S, M and L Drops per ISO Final Draft International Standard 12151-S.

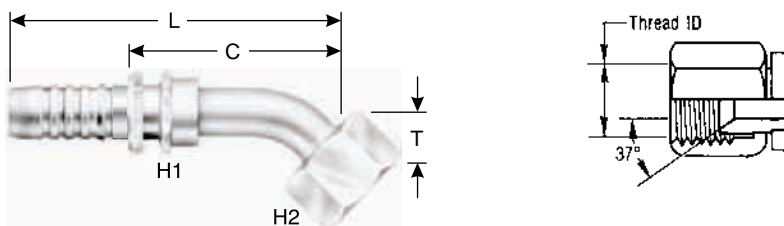

Descr.	Prod. No.	Ø			H1	H2	T		L		C		Std. Pack
		"	mm		"	"	"	mm	"	mm	"	mm	
<b>STANDARD PACK</b>													
6GS-6FJX45S	7347-25145	3/8	9.5	9/16-18	3/4	3/4	.43	11.0	3.23	82.0	1.82	46.2	1
6GS-8FJX45S	7347-25155	3/8	9.5	3/4-16	3/4	7/8	.59	15.0	3.66	93.0	2.25	57.2	1
8GS-8FJX45S	7347-25245	1/2	12.7	3/4-16	7/8	7/8	.59	15.0	3.70	94.0	2.22	56.5	1
8GS-10FJX45S	7347-25255	1/2	12.7	7/8-14	7/8	1 1/16	.63	16.0	3.58	91.0	2.11	53.5	1
10GS-12FJX45S	7347-25355	5/8	15.8	1 1/16-12	1	1 1/4	.83	21.0	4.80	122.0	2.82	71.7	1
12GS-12FJX45S	7347-25445	3/4	19.1	1 1/16-12	1 1/8	1 1/4	.83	21.0	5.12	130.0	3.11	79.0	1
12GS-16FJX45S	7347-25465	3/4	19.1	1 5/16-12	1 1/8	1 1/2	.94	24.0	5.39	137.0	3.39	86.0	1
16GS-16FJX45S	7347-25555	1	25.4	1 5/16-12	1 1/2	1 1/2	.94	24.0	5.98	152.0	3.77	95.7	1
16GS-20FJX45S	7347-25565	1	25.4	1 5/8-12	1 1/2	2	.98	25.0	6.46	164.0	4.23	107.5	1
<b>BULK PACK</b>													
8GS-8FJX45SXBULK	7347-2524	1/2	12.7	3/4-16	7/8	7/8	.59	15.0	3.70	94.0	2.22	56.5	90
8GS-10FJX45SXBULK	7347-2525	1/2	12.7	7/8-14	7/8	1 1/16	.63	16.0	3.58	91.0	2.11	53.5	75
12GS-12FJX45SXBULK	7347-2544	3/4	19.1	1 1/16-12	1 1/8	1 1/4	.83	21.0	5.12	130.0	3.11	79.0	40
12GS-16FJX45SXBULK	7347-2546	3/4	19.1	1 5/16-12	1 1/8	1 1/2	.94	24.0	5.39	137.0	3.39	86.0	50
16GS-16FJX45SXBULK	7347-2555	1	25.4	1 5/16-12	1 1/2	1 1/2	.94	24.0	5.98	152.0	3.77	95.7	35

EQUIPMENT

HOSE/CPLG. SELECTION

GLOBALSPIRAL COUPLINGS

PCM/PCS FERRULES

MEGACRIMP COUPLINGS

POWER CRIMP COUPLINGS

LOW PRESSURE COUPLINGS

POLARSEAL COUPLINGS

C14 COUPLINGS

PCTS THERMO-PLASTIC COUPLINGS

FIELD ATTACHABLE G1 & G2 COUPLINGS

FIELD ATTACHABLE C5 COUPLINGS

SURELOK AIR BRAKE COUPLINGS

QUICK DISCONNECT COUPLERS

NEW BALL VALVES

ACCESSORIES

EQUIPMENT AND PARTS





# GlobalSpiral™ Couplings

## Female JIC 37° Flare Swivel - 45° Medium Bent Tube

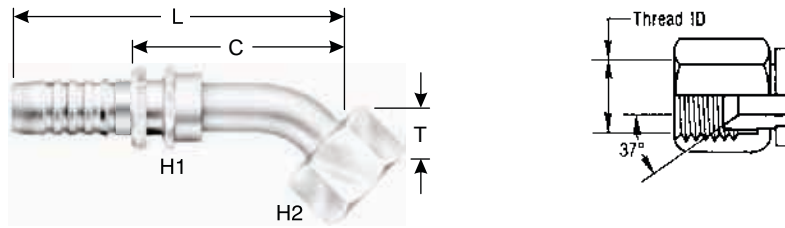

Descr.	Prod. No.	⊖		🌀	H1	H2	T	L		C		Std. Pack	
		"	mm		"	"	"	mm	"	mm	"		mm
<b>STANDARD PACK</b>													
10GS-10FJX45-018	7347-83275	5/8	15.8	7/8-14	1 3/16	1 1/16	.71	18.0	4.45	113.0	2.48	63.0	1
16GS-16FJX45M	7347-26555	1	25.4	1 5/16-12	1 1/2	1 1/2	1.50	38.0	6.30	160.0	4.07	103.4	1
20GS-20FJX45-038	7347-76175	1 1/4	31.7	1 5/8-12	1 7/8	2	1.50	38.0	7.09	180.0	4.29	108.9	1
24GSP-24FJX45-050	7347-83735	1 1/2	38.1	1 7/8-12	2.16	2.36	1.97	50.0	9.17	233.0	6.28	159.5	1
<b>BULK PACK</b>													
10GS-10FJX45-018XBULK	7347-8327	5/8	15.8	7/8-14	1 3/16	1 1/16	1.71	18.0	4.45	113.0	2.48	63.0	100
16GS-16FJX45MXBULK	7347-2655	1	25.4	1 5/16-12	1 1/2	1 1/2	1.50	38.0	6.30	160.0	4.07	103.4	25
20GS-20FJX45-038XBULK	7347-7617	1 1/4	31.7	1 5/8-12	1 7/8	2	1.50	38.0	7.09	180.0	4.29	108.9	15
24GSP-24FJX45M XBULK	7347-8373	1 1/2	38.1	1 7/8-12	2.16	2.36	1.97	50.0	9.17	233.0	6.28	159.5	10

## Female JIC 37° Flare Swivel - 60° Bent Tube

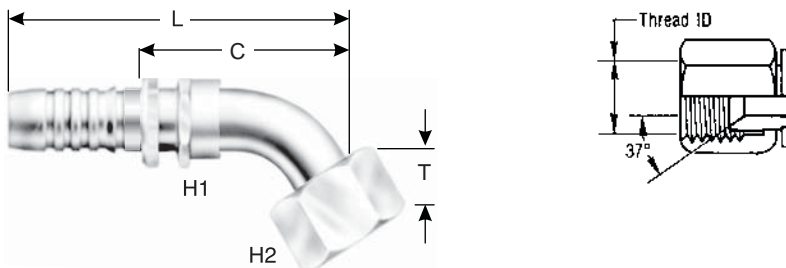

Descr.	Prod. No.	⊖		🌀	H1	H2	T	L		C		Std. Pack	
		"	mm		"	"	"	mm	"	mm	"		mm
<b>STANDARD PACK</b>													
12GS-12FJX60-043	7347-76795	3/4	19.1	1 1/16-12	1 1/8	1 1/4	1.69	43.0	5.59	142.0	3.58	91.0	1





## Female JIC 37° Flare Swivel - 90° Bent Tube

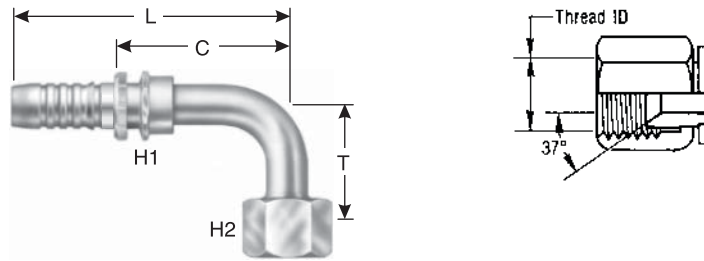

Descr.	Prod. No.	⊖		🌀	H1	H2	T	L		C		Std. Pack	
		"	mm					"	mm	"	mm		
<b>STANDARD PACK</b>													
10GS-10FJX90-036	7347-84275	5/8	15.8	7/8-14	1 3/16	1 1/16	1.42	36.0	4.37	111.0	1.70	43.3	1
24GSP-24FJX90-089	7347-84745	1 1/2	38.1	1 7/8-12	2.16	2.36	3.50	89.0	8.35	212.0	5.45	138.4	1
24GSP-24FJX90-118	7347-84755	1 1/2	38.1	1 7/8-12	2.16	2.36	4.65	118.0	7.46	189.5	4.56	115.8	1
<b>BULK PACK</b>													
10GS-10FJX90-036XBULK	7347-8427	5/8	15.8	7/8-14	1 3/16	1 1/16	1.42	36.0	4.37	111.0	1.70	43.3	100
24GSP-24FJX90 XBULK	7347-8475	1 1/2	38.1	1 7/8-12	2.16	2.36	4.65	118.0	7.46	189.5	4.56	115.8	10
24GSP-24FJX90S XBULK	7347-8474	1 1/2	38.1	1 7/8-12	2.16	2.36	3.50	89.0	8.35	212.0	5.45	138.4	10

## Female JIC 37° Flare Swivel - 90° Short Bent Tube

S, M and L Drops per ISO Final Draft International Standard 12151-S.

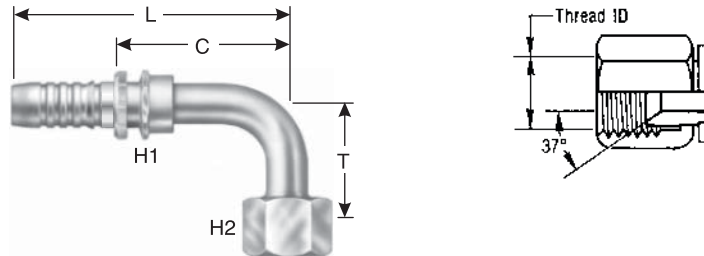

Descr.	Prod. No.	⊖		🌀	H1	H2	T	L		C		Std. Pack	
		"	mm					"	mm	"	mm		
<b>STANDARD PACK</b>													
6GS-6FJX90S	7347-27145	3/8	9.5	9/16-18	3/4	3/4	.91	23.0	3.11	79.0	1.70	43.2	1
8GS-8FJX90S	7347-27245	1/2	12.7	3/4-16	7/8	7/8	1.14	29.0	3.39	86.0	1.91	48.6	1
8GS-10FJX90S	7347-27255	1/2	12.7	7/8-14	7/8	1 1/16	1.26	32.0	3.62	92.0	2.15	54.5	1
8GS-12FJX90S	7347-27265	1/2	12.7	1 1/16-12	7/8	1 1/4	1.89	48.0	4.37	111.0	2.89	73.5	1
10GS-10FJX90S	7347-27345	5/8	15.8	7/8-14	1	1 1/16	1.26	32.0	4.21	107.0	2.24	56.8	1
12GS-12FJX90S	7347-27445	3/4	19.1	1 1/16-12	1 1/8	1 1/4	1.89	48.0	4.45	113.0	2.44	62.0	1
12GS-16FJX90S	7347-27465	3/4	19.1	1 5/16-12	1 1/8	1 1/2	2.20	56.0	5.31	135.0	3.31	84.0	1
16GS-16FJX90S	7347-27555	1	25.4	1 5/16-12	1 7/8	1 1/2	2.20	56.0	5.67	144.0	3.45	87.6	1
20GS-20FJX90S	7347-27645	1 1/4	31.7	1 5/8-12	1 7/8	2	2.52	64.0	6.85	174.0	4.05	102.9	1
<b>BULK PACK</b>													
8GS-8FJX90SXBULK	7347-2724	1/2	12.7	3/4-16	7/8	7/8	1.14	29.0	3.39	86.0	1.91	48.6	170
8GS-10FJX90SXBULK	7347-2725	1/2	12.7	7/8-14	7/8	1 1/16	1.26	32.0	3.62	92.0	2.15	54.5	125
8GS-12FJX90SXBULK	7347-2726	1/2	12.7	1 1/16-12	7/8	1 1/4	1.89	48.0	4.37	111.0	2.89	73.5	75
10GS-10FJX90SXBULK	7347-2734	5/8	15.8	7/8-14	1	1 1/16	1.26	32.0	4.21	107.0	2.24	56.8	100
12GS-12FJX90SXBULK	7347-2744	3/4	19.1	1 1/16-12	1 1/8	1 1/4	1.89	48.0	4.45	113.0	2.44	62.0	50
16GS-16FJX90SXBULK	7347-2755	1	25.4	1 5/16-12	1 7/8	1 1/2	2.20	56.0	5.67	144.0	3.45	87.6	25

EQUIPMENT

HOSE/CPLG. SELECTION

GLOBALSPIRAL COUPLINGS

PCM/PCS FERRULES

MEGACRIMP COUPLINGS

POWER CRIMP COUPLINGS

LOW PRESSURE COUPLINGS

POLARSEAL COUPLINGS

C14 COUPLINGS

PCTS THERMO-PLASTIC COUPLINGS

FIELD ATTACHABLE G1 & G2 COUPLINGS

FIELD ATTACHABLE C5 COUPLINGS

SURELOK AIR BRAKE COUPLINGS

QUICK DISCONNECT COUPLERS

NEW BALL VALVES

ACCESSORIES

EQUIPMENT AND PARTS



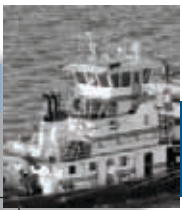

# GlobalSpiral™ Couplings

EQUIPMENT

HOSE/CPLG. SELECTION

GLOBALSPIRAL COUPLINGS

PCM/PCS FERRULES

MEGACRIMP COUPLINGS

POWER CRIMP COUPLINGS

LOW PRESSURE COUPLINGS

POLARSEAL COUPLINGS

C14 COUPLINGS

PCTS THERMO-PLASTIC COUPLINGS

FIELD ATTACHABLE G1 & G2 COUPLINGS

FIELD ATTACHABLE C5 COUPLINGS

SURELOK AIR BRAKE COUPLINGS

QUICK DISCONNECT COUPLERS

NEW BALL VALVES

ACCESSORIES

EQUIPMENT AND PARTS

## Female JIC 37° Flare Swivel - 90° Short Bent Tube - Cont'd

Descr.	Prod. No.	⊖			H1	H2	T		L		C		Std. Pack
		"	mm		"	"	"	mm	"	mm	"	mm	
20GS-20FJX90SX BULK	7347-2764	1 1/4	31.7	1 5/8-12	1 7/8	2	2.52	64.0	6.85	174.0	4.05	102.9	20

## Female JIC 37° Flare Swivel - 90° Medium Bent Tube

S, M and L Drops per ISO Final Draft International Standard 12151-S.

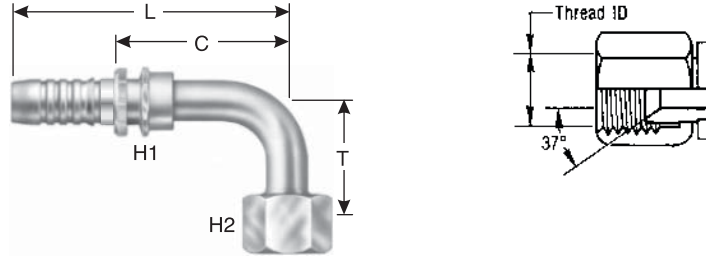

Descr.	Prod. No.	⊖			H1	H2	T		L		C		Std. Pack
		"	mm		"	"	"	mm	"	mm	"	mm	
<b>STANDARD PACK</b>													
6GS-6FJX90M	7347-84045	3/8	9.5	9/16-18	7/8	3/4	1.50	38.0	3.11	79.0	1.70	43.2	1
6GS-8FJX90M	7347-28155	3/8	9.5	3/4-16	3/4	7/8	1.61	41.0	3.58	91.0	2.17	55.2	1
8GS-8FJX90M	7347-28245	1/2	12.7	3/4-16	7/8	7/8	1.61	41.0	3.62	92.0	2.15	54.6	1
8GS-10FJX90M	7347-28165	1/2	12.7	7/8-14	7/8	1 1/16	1.85	47.0	3.50	89.0	2.01	51.0	1
10GS-10FJX90M	7347-84285	5/8	15.8	7/8-14	1	1 1/16	1.85	47.0	4.21	107.0	2.23	56.7	1
10GS-12FJX90M	7347-28355	5/8	15.8	1 1/16-12	1	1 1/4	2.28	58.0	4.76	121.0	2.78	70.7	1
12GS-12FJX90M	7347-28445	3/4	19.1	1 1/16-12	1 1/8	1 1/4	2.28	58.0	4.45	113.0	2.44	62.0	1
12GS-14FJX90-060	7347-28455	3/4	19.1	1 3/16-12	1 1/8	1 3/8	2.36	60.0	5.55	141.0	3.54	90.0	1
12GS-16FJX90M	7347-28465	3/4	19.1	1 5/16-12	1 1/8	1 1/2	2.80	71.0	5.31	135.0	3.31	84.0	1
16GS-16FJX90M	7347-28555	1	25.4	1 5/16-12	1 1/2	1 1/2	2.80	71.0	5.67	144.0	3.45	87.6	1
20GS-20FJX90M	7347-28645	1 1/4	31.7	1 5/8-12	1 7/8	2	3.07	78.0	6.85	174.0	4.05	102.9	1
20GS-24FJX90M	7347-28655	1 1/4	31.7	1 7/8-12	1 7/8	2 3/8	3.39	86.0	7.32	186.0	4.52	114.9	1
<b>BULK PACK</b>													
8GS-8FJX90MxBULK	7347-2824	1/2	12.7	3/4-16	7/8	7/8	1.61	41.0	3.62	92.0	2.15	54.6	125
8GS-10FJX90MxBULK	7347-2816	1/2	12.7	7/8-14	7/8	1 1/16	1.85	47.0	3.50	89.0	2.01	51.0	125
10GS-10FJX90MxBULK	7347-8428	5/8	15.8	7/8-14	1	1 1/16	1.85	47.0	4.21	107.0	2.23	56.7	75
12GS-12FJX90MxBULK	7347-2844	3/4	19.1	1 1/16-12	1 1/8	1 1/4	2.28	58.0	4.45	113.0	2.44	62.0	55
16GS-16FJX90MxBULK	7347-2855	1	25.4	1 5/16-12	1 1/2	1 1/2	2.80	71.0	5.67	144.0	3.45	87.6	30
20GS-20FJX90MxBULK	7347-2864	1 1/4	31.7	1 5/8-12	1 7/8	2	3.07	78.0	6.85	174.0	4.05	102.9	20





## Female JIC 37° Flare Swivel - 90° Long Bent Tube

S, M and L Drops per ISO Final Draft International Standard 12151-S.

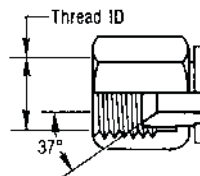
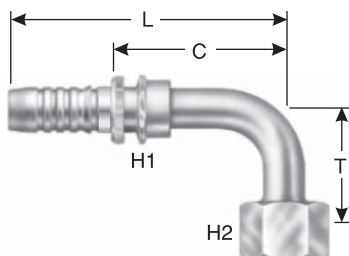

Descr.	Prod. No.	⊖		🌀	H1	H2	T		L		C		Std. Pack
		"	mm				"	mm	"	mm	"	mm	
<b>STANDARD PACK</b>													
6GS-6FJX90L	7347-29145	3/8	9.5	9/16-18	3/4	3/4	2.13	54.0	3.39	86.0	1.98	50.2	1
8GS-8FJX90L	7347-29245	1/2	12.7	3/4-16	7/8	7/8	2.52	64.0	3.62	92.0	2.15	54.6	1
8GS-10FJX90L	7347-29255	1/2	12.7	7/8-14	7/8	1 1/16	3.27	83.0	3.74	95.0	2.26	57.5	1
12GS-12FJX90L	7347-29445	3/4	19.1	1 1/16-12	1 1/8	1 1/4	3.78	96.0	4.45	113.0	2.44	62.0	1
12GS-16FJX90L	7347-29465	3/4	19.1	1 5/16-12	1 1/8	1 1/2	4.49	114.0	5.32	135.0	3.31	84.0	1
16GS-16FJX90L	7347-29555	1	25.4	1 5/16-12	1 1/2	1 1/2	4.33	110.0	5.67	144.0	3.45	87.6	1
16GS-20FJX90L	7347-29565	1	25.4	1 5/8-12	1 1/2	2	5.08	129.0	6.06	154.0	3.84	97.6	1
20GS-20FJX90L	7347-29645	1 1/4	31.7	1 5/8-12	1 7/8	2	5.08	129.0	6.85	174.0	4.05	102.9	1
<b>BULK PACK</b>													
8GS-8FJX90LXBULK	7347-2924	1/2	12.7	3/4-16	7/8	7/8	2.52	64.0	3.62	92.0	2.15	54.6	100
8GS-10FJX90LXBULK	7347-2925	1/2	12.7	7/8-14	7/8	1 1/16	3.27	83.0	3.74	95.0	2.26	57.5	75
12GS-12FJX90LXBULK	7347-2944	3/4	19.1	1 1/16-12	1 1/8	1 1/4	3.78	96.0	4.45	113.0	2.44	62.0	25
16GS-16FJX90LXBULK	7347-2955	1	25.4	1 5/16-12	1 1/2	1 1/2	4.33	110.0	5.67	144.0	3.45	87.6	25
16GS-20FJX90LXBULK	7347-2956	1	25.4	1 5/8-12	1 1/2	2	5.08	129.0	6.06	154.0	3.84	97.6	20

## Female JIC 37° Flare Swivel - 90° Extra Long Bent Tube

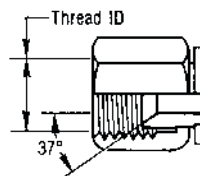
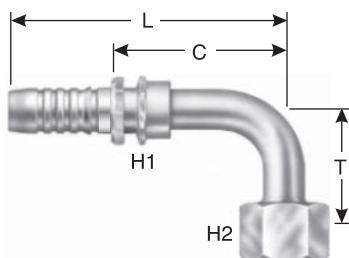

Descr.	Prod. No.	⊖		🌀	H1	H2	T		L		C		Std. Pack
		"	mm				"	mm	"	mm	"	mm	
<b>STANDARD PACK</b>													
6GS-8FJX90-083	7347-76785	3/8	9.5	3/4-16	3/4	7/8	3.27	83.0	3.58	91.0	2.17	55.2	1
8GS-8FJX90XL	7347-73065	1/2	12.7	3/4-16	7/8	7/8	4.06	103.0	3.62	92.0	2.15	54.6	1

EQUIPMENT

HOSE/CPLG. SELECTION

GLOBALSPIRAL COUPLINGS

PCM/PCS FERRULES

MEGACRIMP COUPLINGS

POWER CRIMP COUPLINGS

LOW PRESSURE COUPLINGS

POLARSEAL COUPLINGS

C14 COUPLINGS

PCTS THERMO-PLASTIC COUPLINGS

FIELD ATTACHABLE G1 & G2 COUPLINGS

FIELD ATTACHABLE C5 COUPLINGS

SURELOK AIR BRAKE COUPLINGS

QUICK DISCONNECT COUPLERS

NEW BALL VALVES

ACCESSORIES

EQUIPMENT AND PARTS





EQUIPMENT

HOSE/CPLG. SELECTION

GLOBALSPIRAL COUPLINGS

PCM/PCS FERRULES

MEGACRIMP COUPLINGS

POWER CRIMP COUPLINGS

LOW PRESSURE COUPLINGS

POLARSEAL COUPLINGS

C14 COUPLINGS

PCTS THERMO-PLASTIC COUPLINGS

FIELD ATTACHABLE G1 &amp; G2 COUPLINGS

FIELD ATTACHABLE C5 COUPLINGS

SURELOK AIR BRAKE COUPLINGS

QUICK DISCONNECT COUPLERS

NEW BALL VALVES

ACCESSORIES

EQUIPMENT AND PARTS

## Male Flat-Face O-Ring

Includes Peroxide-cured O-Ring  
Metric Hex per ISO Draft International Standard 12151-1.  
Utilizes SAE J1453 Captive O-Ring Groove for Improved O-Ring Retention.

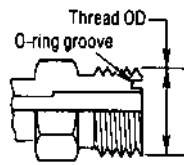
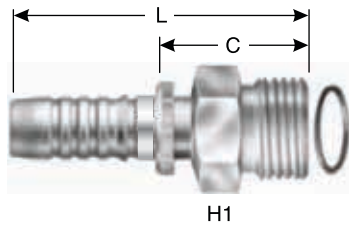

H1

Descr.	Prod. No.	⊖			H1	H2	L		C		Std. Pack
		"	mm		mm	mm	"	mm	"	mm	
<b>STANDARD PACK</b>											
6GS-6MFFOR	7347-23865	3/8	9.5	11/16-16	19.0	—	2.52	64.0	1.11	28.2	1
8GS-8MFFOR	7347-23825	1/2	12.7	13/16-16	22.0	—	2.68	68.0	1.20	30.5	1
8GS-10MFFOR	7347-23895	1/2	12.7	1-14	27.0	—	2.91	74.0	1.44	36.5	1
10GS-10MFFOR	7347-23875	5/8	15.8	1-14	27.0	—	3.42	87.0	1.44	36.7	1
10GS-12MFFOR	7347-23885	5/8	15.8	1 3/16-12	32.0	—	3.50	89.0	1.52	38.7	1
12GS-12MFFOR	7347-23835	3/4	19.1	1 3/16-12	32.0	—	3.50	89.0	1.50	38.0	1
12GS-16MFFOR	7347-23845	3/4	19.1	1 7/16-12	41.0	—	3.74	95.0	1.73	44.0	1
16GS-16MFFOR	7347-23815	1	25.4	1 7/16-12	41.0	—	4.02	102.0	1.78	45.2	1
20GS-20MFFOR	7347-23855	1 1/4	31.7	1 11/16-12	12.7	—	4.72	120.0	1.93	48.9	1
24GSP-24MFFOR	7347-23905	1 1/2	38.1	2-12	55.0	—	5.12	130.0	2.22	56.4	1
<b>BULK PACK</b>											
8GS-8MFFORXBULK	7347-2382	1/2	12.7	13/16-16	22.0	—	2.68	68.0	1.20	30.5	100
12GS-12MFFORXBULK	7347-2383	3/4	19.1	1 3/16-12	32.0	—	3.50	89.0	1.50	38.0	60
16GS-16MFFORXBULK	7347-2381	1	25.4	1 7/16-12	41.0	—	4.02	102.0	1.78	45.2	50
24GSP-24MFFOR XBULK	7347-2390	1 1/2	38.1	2-12	55.0	—	5.12	130.0	2.22	56.4	35

## Female Flat-Face O-Ring Swivel

Metric Hex per ISO Draft International Standard 12151-1.  
SAE J1453 O-Ring Face Seal.

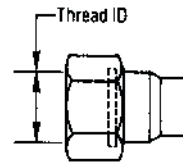
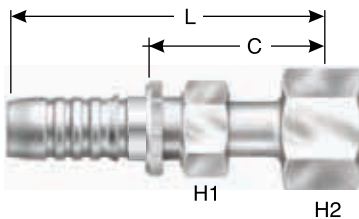

H1

H2

Descr.	Prod. No.	⊖			H1	H2	L		C		Std. Pack
		"	mm		mm	mm	"	mm	"	mm	
<b>STANDARD PACK</b>											
6GS-6FFORX	7347-30145	3/8	9.5	11/16-16	22.0	22.0	2.72	69.0	1.31	33.2	1
6GS-8FFORX	7347-30155	3/8	9.5	13/16-16	22.0	24.0	2.83	72.0	1.43	36.2	1
8GS-8FFORX	7347-30245	1/2	12.7	13/16-16	27.0	24.0	2.87	73.0	1.40	35.5	1
8GS-10FFORX	7347-30255	1/2	12.7	1-14	27.0	30.0	3.07	78.0	1.59	40.5	1
8GS-12FFORX	7347-30265	1/2	12.7	1 3/16-12	27.0	36.0	3.11	79.0	1.63	41.5	1
10GS-10FFORX	7347-30345	5/8	15.8	1-14	30.0	30.0	3.70	94.0	1.72	43.7	1
10GS-12FFORX	7347-30355	5/8	15.8	1 3/16-12	30.0	36.0	3.74	95.0	1.76	44.7	1







## Female Flat-Face O-Ring Swivel - Cont'd

Descr.	Prod. No.	⊖			H1	H2	L		C		Std. Pack
		"	mm		mm	mm	"	mm	"	mm	
12GS-10FFORX	7347-30435	3/4	19.1	1-14	32.0	30.0	3.82	97.0	1.81	46.0	1
12GS-12FFORX	7347-30445	1	25.4	1 3/16-12	32.0	36.0	1.95	99.0	1.89	48.0	1
12GS-16FFORX	7347-30465	1	25.4	1 7/16-12	32.0	41.0	4.06	103.0	2.05	52.0	1
12GS-20FFORX	7347-30475	3/4	6.4	1 11/16-12	32.0	50.0	3.91	99.3	1.90	48.3	1
16GS-12FFORX	7347-30535	1	25.4	1 3/16-12	36.0	36.0	5.15	131.0	2.92	74.2	1
16GS-16FFORX	7347-30555	1	25.4	1 7/16-12	41.0	41.0	4.36	110.8	2.14	54.4	1
16GS-20FFORX	7347-30565	1	25.4	1 11/16-12	41.0	50.0	4.36	110.7	2.14	54.3	1
20GS-20FFORX	7347-30645	1 1/4	31.7	1 11/16-12	50.0	50.0	5.04	128.0	2.24	56.9	1
20GS-24FFORX	7347-30655	1 1/4	31.7	2-12	50.0	60.0	5.12	130.0	2.32	58.9	1
<b>BULK PACK</b>											
6GS-6FFORX XBULK	7347-3014	3/8	9.5	11/16-16	22.0	22.0	2.72	69.0	1.31	33.2	250
6GS-8FFORX XBULK	7347-3015	3/8	9.5	13/16-16	22.0	24.0	2.83	72.0	1.43	36.2	150
8GS-8FFORX XBULK	7347-3024	1/2	12.7	13/16-16	27.0	24.0	2.87	73.0	1.40	35.5	200
8GS-10FFORX XBULK	7347-3025	1/2	12.7	1-14	27.0	30.0	3.07	78.0	1.59	40.5	80
8GS-12FFORX XBULK	7347-3026	1/2	12.7	1 3/16-12	27.0	36.0	3.11	79.0	1.63	41.5	100
12GS-10FFORX XBULK	7347-3043	3/4	19.1	1-14	32.0	30.0	3.82	97.0	1.81	46.0	60
12GS-12FFORX XBULK	7347-3044	1	25.4	1 3/16-12	32.0	36.0	1.95	99.0	1.89	48.0	75
12GS-16FFORX XBULK	7347-3046	1	25.4	1 7/16-12	32.0	41.0	4.06	103.0	2.05	52.0	50
16GS-16FFORX XBULK	7347-3055	1	25.4	1 7/16-12	41.0	41.0	4.36	110.8	2.14	54.4	50
16GS-20FFORX XBULK	7347-3056	1	25.4	1 11/16-12	41.0	50.0	4.36	110.7	2.14	54.3	35
20GS-20FFORX XBULK	7347-3064	1 1/4	31.7	1 11/16-12	50.0	50.0	5.04	128.0	2.24	56.9	25

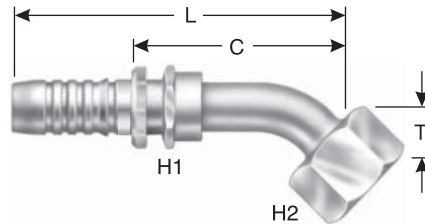
## Female Flat-Face O-Ring Swivel - 22° Bent Tube



Descr.	Prod. No.	⊖			H1	H2	T		L		C		Std. Pack
		"	mm		mm	mm	"	mm	"	mm	"	mm	
<b>STANDARD PACK</b>													
16GS-16FFORX22-011	7347-78615	1	19.1	1 7/16-12	41.0	41.0	.43	11.0	5.87	149.9	3.68	93.5	1

EQUIPMENT
HOSE/CPLG. SELECTION
<b>GLOBALSPIRAL COUPLINGS</b>
PCM/PCS FERRULES
MEGACRIMP COUPLINGS
POWER CRIMP COUPLINGS
LOW PRESSURE COUPLINGS
POLARSEAL COUPLINGS
C14 COUPLINGS
PCTS THERMO-PLASTIC COUPLINGS
FIELD ATTACHABLE G1 & G2 COUPLINGS
FIELD ATTACHABLE C5 COUPLINGS
SURELOK AIR BRAKE COUPLINGS
QUICK DISCONNECT COUPLERS
NEW BALL VALVES
ACCESSORIES
EQUIPMENT AND PARTS





# GlobalSpiral™ Couplings

## Female Flat-Face O-Ring Swivel - 30° Bent Tube

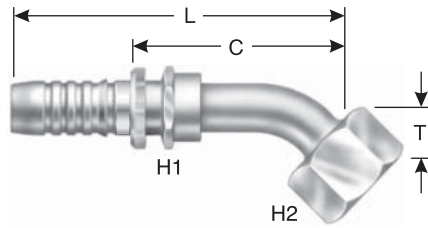

Descr.	Prod. No.	⊖		🌀	H1	H2	T		L		C		Std. Pack
		"	mm		mm	mm	"	mm	"	mm	"	mm	
<b>STANDARD PACK</b>													
16GS-16FFORX30-14	7347-76345	1	19.1	1 7/16-12	41.0	41.0	.55	14.0	5.87	149.0	3.64	92.5	1

## Female Flat-Face O-Ring Swivel - 45° Short Bent Tube

Metric Hex per ISO Draft International Standard 12151-1.

SAE J1453 O-Ring Face Seal.

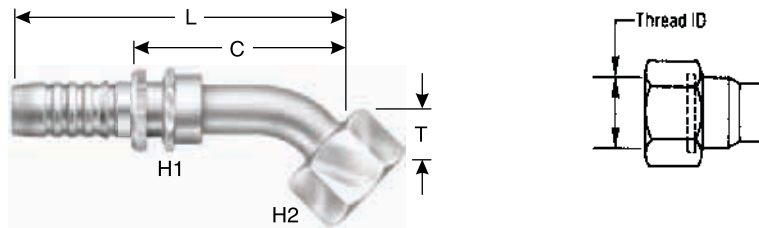

Descr.	Prod. No.	⊖		🌀	H1	H2	T		L		C		Std. Pack
		"	mm		mm	mm	"	mm	"	mm	"	mm	
<b>STANDARD PACK</b>													
6GS-6FFORX45S	7347-31145	3/8	9.5	11/16-16	22.0	22.0	.43	11.0	3.23	82.0	1.82	46.2	1
6GS-8FFORX45S	7347-31155	3/8	9.5	13/16-16	22.0	24.0	.59	15.0	3.66	93.0	2.25	57.2	1
8GS-8FFORX45S	7347-31245	1/2	12.7	13/16-16	27.0	24.0	.59	15.0	3.70	94.0	2.22	56.5	1
8GS-10FFORX45S	7347-31255	1/2	12.7	1-14	27.0	30.0	.63	16.0	3.90	99.0	2.42	61.5	1
8GS-12FFORXMM45S-021	7347-31265	1/2	12.7	1 3/16-12	27.0	36.0	.82	21.0	4.53	115.0	3.05	77.5	1
10GS-10FFORX45S	7347-31345	5/8	15.8	1-14	30.0	30.0	.63	16.0	4.37	111.0	2.39	60.7	1
12GS-12FFORX45S	7347-31445	3/4	19.1	1 3/16-12	32.0	36.0	.83	21.0	4.92	125.0	2.91	74.0	1
12GS-16FFORX45S	7347-31465	3/4	19.1	1 7/16-12	32.0	24.0	.94	24.0	5.39	137.0	3.39	86.0	1
16GS-16FFORX45S	7347-31555	1	25.4	1 7/16-12	41.0	24.0	.94	24.0	5.67	144.0	3.46	87.8	1
16GS-20FFORX45S	7347-31565	1	25.4	1 11/16-12	41.0	50.0	.98	25.0	6.46	164.0	4.24	107.6	1
20GS-20FFORX45-032	7347-76045	1 1/4	31.7	1 11/16-12	50.0	50.0	1.26	32.0	7.09	180.0	4.29	108.9	1
<b>BULK PACK</b>													
8GS-8FFORX45SXBULK	7347-3124	1/2	12.7	13/16-16	27.0	24.0	.59	15.0	3.70	94.0	2.22	56.5	125
12GS-12FFORX45SXBULK	7347-3144	3/4	19.1	1 3/16-12	32.0	36.0	.83	21.0	4.92	125.0	2.91	74.0	60
12GS-16FFORX45SXBULK	7347-3146	3/4	19.1	1 7/16-12	32.0	24.0	.94	24.0	5.39	137.0	3.39	86.0	40
16GS-16FFORX45SXBULK	7347-3155	1	25.4	1 7/16-12	41.0	24.0	.94	24.0	5.67	144.0	3.46	87.8	35
16GS-20FFORX45SXBULK	7347-3156	1	25.4	1 11/16-12	41.0	50.0	.98	25.0	6.46	164.0	4.24	107.6	25
20GS-20FFORX45-032XBULK	7347-7604	1 1/4	31.7	1 11/16-12	50.0	50.0	1.26	32.0	7.09	180.0	4.29	108.9	25





## Female Flat-Face O-Ring Swivel - 90° Short Bent Tube

Metric Hex per ISO Draft International Standard 12151-1.  
SAE J1453 O-Ring Face Seal.

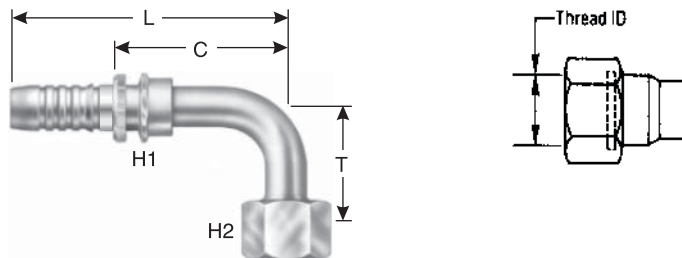

Descr.	Prod. No.	⌀		🌀	H1	H2	T		L		C		Std. Pack
		"	mm		mm	mm	"	mm	"	mm	"	mm	
<b>STANDARD PACK</b>													
6GS-6FFORX90S	7347-32145	3/8	9.5	11/16-16	22.0	22.0	.91	23.0	3.07	78.0	1.66	42.2	1
8GS-8FFORX90S	7347-32245	1/2	12.7	13/16-16	27.0	24.0	1.14	29.0	3.39	86.0	1.91	48.5	1
8GS-12FFORX90S	7347-32265	1/2	12.7	1 3/16-12	27.0	36.0	1.89	48.0	4.21	107.0	2.74	69.5	1
10GS-10FFORX90S	7347-32345	5/8	15.8	1-14	30.0	30.0	1.26	32.0	4.20	106.6	2.22	56.3	1
12GS-10FFORX90S	7347-32435	3/4	19.1	1-14	30.0	30.0	1.26	32.0	4.37	111.0	2.36	60.0	1
12GS-12FFORX90S	7347-32445	3/4	19.1	1 3/16-12	32.0	36.0	1.89	48.0	5.04	128.0	3.03	77.0	1
12GS-16FFORX90S	7347-32465	3/4	19.1	1 7/16-12	32.0	41.0	2.20	56.0	5.39	137.0	3.39	86.0	1
16GS-16FFORX90S	7347-32555	1	25.4	1 7/16-12	41.0	41.0	2.20	56.0	5.67	144.0	3.45	87.6	1
16GS-20FFORX90S	7347-32565	1	25.4	1 11/16-12	41.0	50.0	2.52	64.0	6.06	154.0	3.84	97.6	1
20GS-20FFORX90S	7347-32645	1 1/4	31.7	1 11/16-12	50.0	50.0	2.52	64.0	6.77	172.0	3.97	100.9	1
20GS-24FFORX90-064	7347-76985	1 1/4	31.7	2-12	50.0	60.0	2.52	64.0	6.77	172.0	3.97	100.9	1
<b>BULK PACK</b>													
8GS-8FFORX90SXBULK	7347-3224	1/2	12.7	13/16-16	27.0	24.0	1.14	29.0	3.39	86.0	1.91	48.5	140
12GS-12FFORX90SXBULK	7347-3244	3/4	19.1	1 3/16-12	32.0	36.0	1.89	48.0	5.04	128.0	3.03	77.0	50
12GS-16FFORX90SXBULK	7347-3246	3/4	19.1	1 7/16-12	32.0	41.0	2.20	56.0	5.39	137.0	3.39	86.0	35
16GS-16FFORX90SXBULK	7347-3255	1	25.4	1 7/16-12	41.0	41.0	2.20	56.0	5.67	144.0	3.45	87.6	25
20GS-20FFORX90SXBULK	7347-3264	1 1/4	31.7	1 11/16-12	50.0	50.0	2.52	64.0	6.77	172.0	3.97	100.9	20

## Female Flat-Face O-Ring Swivel - 90° Medium Bent Tube

Metric Hex per ISO Draft International Standard 12151-1.  
SAE J1453 O-Ring Face Seal.

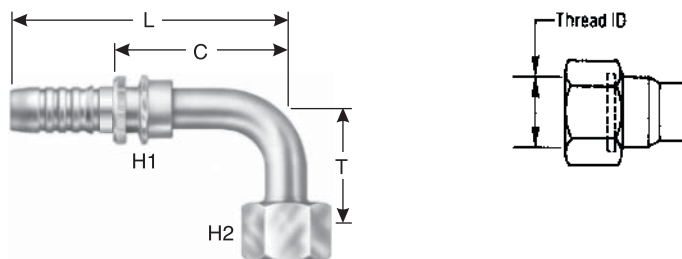

Descr.	Prod. No.	⌀		🌀	H1	H2	T		L		C		Std. Pack
		"	mm		mm	mm	"	mm	"	mm	"	mm	
<b>STANDARD PACK</b>													
6GS-8FFORX90M	7347-33155	3/8	9.5	13/16-16	22.0	24.0	1.61	41.0	3.35	85.0	1.94	49.2	1
8GS-8FFORX90M	7347-33245	5/8	15.8	1-14	27.0	24.0	1.61	41.0	3.39	86.0	1.91	48.5	1
8GS-10FFORX90M	7347-33255	1/2	12.7	1-14	27.0	30.0	1.85	47.0	3.98	101.0	2.50	63.5	1

EQUIPMENT
HOSE/CPLG. SELECTION
<b>GLOBALSPIRAL COUPLINGS</b>
PCM/PCS FERRULES
MEGACRIMP COUPLINGS
POWER CRIMP COUPLINGS
LOW PRESSURE COUPLINGS
POLARSEAL COUPLINGS
C14 COUPLINGS
PCTS THERMO-PLASTIC COUPLINGS
FIELD ATTACHABLE G1 & G2 COUPLINGS
FIELD ATTACHABLE C5 COUPLINGS
SURELOK AIR BRAKE COUPLINGS
QUICK DISCONNECT COUPLERS
NEW BALL VALVES
ACCESSORIES
EQUIPMENT AND PARTS





# GlobalSpiral™ Couplings

EQUIPMENT

HOSE/CPLG. SELECTION

GLOBALSPIRAL COUPLINGS

PCM/PCS FERRULES

MEGACRIMP COUPLINGS

POWER CRIMP COUPLINGS

LOW PRESSURE COUPLINGS

POLARSEAL COUPLINGS

C14 COUPLINGS

PCTS THERMO-PLASTIC COUPLINGS

FIELD ATTACHABLE G1 & G2 COUPLINGS

FIELD ATTACHABLE C5 COUPLINGS

SURELOK AIR BRAKE COUPLINGS

QUICK DISCONNECT COUPLERS

NEW BALL VALVES

ACCESSORIES

EQUIPMENT AND PARTS

## Female Flat-Face O-Ring Swivel - 90° Medium Bent Tube - Cont'd

Descr.	Prod. No.	⊖			H1	H2	T		L		C		Std. Pack
		"	mm		mm	mm	"	mm	"	mm	"	mm	
10GS-10FFORX90M	7347-33345	5/8	15.8	1-14	30.0	30.0	1.85	47.0	4.21	107.0	2.20	56.0	1
12GS-12FFORX90M	7347-33445	3/4	19.1	1 3/16-12	32.0	36.0	2.28	58.0	5.04	128.0	3.03	77.0	1
12GS-16FFORX90M	7347-33465	3/4	19.1	1 7/16-12	32.0	41.0	2.80	71.0	5.39	137.0	3.39	86.0	1
16GS-16FFORX90M	7347-33555	1	25.4	1 7/16-12	41.0	41.0	2.80	71.0	5.67	144.0	3.45	87.6	1
16GS-20FFORX90M	7347-33565	1	25.4	1 11/16-12	41.0	50.0	3.07	78.0	6.05	153.6	3.83	97.2	1
20GS-20FFORX90M	7347-33645	1 1/4	31.7	1 11/16-12	50.0	50.0	3.07	78.0	6.77	172.0	3.97	100.9	1
<b>BULK PACK</b>													
12GS-12FFORX90MXBULK	7347-33444	3/4	19.1	1 3/16-12	32.0	36.0	2.28	58.0	5.04	128.0	3.03	77.0	40
16GS-16FFORX90MXBULK	7347-33555	1	25.4	1 7/16-12	41.0	41.0	2.80	71.0	5.67	144.0	3.45	87.6	30

## Female Flat-Face O-Ring Swivel - 90° Long Bent Tube

Metric Hex per ISO Draft International Standard 12151-1.  
SAE J1453 O-Ring Face Seal.

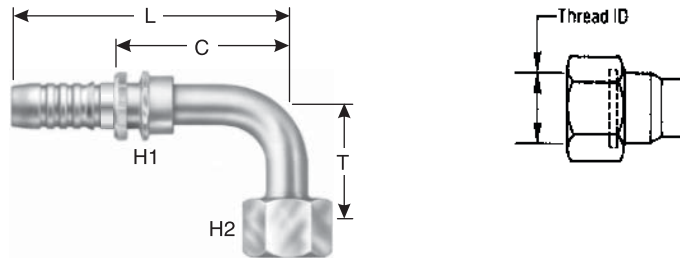

Descr.	Prod. No.	⊖			H1	H2	T		L		C		Std. Pack
		"	mm		mm	mm	"	mm	"	mm	"	mm	
<b>STANDARD PACK</b>													
6GS-6FFORX90L	7347-34145	3/8	9.5	11/16-16	22.0	22.0	2.13	54.0	3.35	85.0	1.94	49.2	1
8GS-8FFORX90-083	7347-73845	1/2	12.7	13/16-16	27.0	24.0	3.27	83.0	3.39	86.0	1.91	48.5	1
8GS-10FFORX90L	7347-34255	1/2	12.7	1-14	27.0	30.0	2.76	70.0	3.98	101.0	2.50	63.5	1
10GS-10FFORX90L	7347-34345	5/8	15.8	1-14	30.0	30.0	2.76	70.0	4.45	113.0	2.44	62.0	1
12GS-12FFORX90L	7347-34445	3/4	19.1	1 3/16-12	32.0	36.0	3.78	96.0	5.04	128.0	3.03	77.0	1
12GS-16FFORX90L	7347-34465	3/4	19.1	1 7/16-12	32.0	41.0	4.49	114.0	5.39	137.0	3.39	86.0	1
16GS-16FFORX90L	7347-34555	1	25.4	1 7/16-12	41.0	41.0	4.49	114.0	5.67	144.0	3.45	87.6	1
16GS-20FFORX90L	7347-34565	1	25.4	1 11/16-12	41.0	50.0	5.08	129.0	6.05	153.6	3.83	97.2	1
20GS-20FFORX90L	7347-34645	1 1/4	31.7	1 11/16-12	50.0	50.0	5.08	129.0	6.77	172.0	3.97	100.9	1
<b>BULK PACK</b>													
12GS-12FFORX90LXBULK	7347-34444	3/4	19.1	1 3/16-12	32.0	36.0	3.78	96.0	5.04	128.0	3.03	77.0	25
12GS-16FFORX90LXBULK	7347-34466	3/4	19.1	1 7/16-12	32.0	41.0	4.49	114.0	5.39	137.0	3.39	86.0	30
16GS-16FFORX90LXBULK	7347-34555	1	25.4	1 7/16-12	41.0	41.0	4.49	114.0	5.67	144.0	3.45	87.6	20





## Female Flat-Face O-Ring Swivel - 135° Bent Tube

Metric Hex per ISO Draft International Standard 12151-1.  
SAE J1453 O-Ring Face Seal.

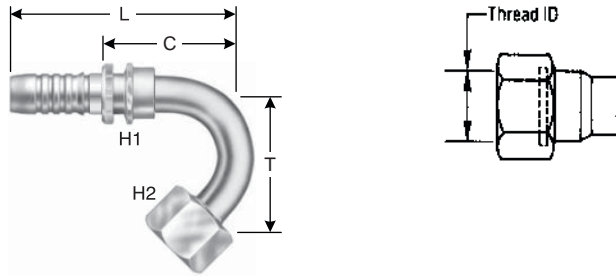

Descr.	Prod. No.	⌀			H1	H2	T		L		C		Std. Pack
		"	mm		mm	mm	"	mm	"	mm	"	mm	
<b>STANDARD PACK</b>													
12GS-16FFORX135	7347-73795	3/4	19.1	1 7/16-12	27.0	24.0	3.28	83.0	3.39	86.0	1.48	37.5	1

## Code 61 O-Ring Flange

See Accessories for O-Rings.

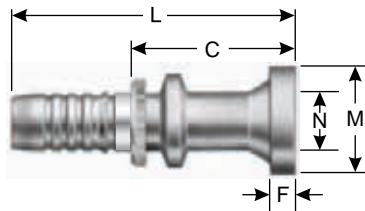

Descr.	Prod. No.	⌀		N	M	L		C		F		Std. Pack	
		"	mm			"	mm	"	mm	"	mm		
<b>STANDARD PACK</b>													
6GS-8FL	7347-41155	3/8	9.5	1/2	1.19	30.2	3.54	90.0	2.13	54.2	.27	6.7	1
8GS-8FL	7347-41245	1/2	12.7	1/2	1.19	30.2	3.66	93.0	2.19	55.5	.27	6.7	1
8GS-12FL	7347-41265	1/2	12.7	3/4	1.50	38.1	3.86	98.0	2.38	60.5	.27	6.7	1
8GS-16FL	7347-41285	1/2	12.7	1	1.75	44.5	2.84	72.2	1.37	34.7	.32	8.0	1
10GS-12FL	7347-41355	5/8	15.8	3/4	1.50	38.1	4.29	109.0	2.31	58.7	.27	6.7	1
12GS-8FL	7347-41425	3/4	19.1	1/2	1.19	30.2	4.41	112.0	2.40	61.0	.27	6.7	1
12GS-12FL	7347-41445	3/4	19.1	3/4	1.50	38.1	4.37	111.0	2.36	60.0	.27	6.7	1
12GS-16FL*	7347-41465	3/4	19.1	1	1.75	44.5	4.37	111.0	2.36	60.0	.32	8.0	1
12GS-20FL*	7347-41475	3/4	19.1	1 1/4	2.00	50.8	4.37	111.0	2.36	60.0	.32	8.0	1
16GS-12FL	7347-41535	1	25.4	3/4	1.50	38.1	4.65	118.0	2.40	61.0	.27	6.7	1
16GS-16FL*	7347-41555	1	25.4	1	1.75	44.5	4.92	125.0	2.70	68.6	.32	8.0	1
16GS-20FL*	7347-41565	1	25.4	1 1/4	2.00	50.8	4.92	125.0	2.69	68.2	.32	8.0	1
16GS-24FL*	7347-41575	1	25.4	1 1/2	2.38	60.5	4.92	125.0	1.90	48.2	.32	8.0	1
20GS-16FL*	7347-41635	1 1/4	31.7	1	1.75	44.5	5.35	136.0	2.55	64.9	.32	8.0	1
20GS-20FL*	7347-41645	1 1/4	31.7	1 1/4	2.00	50.8	5.75	146.0	2.95	74.9	.32	8.0	1
20GS-24FL*	7347-41655	1 1/4	31.7	1 1/2	2.38	60.5	6.30	160.0	3.50	88.9	.32	8.0	1
20GS-32FL*	7347-41665	1 1/4	31.7	2	2.81	71.4	5.71	145.0	2.91	73.9	.38	9.5	1
24GSP-24FL	7347-41725	1 1/2	38.1	1 1/2	2.38	60.3	6.02	152.9	3.12	79.3	.32	8.0	1
32GSP-32FL	7347-41795	2	50.8	2	2.81	71.4	6.27	159.3	2.65	67.3	.38	9.5	1
<b>BULK PACK</b>													
8GS-8FLXBULK	7347-4124	1/2	12.7	1/2	1.19	30.2	3.66	93.0	2.19	55.5	.27	6.7	100

EQUIPMENT

HOSE/CPLG. SELECTION

GLOBALSPIRAL COUPLINGS

PCM/PCS FERRULES

MEGACRIMP COUPLINGS

POWER CRIMP COUPLINGS

LOW PRESSURE COUPLINGS

POLARSEAL COUPLINGS

C14 COUPLINGS

PCTS THERMO-PLASTIC COUPLINGS

FIELD ATTACHABLE G1 & G2 COUPLINGS

FIELD ATTACHABLE C5 COUPLINGS

SURELOK AIR BRAKE COUPLINGS

QUICK DISCONNECT COUPLERS

NEW BALL VALVES

ACCESSORIES

EQUIPMENT AND PARTS



# GlobalSpiral™ Couplings



EQUIPMENT
HOSE/CPLG. SELECTION
GLOBALSPIRAL COUPLINGS
PCM/PCS FERRULES
MEGACRIMP COUPLINGS
POWER CRIMP COUPLINGS
LOW PRESSURE COUPLINGS
POLARSEAL COUPLINGS
C14 COUPLINGS
PCTS THERMO-PLASTIC COUPLINGS
FIELD ATTACHABLE G1 & G2 COUPLINGS
FIELD ATTACHABLE C5 COUPLINGS
SURELOK AIR BRAKE COUPLINGS
QUICK DISCONNECT COUPLERS
NEW BALL VALVES
ACCESSORIES
EQUIPMENT AND PARTS

## Code 61 O-Ring Flange - Cont'd

Descr.	Prod. No.	⊖		N		M		L		C		F		Std. Pack
		"	mm	"	"	mm	"	mm	"	mm	"	mm		
8GS-12FLXBULK	7347-4126	1/2	12.7	3/4	1.19	38.2	3.66	98.0	2.38	60.5	.27	6.7	60	
12GS-12FLXBULK	7347-4144	3/4	19.1	3/4	1.50	38.1	4.37	111.0	2.36	60.0	.27	6.7	70	
12GS-16FLXBULK	7347-4146	3/4	19.1	1	1.75	44.5	4.37	111.0	2.36	60.0	.32	8.0	50	
16GS-16FLXBULK	7347-4155	1	25.4	1	1.75	44.5	4.92	125.0	2.70	68.6	.32	8.0	45	
16GS-20FLXBULK	7347-4156	1	25.4	1 1/4	2.00	50.8	4.92	125.0	2.69	68.2	.32	8.0	35	
20GS-20FLXBULK	7347-4164	1 1/4	31.7	1 1/4	2.00	50.8	5.75	146.0	2.95	74.9	.32	8.0	25	
20GS-24FLXBULK	7347-4165	1 1/4	31.7	1 1/2	2.38	60.5	6.30	160.0	3.50	88.9	.32	8.0	25	
24GSP-24FL XBULK	7347-4172	1 1/2	38.1	1 1/2	2.38	60.3	6.02	152.9	3.12	79.3	.32	8.0	20	
32GSP-32FL XBULK	7347-4179	2	50.8	2	2.81	71.4	6.27	159.3	2.65	67.3	.38	9.5	15	

\* -16FL Max. W.P. 5,000 psi; -20FL Max. W.P. 4,000 psi; -24FL Max. W.P. 3,000 psi; -32FL Max. W.P. 2,000 psi.

## Code 61 O-Ring Flange Long Neck

S, M and L Drops per ISO Final Draft International Standard 12151-3.  
See Accessories for O-Rings.

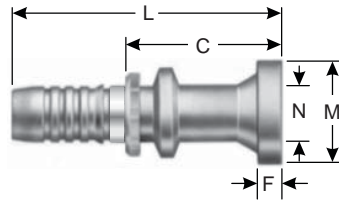

Descr.	Prod. No.	⊖		N		M		L		C		F		Std. Pack
		"	mm	"	"	mm	"	mm	"	mm	"	mm		
<b>STANDARD PACK</b>														
12GS-12FLL	7347-41455	3/4	19.1	3/4	1.50	38.1	5.20	132.0	3.19	81.0	.27	6.7	1	
16GS-16FLL*	7347-41545	1	25.4	1	1.75	44.5	5.63	143.0	3.41	86.6	.32	8.0	1	
20GS-20FLL*	7347-41675	1 1/4	31.7	1 1/4	2.00	50.8	6.26	159.0	3.46	87.9	.32	8.0	1	

\* -16FL Max. W.P. 5,000 psi; -20FL Max. W.P. 4,000 psi; -24FL Max. W.P. 3,000 psi; -32FL Max. W.P. 2,000 psi.

## Code 61 O-Ring Flange - 22½° Bent Tube

S, M and L Drops per ISO Final Draft International Standard 12151-3.  
See Accessories for O-Rings.

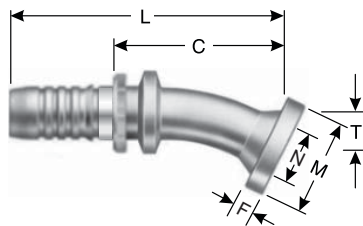

Descr.	Prod. No.	⊖		N		M		T		L		C		F		Std. Pack
		"	mm	"	"	mm	"	mm	"	mm	"	mm	"	mm		
<b>STANDARD PACK</b>																
8GS-8FL22M	7347-42245	1/2	12.7	1/2	1.19	30.2	.35	9.0	3.78	96.0	2.30	58.5	.27	6.7	1	
12GS-12FL22M	7347-42445	3/4	19.1	3/4	1.50	38.1	.43	11.0	5.16	131.0	3.15	80.0	.27	6.7	1	
12GS-16FL22M*	7347-42465	3/4	19.1	1	1.75	44.5	.55	14.0	5.24	133.0	3.23	82.0	.32	8.0	1	





## Code 61 O-Ring Flange - 22½° Bent Tube - Cont'd

Descr.	Prod. No.	⊖		N	M		T		L		C		F		Std. Pack
		"	mm		"	"	mm	"	mm	"	mm	"	mm	"	
16GS-16FL22M*	7347-42555	1	25.4	1	1.75	44.5	.55	14.0	6.10	155.0	3.87	98.4	.32	8.0	1
16GS-20FL22M*	7347-42565	1	25.4	1 1/4	2.00	50.8	.59	15.0	6.61	168.0	4.37	111.0	.32	8.0	1
20GS-20FL22M*	7347-42645	1 1/4	31.7	1 1/4	2.00	50.8	.59	15.0	7.01	178.0	4.21	106.9	.32	8.0	1
20GS-24FL22M*	7347-42655	1 1/4	31.7	1 1/2	2.38	60.5	.71	18.0	7.32	186.0	4.52	114.9	.32	8.0	1
<b>BULK PACK</b>															
12GS-12FL22MXBULK	7347-4244	3/4	19.1	3/4	1.50	38.1	.43	11.0	5.16	131.0	3.15	80.0	.27	6.7	50
16GS-16FL22MXBULK	7347-4255	1	25.4	1	1.75	44.5	.55	14.0	6.10	155.0	3.87	98.4	.32	8.0	30

\* -16FL Max. W.P. 5,000 psi; -20FL Max. W.P. 4,000 psi; -24FL Max. W.P. 3,000 psi; -32FL Max. W.P. 2,000 psi.

## Code 61 O-Ring Flange - 30° Bent Tube

S, M and L Drops per ISO Final Draft International Standard 12151-3.  
See Accessories for O-Rings.

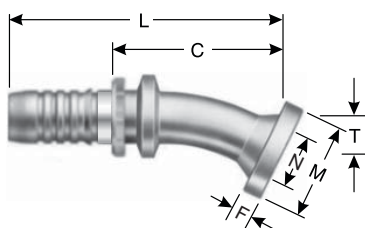

Descr.	Prod. No.	⊖		N	M		T		L		C		F		Std. Pack
		"	mm		"	"	mm	"	mm	"	mm	"	mm	"	
<b>STANDARD PACK</b>															
8GS-12FL30M	7347-43265	1/2	12.7	3/4	1.50	38.1	.63	16.0	3.94	100.0	2.46	62.5	.27	6.7	1
12GS-12FL30M	7347-43445	3/4	19.1	3/4	1.50	38.1	.63	16.0	5.08	129.0	3.07	78.0	.27	6.7	1
12GS-16FL30M*	7347-43465	3/4	19.1	1	1.75	44.5	.75	19.0	4.76	121.0	2.76	70.0	.32	8.0	1
16GS-16FL30M*	7347-43555	1	25.4	1	1.75	44.5	.75	19.0	6.02	153.0	3.80	96.6	.32	8.0	1
16GS-20FL30M*	7347-43565	1	25.4	1 1/4	2.00	50.8	.87	22.0	6.54	166.0	4.29	109.0	.32	8.0	1
20GS-20FL30M*	7347-43645	1 1/4	31.7	1 1/4	2.00	50.8	.87	22.0	6.93	176.0	4.13	104.9	.32	8.0	1
20GS-24FL30M*	7347-43655	1 1/4	31.7	1 1/2	2.38	60.5	1.18	30.0	7.17	182.0	4.37	110.9	.32	8.0	1
<b>BULK PACK</b>															
8GS-12FL30MXBULK	7347-4326	1/2	12.7	3/4	1.50	38.1	.63	16.0	3.94	100.0	2.46	62.5	.27	6.7	125
16GS-16FL30MXBULK	7347-4355	1	25.4	1	1.75	44.5	.75	19.0	6.02	153.0	3.80	96.6	.32	8.0	30
20GS-20FL30MXBULK	7347-4364	1 1/4	31.7	1 1/4	2.00	50.8	.87	22.0	6.93	176.0	4.13	104.9	.32	8.0	20

\* -16FL Max. W.P. 5,000 psi; -20FL Max. W.P. 4,000 psi; -24FL Max. W.P. 3,000 psi; -32FL Max. W.P. 2,000 psi.

EQUIPMENT
HOSE/CPLG. SELECTION
GLOBALSPIRAL COUPLINGS
PCM/PCS FERRULES
MEGACRIMP COUPLINGS
POWER CRIMP COUPLINGS
LOW PRESSURE COUPLINGS
POLARSEAL COUPLINGS
C14 COUPLINGS
PCTS THERMO-PLASTIC COUPLINGS
FIELD ATTACHABLE G1 & G2 COUPLINGS
FIELD ATTACHABLE C5 COUPLINGS
SURELOK AIR BRAKE COUPLINGS
QUICK DISCONNECT COUPLERS
NEW BALL VALVES
ACCESSORIES
EQUIPMENT AND PARTS





# GlobalSpiral™ Couplings

## Code 61 O-Ring Flange - 45° Short Bent Tube

S, M and L Drops per ISO Final Draft International Standard 12151-3.  
See Accessories for O-Rings.

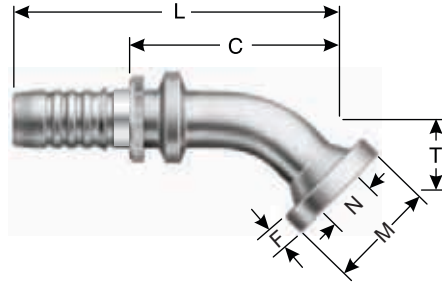

Descr.	Prod. No.	⊖		N	M		T		L		C		F		Std. Pack
		"	mm		"	"	mm	"	mm	"	mm	"	mm	"	
<b>STANDARD PACK</b>															
12GS-16FL45S*	7347-73135	3/4	19.1	1	1.75	44.5	1.10	28.0	4.96	126.0	2.95	75.0	.32	8.0	1
20GS-20FL45S*	7347-73565	1 1/4	31.7	1 1/4	2.00	50.8	1.26	32.0	6.69	170.0	3.89	98.9	.32	8.0	1
20GS-24FL45S*	7347-73575	1 1/4	31.7	1 1/2	2.38	60.5	1.50	38.0	6.93	176.0	4.13	104.8	.32	8.0	1
24GSP-20FL45S	7347-44715	1 1/2	38.1	1 1/4	2.00	50.8	1.26	32.0	7.09	180.0	4.49	114.5	.32	8.0	1
24GSP-24FL45S	7347-44725	1 1/2	38.1	1 1/2	2.38	60.3	1.50	38.0	7.95	202.0	5.05	128.6	.32	8.0	1
32GSP-32FL45-066	7347-44805	2	50.8	2	2.81	71.4	2.60	66.0	10.12	257.0	6.50	165.0	.38	9.5	1
<b>BULK PACK</b>															
12GS-16FL45SXBULK	7347-7313	3/4	19.1	1	1.75	44.5	1.10	28.0	4.96	126.0	2.95	75.0	.32	8.0	50
20GS-20FL45SXBULK	7347-7356	1 1/4	31.7	1 1/4	2.00	50.8	1.26	32.0	6.69	170.0	3.89	98.9	.32	8.0	20
24GSP-24FL45S XBULK	7347-4472	1 1/2	38.1	1 1/2	2.38	60.3	1.50	38.0	7.95	202.0	5.05	128.6	.32	8.0	20
32GSP-32FL45-066XBULK	7347-4480	2	50.8	2	2.81	71.4	2.60	66.0	10.12	257.0	6.50	165.0	.38	9.5	5

\* -16FL Max. W.P. 5,000 psi; -20FL Max. W.P. 4,000 psi; -24FL Max. W.P. 3,000 psi; -32FL Max. W.P. 2,000 psi.

## Code 61 O-Ring Flange - 45° Medium Bent Tube

S, M and L Drops per ISO Final Draft International Standard 12151-3.  
See Accessories for O-Rings.

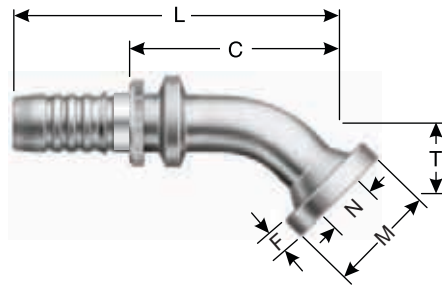

Descr.	Prod. No.	⊖		N	M		T		L		C		F		Std. Pack
		"	mm		"	"	mm	"	mm	"	mm	"	mm	"	
<b>STANDARD PACK</b>															
6GS-8FL45M	7347-44155	3/8	9.5	1/2	1.19	30.2	.75	19.0	3.66	93.0	2.25	57.2	.27	6.7	1
8GS-8FL45M	7347-44245	1/2	12.7	1/2	1.19	30.2	.75	19.0	3.70	94.0	2.22	56.5	.27	6.7	1
8GS-12FL45M	7347-44265	1/2	12.7	3/4	1.50	38.1	1.02	26.0	3.98	101.0	2.50	63.5	.27	6.7	1
10GS-12FL45M	7347-44355	5/8	15.8	3/4	1.50	38.1	1.02	26.0	5.00	127.0	3.02	76.7	.27	6.7	1
12GS-12FL45M	7347-44445	3/4	19.1	3/4	1.50	38.1	1.02	26.0	4.88	124.0	2.87	73.0	.27	6.7	1
16GS-16FL45M*	7347-44555	1	25.4	1	1.75	44.5	1.26	32.0	5.79	147.0	3.57	90.6	.32	8.0	1





## Code 61 O-Ring Flange - 45° Medium Bent Tube - Cont'd

Descr.	Prod. No.	⊖		N	M		T		L		C		F		Std. Pack
		"	mm		"	"	mm	"	mm	"	mm	"	mm	"	
16GS-20FL45M*	7347-44565	1	25.4	1 1/4	2.00	50.8	1.50	38.0	6.22	158.0	3.97	100.8	.32	8.0	1
20GS-16FL45M*	7347-44635	1 1/4	31.7	1	1.75	44.5	1.26	32.0	6.42	163.0	3.62	91.9	.32	8.0	1
<b>BULK PACK</b>															
8GS-8FL45MXBULK	7347-4424	1/2	12.7	1/2	1.19	30.2	.75	19.0	3.70	94.0	2.22	56.5	.27	6.7	125
8GS-12FL45MXBULK	7347-4426	1/2	12.7	3/4	1.50	38.1	1.02	26.0	3.98	101.0	2.50	63.5	.27	6.7	75
12GS-12FL45MXBULK	7347-4444	3/4	19.1	3/4	1.50	38.1	1.02	26.0	4.88	124.0	2.87	73.0	.27	6.7	75
16GS-16FL45MXBULK	7347-4455	1	25.4	1	1.75	44.5	1.26	32.0	5.79	147.0	3.57	90.6	.32	8.0	40
16GS-20FL45MXBULK	7347-4456	1	25.4	1 1/4	2.00	50.8	1.50	38.0	6.22	158.0	3.97	100.8	.32	8.0	25

\* -16FL Max. W.P. 5,000 psi; -20FL Max. W.P. 4,000 psi; -24FL Max. W.P. 3,000 psi; -32FL Max. W.P. 2,000 psi.

## Code 61 O-Ring Flange - 60° Bent Tube

S, M and L Drops per ISO Final Draft International Standard 12151-3.  
See Accessories for O-Rings.

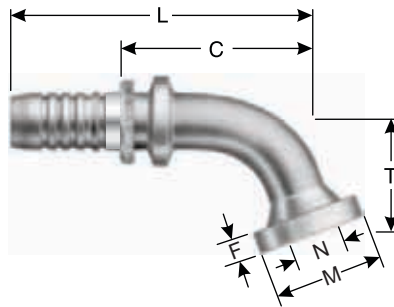

Descr.	Prod. No.	⊖		N	M		T		L		C		F		Std. Pack
		"	mm		"	"	mm	"	mm	"	mm	"	mm	"	
<b>STANDARD PACK</b>															
8GS-8FL60M	7347-45245	1/2	12.7	1/2	1.19	30.2	1.06	27.0	4.09	104.0	2.62	66.5	.27	6.7	1
12GS-12FL60M	7347-45445	3/4	19.1	3/4	1.50	38.1	1.46	37.0	5.39	137.0	3.39	86.0	.27	6.7	1
12GS-16FL60M*	7347-45465	3/4	19.1	1	1.75	44.5	1.73	44.0	5.35	136.0	3.35	85.0	.32	8.0	1
16GS-16FL60M*	7347-45555	1	25.4	1	1.75	44.5	1.73	44.0	6.18	157.0	3.97	100.8	.32	8.0	1
16GS-20FL60M*	7347-45565	1	25.4	1 1/4	2.00	50.8	2.17	55.0	6.18	157.0	3.94	100.2	.32	8.0	1
20GS-20FL60M*	7347-45645	1 1/4	31.7	1 1/4	2.00	50.8	2.17	55.0	7.36	187.0	4.56	115.9	.32	8.0	1
20GS-24FL60M*	7347-45655	1 1/4	31.7	1 1/2	2.38	60.5	2.52	64.0	7.68	195.0	4.88	123.9	.32	8.0	1
<b>BULK PACK</b>															
16GS-16FL60MXBULK	7347-4555	1	25.4	1	1.75	44.5	1.73	44.0	6.18	157.0	3.97	100.8	.32	8.0	25

\* -16FL Max. W.P. 5,000 psi; -20FL Max. W.P. 4,000 psi; -24FL Max. W.P. 3,000 psi; -32FL Max. W.P. 2,000 psi.

EQUIPMENT
HOSE/CPLG. SELECTION
<b>GLOBALSPIRAL COUPLINGS</b>
PCM/PCS FERRULES
MEGACRIMP COUPLINGS
POWER CRIMP COUPLINGS
LOW PRESSURE COUPLINGS
POLARSEAL COUPLINGS
C14 COUPLINGS
PCTS THERMO-PLASTIC COUPLINGS
FIELD ATTACHABLE G1 & G2 COUPLINGS
FIELD ATTACHABLE C5 COUPLINGS
SURELOK AIR BRAKE COUPLINGS
QUICK DISCONNECT COUPLERS
NEW BALL VALVES
ACCESSORIES
EQUIPMENT AND PARTS



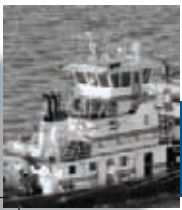

# GlobalSpiral™ Couplings

EQUIPMENT

HOSE/CPLG. SELECTION

GLOBALSPIRAL COUPLINGS

PCM/PCS FERRULES

MEGACRIMP COUPLINGS

POWER CRIMP COUPLINGS

LOW PRESSURE COUPLINGS

POLARSEAL COUPLINGS

C14 COUPLINGS

PCTS THERMO-PLASTIC COUPLINGS

FIELD ATTACHABLE G1 & G2 COUPLINGS

FIELD ATTACHABLE C5 COUPLINGS

SURELOK AIR BRAKE COUPLINGS

QUICK DISCONNECT COUPLERS

NEW BALL VALVES

ACCESSORIES

EQUIPMENT AND PARTS

## Code 61 O-Ring Flange - 67½° Bent Tube

S, M and L Drops per ISO Final Draft International Standard 12151-3.  
See Accessories for O-Rings.

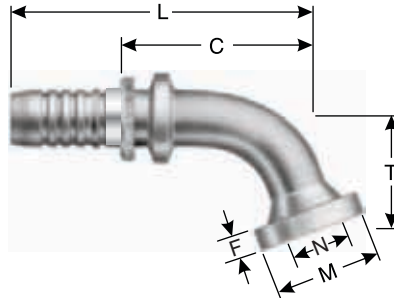

Descr.	Prod. No.	⊖		N		M		T		L		C		F		Std. Pack
		"	mm	"	mm	"	mm	"	mm	"	mm	"	mm	"	mm	
<b>STANDARD PACK</b>																
8GS-12FL67-032	7347-78025	1/2	12.7	1/2	1.50	38.1	1.26	32.0	3.70	94.0	2.21	56.2	.27	6.7	1	
12GS-12FL67M	7347-46445	3/4	19.1	3/4	1.50	38.1	1.65	42.0	5.20	132.0	3.19	81.0	.27	6.7	1	
12GS-16FL67M*	7347-46465	3/4	19.1	1	1.75	44.5	2.01	51.0	5.08	129.0	3.07	78.0	.32	8.0	1	
16GS-16FL67M*	7347-46555	1	25.4	1	1.75	44.5	2.01	51.0	5.94	151.0	3.71	94.3	.32	8.0	1	
16GS-20FL67M*	7347-46565	1	25.4	1 1/4	2.00	50.8	2.52	64.0	5.83	148.0	3.59	91.2	.32	8.0	1	
20GS-20FL67M*	7347-46645	1 1/4	31.7	1 1/4	2.00	50.8	2.52	64.0	7.01	178.0	4.21	106.9	.32	8.0	1	
20GS-24FL67S*	7347-76605	1 1/4	31.7	1 1/2	2.38	60.5	2.01	51.0	6.46	164.0	3.66	92.9	.32	8.0	1	

\* -16FL Max. W.P. 5,000 psi; -20FL Max. W.P. 4,000 psi; -24FL Max. W.P. 3,000 psi; -32FL Max. W.P. 2,000 psi.

## Code 61 O-Ring Flange - 90° Extra Short Bent Tube

S, M and L Drops per ISO Final Draft International Standard 12151-3.  
See Accessories for O-Rings.

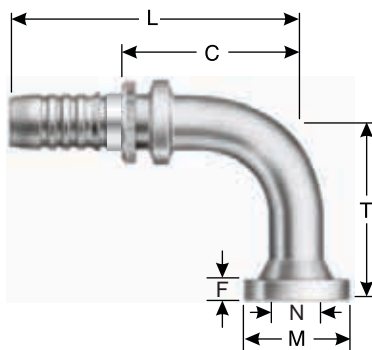

Descr.	Prod. No.	⊖		N		M		T		L		C		F		Std. Pack
		"	mm	"	mm	"	mm	"	mm	"	mm	"	mm	"	mm	
<b>STANDARD PACK</b>																
16GS-24FL90-060*	7347-73975	1	25.4	1 1/2	2.38	60.3	2.36	60.0	5.71	145.0	3.47	88.2	.32	8.0	1	

\* -16FL Max. W.P. 5,000 psi; -20FL Max. W.P. 4,000 psi; -24FL Max. W.P. 3,000 psi; -32FL Max. W.P. 2,000 psi.





## Code 61 O-Ring Flange - 90° Short Bent Tube

S, M and L Drops per ISO Final Draft International Standard 12151-3.  
See Accessories for O-Rings.

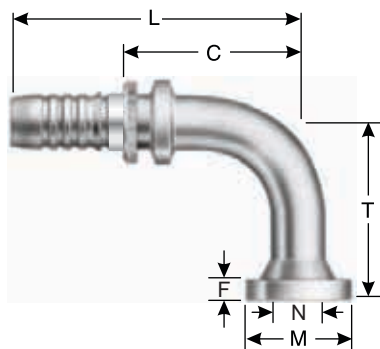

Descr.	Prod. No.	⊖		N	M		T		L		C		F		Std. Pack
		"	mm		"	"	mm	"	mm	"	mm	"	mm	"	
<b>STANDARD PACK</b>															
12GS-8FL90-050	7347-76035	3/4	19.1	1/2	1.19	30.2	1.97	50.0	4.80	122.0	2.80	71.0	.27	6.7	1
12GS-16FL90S*	7347-73915	3/4	19.1	1	1.75	44.5	2.40	61.0	4.41	112.0	2.40	61.0	.32	8.0	1
12GS-20FL90-054*	7347-73995	3/4	19.1	1 1/4	2.00	50.8	2.13	54.0	5.16	131.0	3.15	80.0	.32	8.0	1
16GS-16FL90S*	7347-47555	1	25.4	1	1.75	44.5	2.40	61.0	5.31	135.0	3.09	78.6	.32	8.0	1
16GS-20FL90S*	7347-47565	1	25.4	1 1/4	2.00	50.8	2.68	68.0	5.28	134.0	3.02	76.8	.32	8.0	1
16GS-24FL90S*	7347-47575	1	25.4	1 1/2	2.38	60.5	3.19	81.0	5.28	134.0	3.04	77.2	.32	8.0	1
20GS-20FL90S*	7347-47645	1 1/4	31.7	1 1/4	2.00	50.8	2.68	68.0	6.50	165.0	3.70	93.9	.32	8.0	1
20GS-24FL90S*	7347-47655	1 1/4	31.7	1 1/2	2.38	60.5	3.19	81.0	6.50	165.0	3.70	93.9	.32	8.0	1
24GSP-20FL90S	7347-47715	1 1/2	38.1	1 1/2	2.00	50.8	2.68	68.0	6.81	173.0	3.92	99.6	.32	8.0	1
24GSP-24FL90S	7347-47725	1 1/2	38.1	1 1/2	2.38	60.3	3.19	81.0	7.24	184.0	4.33	109.9	.32	8.0	1
<b>BULK PACK</b>															
12GS-16FL90SXBULK	7347-7391	3/4	19.1	1	1.75	44.5	2.40	61.0	4.41	112.0	2.40	61.0	.32	8.0	45
16GS-16FL90SXBULK	7347-4755	1	25.4	1	1.75	44.5	2.40	61.0	5.31	135.0	3.09	78.6	.32	8.0	25
16GS-20FL90SXBULK	7347-4756	1	25.4	1 1/4	2.00	50.8	2.68	68.0	5.28	134.0	3.02	76.8	.32	8.0	35
20GS-20FL90SXBULK	7347-4764	1 1/4	31.7	1 1/4	2.00	50.8	2.68	68.0	6.50	165.0	3.70	93.9	.32	8.0	20
20GS-24FL90SXBULK	7347-4765	1 1/4	31.7	1 1/2	2.38	60.5	3.19	81.0	6.50	165.0	3.70	93.9	.32	8.0	20
24GSP-24FL90SXBULK	7347-4772	1 1/2	38.1	1 1/2	2.38	60.3	3.19	81.0	7.24	184.0	4.33	109.9	.32	8.0	12

\* -16FL Max. W.P. 5,000 psi; -20FL Max. W.P. 4,000 psi; -24FL Max. W.P. 3,000 psi; -32FL Max. W.P. 2,000 psi.

EQUIPMENT
HOSE/CPLG. SELECTION
<b>GLOBALSPIRAL COUPLINGS</b>
PCM/PCS FERRULES
MEGACRIMP COUPLINGS
POWER CRIMP COUPLINGS
LOW PRESSURE COUPLINGS
POLARSEAL COUPLINGS
C14 COUPLINGS
PCTS THERMO-PLASTIC COUPLINGS
FIELD ATTACHABLE G1 & G2 COUPLINGS
FIELD ATTACHABLE C5 COUPLINGS
SURELOK AIR BRAKE COUPLINGS
QUICK DISCONNECT COUPLERS
NEW BALL VALVES
ACCESSORIES
EQUIPMENT AND PARTS



## Code 61 O-Ring Flange - 90° Medium Bent Tube

S, M and L Drops per ISO Final Draft International Standard 12151-3.  
See Accessories for O-Rings.

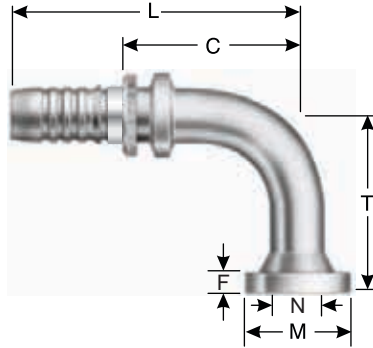

Descr.	Prod. No.	⊖		N	M		T		L		C		F		Std. Pack	
		"	mm		"	"	mm	"	mm	"	mm	"	mm	"		mm
<b>STANDARD PACK</b>																
POLARSEAL COUPLINGS	6GS-8FL90M	7347-74155	3/8	9.5	1/2	1.19	30.2	1.57	40.0	3.43	87.0	2.02	51.2	.27	6.7	1
	8GS-8FL90M	7347-74245	1/2	12.7	1/2	1.19	30.2	1.57	40.0	3.46	88.0	1.99	50.5	.27	6.7	1
	8GS-12FL90M	7347-74265	1/2	12.7	3/4	1.50	38.1	2.28	58.0	3.46	88.0	1.98	50.4	.27	6.7	1
C14 COUPLINGS	10GS-12FL90M	7347-74355	5/8	15.8	3/4	1.50	38.1	2.28	58.0	4.33	110.0	2.35	59.7	.27	6.7	1
	12GS-12FL90M	7347-74445	3/4	19.1	3/4	1.50	38.1	2.28	58.0	4.41	112.0	2.40	61.0	.27	6.7	1
	12GS-16FL90M*	7347-73925	3/4	19.1	1	1.75	44.5	2.76	70.0	4.41	112.0	2.40	61.0	.32	8.0	1
PCTS THERMO-PLASTIC COUPLINGS	16GS-12FL90	7347-73255	1	25.4	3/4	1.50	38.1	3.15	80.0	5.31	135.0	3.10	78.6	.27	6.7	1
	16GS-12FL90M	7347-74535	1	25.4	3/4	1.50	38.1	2.28	58.0	5.31	135.0	5.08	78.2	.27	6.7	1
	16GS-16FL90-210	7347-78875	1	25.4	1	1.75	44.5	8.27	210.0	5.28	134.0	3.02	76.8	.32	8.0	1
	16GS-16FL90M*	7347-74555	1	25.4	1	1.75	44.5	2.76	70.0	5.31	135.0	3.09	78.6	.32	8.0	1
	16GS-20FL90M*	7347-74565	1	25.4	1 1/4	2.00	50.8	3.54	90.0	5.28	134.0	2.99	76.0	.32	8.0	1
FIELD ATTACHABLE G1 & G2 COUPLINGS	20GS-16FL90-215	7347-78885	1 1/4	31.7	1	1.75	44.5	8.46	215.0	6.30	160.0	3.50	88.9	.32	8.0	1
	20GS-16FL90M*	7347-74635	1 1/4	31.7	1	1.75	44.5	2.76	70.0	6.30	160.0	3.50	88.9	.32	8.0	1
	20GS-20FL90M*	7347-74645	1 1/4	31.7	1 1/4	2.00	50.8	3.54	90.0	6.50	165.0	3.70	93.9	.32	8.0	1
	20GS-24FL90-118*	7347-76085	1 1/4	31.7	1 1/2	2.38	60.5	4.65	118.0	6.50	165.0	3.70	93.9	.32	8.0	1
	23GSP-24FL90M	7347-74725	1 1/2	38.1	1 1/2	2.36	60.3	4.09	104.0	6.89	175.0	4.01	101.9	.32	8.0	1
<b>BULK PACK</b>																
FIELD ATTACHABLE C5 COUPLINGS	8GS-8FL90MXBULK	7347-7424	1/2	12.7	1/2	1.19	30.2	1.57	40.0	3.46	88.0	1.99	50.5	.27	6.7	100
	8GS-12FL90MXBULK	7347-7426	1/2	12.7	3/4	1.50	38.1	2.28	58.0	3.46	88.0	1.98	50.4	.27	6.7	60
	12GS-12FL90MXBULK	7347-7444	3/4	19.1	3/4	1.50	38.1	2.28	58.0	4.41	112.0	2.40	61.0	.27	6.7	50
	12GS-16FL90MXBULK	7347-7392	3/4	19.1	1	1.75	44.5	2.76	70.0	4.41	112.0	2.40	61.0	.32	8.0	30
	16GS-16FL90MXBULK	7347-7455	1	25.4	1	1.75	44.5	2.76	70.0	5.31	135.0	3.09	78.6	.32	8.0	25
SURELOK AIR BRAKE COUPLINGS	16GS-20FL90MXBULK	7347-7456	1	25.4	1 1/4	2.00	50.8	3.54	90.0	5.28	134.0	2.99	76.0	.32	8.0	25
	20GS-20FL90MXBULK	7347-7464	1 1/4	31.7	1 1/4	2.00	50.8	3.54	90.0	6.50	165.0	3.70	93.9	.32	8.0	15
	24GSP-24FL90MXBULK	7347-7472	1 1/2	38.1	1 1/2	2.36	60.3	4.09	104.0	6.89	175.0	4.01	101.9	.32	8.0	10

\* -16FL Max. W.P. 5,000 psi; -20FL Max. W.P. 4,000 psi; -24FL Max. W.P. 3,000 psi; -32FL Max. W.P. 2,000 psi.



## Code 61 O-Ring Flange - 90° Long Bent Tube

S, M and L Drops per ISO Final Draft International Standard 12151-3.  
See Accessories for O-Rings.

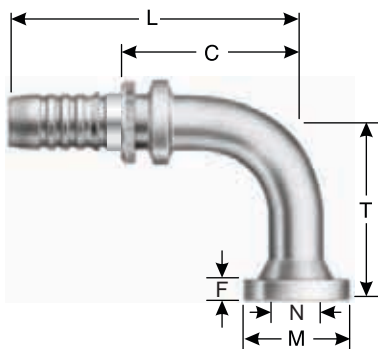

Descr.	Prod. No.	⊖		N		M		T		L		C		F		Std. Pack
		"	mm	"	"	mm	"	mm	"	mm	"	mm	"	mm	"	
<b>STANDARD PACK</b>																
8GS-8FL90L	7347-73815	1/2	12.7	1/2	1.19	30.2	3.27	83.0	3.46	88.0	1.99	50.5	.27	6.7	1	
12GS-16FL90-080*	7347-76805	3/4	19.1	1	1.75	44.5	3.15	80.0	5.04	128.0	3.03	77.0	.32	8.0	1	
24GSP-24FL90-148	7347-85625	1 1/2	38.1	1 1/2	2.36	60.3	5.83	148.0	6.89	175.0	4.01	101.9	.32	8.0	1	

\* -16FL Max. W.P. 5,000 psi; -20FL Max. W.P. 4,000 psi; -24FL Max. W.P. 3,000 psi; -32FL Max. W.P. 2,000 psi.

## Code 61 O-Ring Flange - 90° Bent Tube

S, M and L Drops per ISO Final Draft International Standard 12151-3.  
See Accessories for O-Rings.

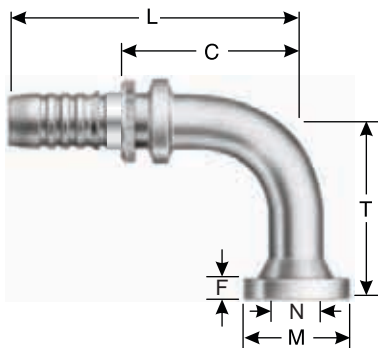

Descr.	Prod. No.	⊖		N		M		T		L		C		F		Std. Pack
		"	mm	"	"	mm	"	mm	"	mm	"	mm	"	mm		
<b>STANDARD PACK</b>																
12GS-12FL90-100	7347-73905	3/4	19.1	3/4	1.50	38.1	3.94	100.0	4.41	112.0	2.40	61.0	.27	6.7	1	
12GS-12FL90-125	7347-73985	3/4	19.1	3/4	1.50	38.1	4.92	125.0	4.80	122.0	2.80	71.0	.27	6.7	1	
12GS-16FL90-178	7347-79025	3/4	19.1	1	1.75	44.5	7.01	178.0	4.41	112.0	2.38	60.5	.32	8.0	1	
12GS-20FL90-125*	7347-78375	3/4	19.1	1 1/4	2.00	50.8	4.92	125.0	4.76	121.0	2.76	70.0	.32	8.0	1	
16GS-16FL90-120*	7347-73165	1	25.4	1	1.75	44.5	4.72	120.0	5.28	134.0	3.04	77.2	.32	8.0	1	
20GS-20FL90-168*	7347-76105	1 1/4	31.7	1 1/4	2.00	50.8	6.61	168.0	6.54	166.0	3.74	94.9	.32	8.0	1	
32GSP-32FL90-114	7347-47805	2	50.8	2	2.81	71.4	4.49	114.0	8.74	222.0	5.12	130.1	.38	9.5	1	
32GSP-32FL90-165	7347-85425	2	50.8	2	2.81	71.4	6.50	165.0	9.69	246.0	6.06	154.0	.38	9.5	1	
<b>BULK PACK</b>																
12GS-12FL90-100XBULK	7347-7390	3/4	19.1	3/4	1.50	38.1	3.94	100.0	4.41	112.0	2.40	61.0	.27	6.7	50	

EQUIPMENT
HOSE/CPLG. SELECTION
<b>GLOBALSPIRAL COUPLINGS</b>
PCM/PCS FERRULES
MEGACRIMP COUPLINGS
POWER CRIMP COUPLINGS
LOW PRESSURE COUPLINGS
POLARSEAL COUPLINGS
C14 COUPLINGS
PCTS THERMO-PLASTIC COUPLINGS
FIELD ATTACHABLE G1 & G2 COUPLINGS
FIELD ATTACHABLE C5 COUPLINGS
SURELOK AIR BRAKE COUPLINGS
QUICK DISCONNECT COUPLERS
NEW BALL VALVES
ACCESSORIES
EQUIPMENT AND PARTS





# GlobalSpiral™ Couplings

EQUIPMENT
HOSE/CPLG. SELECTION
GLOBALSPIRAL COUPLINGS
PCM/PCS FERRULES
MEGACRIMP COUPLINGS
POWER CRIMP COUPLINGS
LOW PRESSURE COUPLINGS
POLARSEAL COUPLINGS
C14 COUPLINGS
PCTS THERMO-PLASTIC COUPLINGS
FIELD ATTACHABLE G1 & G2 COUPLINGS
FIELD ATTACHABLE C5 COUPLINGS
SURELOK AIR BRAKE COUPLINGS
QUICK DISCONNECT COUPLERS
NEW BALL VALVES
ACCESSORIES
EQUIPMENT AND PARTS

## Code 61 O-Ring Flange - 90° Bent Tube - Cont'd

Descr.	Prod. No.	⊖		N		M		T		L		C		F		Std. Pack
		"	mm	"	"	mm	"	mm	"	mm	"	mm	"	mm		
16GS-16FL90-120XBULK	7347-7316	1	25.4	1	1.75	44.5	4.72	120.0	5.28	134.0	3.04	77.2	.32	8.0	25	
32GSP-32FL90-114XBULK	7347-4780	2	50.8	2	2.81	71.4	4.49	114.0	8.74	222.0	5.12	130.1	.38	9.5	5	

\* -16FL Max. W.P. 5,000 psi; -20FL Max. W.P. 4,000 psi; -24FL Max. W.P. 3,000 psi; -32FL Max. W.P. 2,000 psi.

## Code 61 O-Ring Flange - 100° Bent Tube

See Accessories for O-Rings.

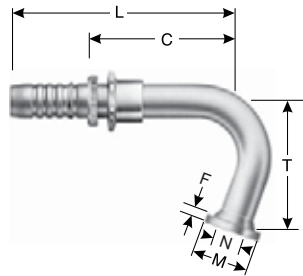

Descr.	Prod. No.	⊖		N		M		T		L		C		F		Std. Pack
		"	mm	"	"	mm	"	mm	"	mm	"	mm	"	mm		
<b>STANDARD PACK</b>																
12GS-16FL100-059*	7347-78055	3/4	19.1	1	1.75	44.4	2.32	59.0	4.93	125.2	2.92	74.2	.32	8.0	1	

\* -16FL Max. W.P. 5,000 psi; -20FL Max. W.P. 4,000 psi; -24FL Max. W.P. 3,000 psi; -32FL Max. W.P. 2,000 psi.

## Code 61 O-Ring Flange - 110° Bent Tube

See Accessories for O-Rings.

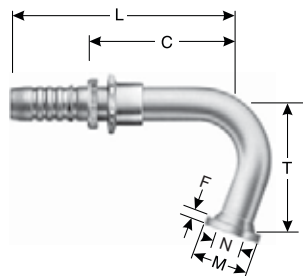

Descr.	Prod. No.	⊖		N		M		T		L		C		F		Std. Pack
		"	mm	"	"	mm	"	mm	"	mm	"	mm	"	mm		
<b>STANDARD PACK</b>																
12GS-12FL110-064	7347-76025	3/4	19.1	3/4	1.50	38.1	2.52	64.0	5.16	131.0	3.15	80.0	.27	6.7	1	
16GS-16FL110-073*	7347-73005	1	25.4	1	1.75	44.5	2.87	73.0	5.83	148.0	3.61	91.6	.32	8.0	1	
16GS-20FL110-073*	7347-76455	1	25.4	1 1/4	2.00	50.8	2.87	73.0	4.65	118.0	2.41	61.2	.32	8.0	1	
20GS-20FL110-080*	7347-76115	1 1/4	31.7	1 1/4	2.00	50.8	3.15	80.0	7.13	181.0	4.33	109.9	.32	8.0	1	
20GS-24FL110-080*	7347-76125	1 1/4	31.7	1 1/2	2.38	60.5	3.15	80.0	7.13	181.0	4.33	109.9	.32	8.0	1	

\* -16FL Max. W.P. 5,000 psi; -20FL Max. W.P. 4,000 psi; -24FL Max. W.P. 3,000 psi; -32FL Max. W.P. 2,000 psi.





## Code 61 O-Ring Flange - 135° Bent Tube

See Accessories for O-Rings.

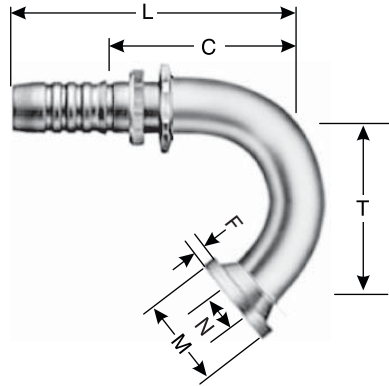

Descr.	Prod. No.	⊖		N	M		T		L		C		F		Std. Pack
		"	mm		"	"	mm	"	mm	"	mm	"	mm	"	
<b>STANDARD PACK</b>															
12GS-12FL135-070	7347-76825	3/4	19.1	3/4	1.50	38.1	2.76	70.0	3.82	97.0	1.81	46.0	.27	6.7	1

## Code 61 Komatsu Style O-Ring Flange

See Accessories for O-Rings.

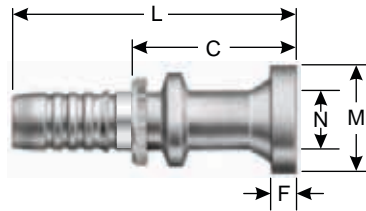

Descr.	Prod. No.	⊖		N	M		L		C		F		Std. Pack
		"	mm		"	"	mm	"	mm	"	mm	"	
<b>STANDARD PACK</b>													
8GS-10FLK	7347-55255	1/2	12.7	5/8	1.35	34.2	3.21	81.5	1.74	44.1	.27	6.7	1
10GS-10FLK	7347-73335	5/8	15.8	5/8	1.35	34.2	4.49	114.0	2.51	63.7	.27	6.7	1
12GS-10FLK	7347-73375	3/4	19.1	5/8	1.35	34.2	4.33	110.0	2.32	59.0	.27	6.7	1
<b>BULK PACK</b>													
8GS-10FLKXBULK	7347-5525	1/2	12.7	5/8	1.35	34.2	3.21	81.5	1.74	44.1	.27	6.7	60

EQUIPMENT

HOSE/CPLG. SELECTION

GLOBALSPIRAL COUPLINGS

PCM/PCS FERRULES

MEGACRIMP COUPLINGS

POWER CRIMP COUPLINGS

LOW PRESSURE COUPLINGS

POLARSEAL COUPLINGS

C14 COUPLINGS

PCTS THERMO-PLASTIC COUPLINGS

FIELD ATTACHABLE G1 & G2 COUPLINGS

FIELD ATTACHABLE C5 COUPLINGS

SURELOK AIR BRAKE COUPLINGS

QUICK DISCONNECT COUPLERS

NEW BALL VALVES

ACCESSORIES

EQUIPMENT AND PARTS





# GlobalSpiral™ Couplings

EQUIPMENT

HOSE/CPLG. SELECTION

GLOBALSPIRAL COUPLINGS

PCM/PCS FERRULES

MEGACRIMP COUPLINGS

POWER CRIMP COUPLINGS

LOW PRESSURE COUPLINGS

POLARSEAL COUPLINGS

C14 COUPLINGS

PCTS THERMO-PLASTIC COUPLINGS

FIELD ATTACHABLE G1 & G2 COUPLINGS

FIELD ATTACHABLE C5 COUPLINGS

SURELOK AIR BRAKE COUPLINGS

QUICK DISCONNECT COUPLERS

NEW BALL VALVES

ACCESSORIES

EQUIPMENT AND PARTS

## Code 61 Komatsu Style O-Ring Flange - 45° Short Bent Tube

S, M and L Drops per ISO Final Draft International Standard 12151-3.  
See Accessories for O-Rings.

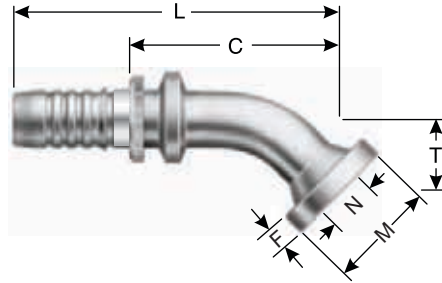

Descr.	Prod. No.	⊖		N	M		T		L		C		F		Std. Pack
		"	mm	"	"	mm	"	mm	"	mm	"	mm	"	mm	
<b>STANDARD PACK</b>															
10GS-10FLK45-026	7347-73365	5/8	15.8	5/8	1.35	34.2	1.02	26.0	4.76	121.0	2.78	70.7	.27	6.7	1

## Code 61 Komatsu Style O-Ring Flange - 90° Medium Bent Tube

S, M and L Drops per ISO Final Draft International Standard 12151-3.  
See Accessories for O-Rings.

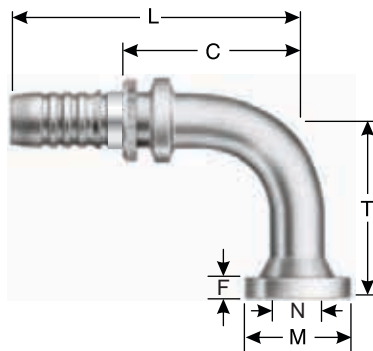

Descr.	Prod. No.	⊖		N	M		T		L		C		F		Std. Pack
		"	mm	"	"	mm	"	mm	"	mm	"	mm	"	mm	
<b>STANDARD PACK</b>															
10GS-10FLK90-055	7347-73355	5/8	15.8	5/8	1.35	34.2	2.17	55.0	4.33	110.0	2.35	59.7	.27	6.7	1
12GS-10FLK90-055	7347-73695	3/4	19.1	5/8	1.35	34.2	2.17	55.0	4.65	118.0	2.64	67.0	.27	6.7	1





## Code 62 O-Ring Flange Heavy

See Accessories for O-Rings.

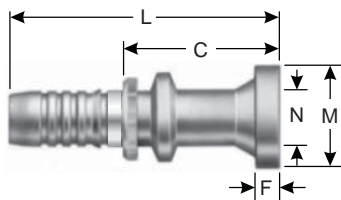

Descr.	Prod. No.	⊖		N	M		L		C		F		Std. Pack
		"	mm		"	"	mm	"	mm	"	mm	"	
<b>STANDARD PACK</b>													
8GS-8FLH	7347-48245	1/2	12.7	1/2	1.25	31.8	3.66	93.0	2.19	55.5	.31	7.8	1
8GS-12FLH	7347-48265	1/2	12.7	3/4	1.63	41.4	3.66	93.0	2.19	55.5	.35	8.8	1
10GS-8FLH	7347-48335	5/8	15.8	1/2	1.25	31.8	4.29	109.0	2.31	58.7	.31	7.8	1
10GS-12FLH	7347-48355	5/8	15.8	3/4	1.63	41.4	4.29	109.0	2.31	58.7	.35	8.8	1
12GS-12FLH	7347-48445	3/4	19.1	3/4	1.63	41.4	4.49	114.0	2.48	63.0	.35	8.8	1
12GS-16FLH	7347-48465	3/4	19.1	1	1.88	47.8	4.49	114.0	2.48	63.0	.38	9.5	1
16GS-12FLH	7347-48535	3/4	19.1	3/4	1.63	41.4	5.08	129.0	2.86	72.6	.35	8.8	1
16GS-16FLH	7347-48555	1	25.4	1	1.88	47.8	4.92	125.0	2.70	68.6	.38	9.5	1
16GS-20FLH	7347-48565	1	25.4	1 1/4	2.13	54.1	4.92	125.0	2.69	68.2	.41	10.3	1
20GS-16FLH	7347-48635	1	25.4	1	1.88	47.8	6.42	163.0	3.62	91.9	.38	9.5	1
20GS-20FLH	7347-48645	3/8	9.5	1 1/4	2.13	54.1	5.75	146.0	2.95	74.9	.41	10.3	1
20GS-24FLH	7347-48655	1 1/4	31.7	1 1/2	2.50	63.5	6.30	160.0	3.50	88.9	.50	12.6	1
24GSP-24FLH	7347-48725	1 1/2	38.1	1 1/2	2.50	63.5	6.57	167.0	3.68	93.4	.50	12.6	1
32GSP-32FLH	7347-48795	2	50.8	2	3.13	79.4	7.09	180.0	3.46	88.0	.50	12.6	1
<b>BULK PACK</b>													
8GS-8FLHXBULK	7347-4824	1/2	12.7	1/2	1.25	31.8	3.66	93.0	2.19	55.5	.31	7.8	50
12GS-12FLHXBULK	7347-4844	3/4	19.1	3/4	1.63	41.4	4.49	114.0	2.48	63.0	.35	8.8	70
16GS-16FLHXBULK	7347-4855	1	25.4	1	1.88	47.8	4.92	125.0	2.70	68.6	.38	9.5	40
16GS-20FLHXBULK	7347-4856	1	25.4	1 1/4	2.13	54.1	4.92	125.0	2.69	68.2	.41	10.3	35
20GS-16FLHXBULK	7347-4863	1	25.4	1	1.88	47.8	6.42	163.0	3.62	91.9	.38	9.5	25
20GS-20FLHXBULK	7347-4864	3/8	9.5	1 1/4	2.13	54.1	5.75	146.0	2.95	74.9	.41	10.3	25
24GSP-24FLHXBULK	7347-4872	1 1/2	38.1	1 1/2	2.50	63.5	6.57	167.0	3.68	93.4	.50	12.6	20

## Code 62 O-Ring Flange Heavy - 22½° Bent Tube

S, M and L Drops per ISO Final Draft International Standard 12151-3.

See Accessories for O-Rings.

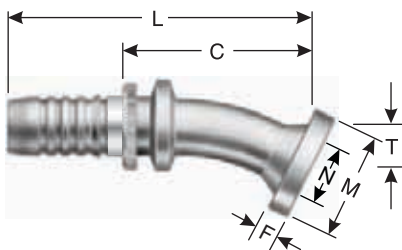

Descr.	Prod. No.	⊖		N	M		T		L		C		F		Std. Pack
		"	mm		"	"	mm	"	mm	"	mm	"	mm		
<b>STANDARD PACK</b>															
12GS-16FLH22M	7347-49465	3/4	19.1	1	1.88	47.8	.55	14.0	5.43	138.0	3.43	87.0	.38	9.5	1

EQUIPMENT
HOSE/CPLG. SELECTION
<b>GLOBALSPIRAL COUPLINGS</b>
PCM/PCS FERRULES
MEGACRIMP COUPLINGS
POWER CRIMP COUPLINGS
LOW PRESSURE COUPLINGS
POLARSEAL COUPLINGS
C14 COUPLINGS
PCTS THERMO-PLASTIC COUPLINGS
FIELD ATTACHABLE G1 & G2 COUPLINGS
FIELD ATTACHABLE C5 COUPLINGS
SURELOK AIR BRAKE COUPLINGS
QUICK DISCONNECT COUPLERS
NEW BALL VALVES
ACCESSORIES
EQUIPMENT AND PARTS



# GlobalSpiral™ Couplings

## Code 62 O-Ring Flange Heavy - 22½° Bent Tube - Cont'd

Descr.	Prod. No.	⊖		N		M		T		L		C		F		Std. Pack
		"	mm	"	"	mm	"	mm	"	mm	"	mm	"	mm		
16GS-16FLH22M	7347-49555	1	25.4	1	1.88	47.8	.55	14.0	6.10	155.0	3.88	98.6	.38	9.5	1	
20GS-20FLH22M	7347-49645	1 1/4	31.7	1 1/4	2.13	54.1	.59	15.0	7.32	186.0	4.52	114.9	.41	10.3	1	
20GS-24FLH22M	7347-49655	1 1/4	31.7	1 1/2	2.50	63.5	.71	18.0	7.40	188.0	4.60	116.9	.50	12.6	1	

## Code 62 O-Ring Flange Heavy - 30° Bent Tube

S, M and L Drops per ISO Final Draft International Standard 12151-3.  
See Accessories for O-Rings.

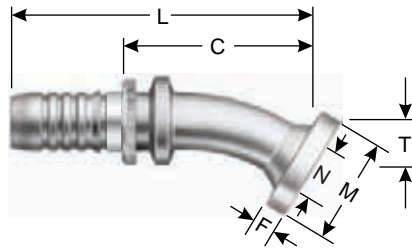

Descr.	Prod. No.	⊖		N		M		T		L		C		F		Std. Pack
		"	mm	"	"	mm	"	mm	"	mm	"	mm	"	mm		
<b>STANDARD PACK</b>																
12GS-12FLH30M	7347-50445	3/4	19.1	3/4	1.63	41.4	.63	16.0	5.08	129.0	3.07	78.0	.35	8.8	1	
16GS-16FLH30M	7347-50555	1	25.4	1	1.88	47.8	.75	19.0	6.02	153.0	3.80	96.6	.38	9.5	1	
16GS-20FLH30M	7347-50565	1	25.4	1 1/4	2.13	54.1	1.50	38.0	6.22	158.0	3.98	101.2	.41	10.3	1	
20GS-20FLH30M	7347-50645	1 1/4	31.7	1 1/4	2.13	54.1	.87	22.0	7.24	184.0	4.44	112.9	.41	10.3	1	
20GS-24FLH30M	7347-50655	1 1/4	31.7	1 1/2	2.50	63.5	1.18	30.0	7.24	184.0	4.44	112.9	.50	12.6	1	

## Code 62 O-Ring Flange Heavy - 45° Bent Tube

S, M and L Drops per ISO Final Draft International Standard 12151-3.  
See Accessories for O-Rings.

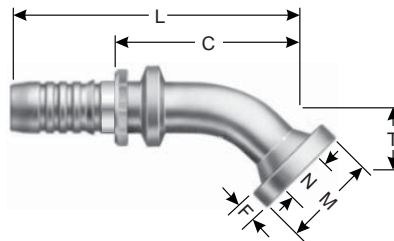

Descr.	Prod. No.	⊖		N		M		T		L		C		F		Std. Pack
		"	mm	"	"	mm	"	mm	"	mm	"	mm	"	mm		
<b>STANDARD PACK</b>																
8GS-8FLH45M	7347-51245	1/2	12.7	1/2	1.25	31.8	.75	19.0	3.70	94.0	2.22	56.5	.31	7.9	1	
8GS-12FLH45M	7347-51265	5/8	15.8	3/4	1.63	41.4	1.02	26.0	3.98	101.0	2.50	63.5	.35	8.8	1	
10GS-12FLH45M	7347-51355	5/8	15.8	3/4	1.63	41.4	1.02	26.0	5.00	127.0	3.02	76.7	.35	8.8	1	
12GS-8FLH45M	7347-51425	3/4	19.1	1/2	1.25	31.8	.75	19.0	4.56	115.7	2.55	64.7	.31	7.8	1	
12GS-12FLH45M	7347-51445	3/4	19.1	3/4	1.63	41.4	1.02	26.0	4.88	124.0	2.87	73.0	.35	8.8	1	
12GS-16FLH45M	7347-51465	3/4	19.1	1	1.88	47.8	1.26	32.0	5.12	130.0	3.11	79.0	.38	9.5	1	
16GS-12FLH45M	7347-51535	1	25.4	3/4	1.63	41.4	1.02	26.0	5.55	141.0	3.33	84.6	.35	8.8	1	





## Code 62 O-Ring Flange Heavy - 45° Bent Tube - Cont'd

Descr.	Prod. No.	⊖		N		M		T		L		C		F		Std. Pack
		"	mm	"	"	mm	"	mm	"	mm	"	mm	"	mm		
16GS-16FLH45M	7347-51555	1	25.4	1	1.88	47.8	1.26	32.0	5.79	147.0	3.57	90.6	.38	9.5	1	
16GS-20FLH45M	7347-51565	1	25.4	1 1/4	2.13	54.1	1.50	38.0	6.22	158.0	3.98	101.2	.41	10.3	1	
20GS-16FLH45M	7347-51635	1 1/4	31.7	1	1.88	47.6	1.26	32.0	6.73	171.0	3.93	99.7	.38	9.5	1	
20GS-20FLH45M	7347-51645	1 1/4	31.7	1 1/4	2.13	54.1	1.50	38.0	6.93	176.0	4.13	104.9	.41	10.3	1	
20GS-24FLH45M	7347-51655	1 1/4	31.7	1 1/2	2.50	63.5	1.73	44.0	6.93	176.0	4.13	104.9	.50	12.6	1	
24GSP-24FLH45M	7347-51725	1 1/2	38.1	1 1/2	2.50	63.5	1.73	44.0	7.56	192.0	4.65	118.0	.50	12.6	1	
32GSP-32FLH45-066	7347-51805	2	50.8	2	3.13	79.4	2.60	66.0	10.67	271.0	7.06	179.2	.50	12.6	1	
<b>BULK PACK</b>																
12GS-16FLH45MXBULK	7347-5146	3/4	19.1	1	1.88	47.8	1.26	32.0	5.12	130.0	3.11	79.0	.38	9.5	40	
16GS-16FLH45MXBULK	7347-5155	1	25.4	1	1.88	47.8	1.26	32.0	5.79	147.0	3.57	90.6	.38	9.5	35	
24GSP-24FLH45MXBULK	7347-5172	1 1/2	38.1	1 1/2	2.50	63.5	1.73	44.0	7.56	192.0	4.65	118.0	.50	12.6	15	

## Code 62 O-Ring Flange Heavy - 60° Bent Tube

S, M and L Drops per ISO Final Draft International Standard 12151-3.  
See Accessories for O-Rings.

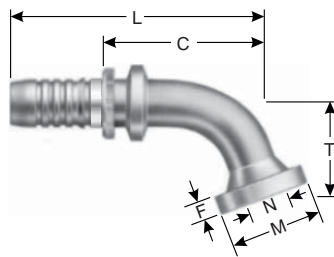

Descr.	Prod. No.	⊖		N		M		T		L		C		F		Std. Pack
		"	mm	"	"	mm	"	mm	"	mm	"	mm	"	mm		
<b>STANDARD PACK</b>																
12GS-12FLH60M	7347-52445	3/4	19.1	3/4	1.63	41.4	1.46	37.0	5.39	137.0	3.39	86.0	.35	8.8	1	
12GS-16FLH60M	7347-52465	3/4	19.1	1	1.88	47.8	1.73	44.0	5.35	136.0	3.35	85.0	.38	9.5	1	
16GS-16FLH60M	7347-52555	1	25.4	1	1.88	47.8	1.73	44.0	6.18	157.0	3.96	100.8	.38	9.5	1	
20GS-20FLH60M	7347-52645	1 1/4	31.7	1 1/4	2.13	54.1	2.17	55.0	7.32	186.0	4.52	114.9	.41	10.3	1	
20GS-24FLH60M	7347-52655	1 1/4	31.7	1 1/2	2.50	63.5	2.52	64.0	7.64	194.0	4.84	122.9	.50	12.6	1	

EQUIPMENT
HOSE/CPLG. SELECTION
<b>GLOBALSPIRAL COUPLINGS</b>
PCM/PCS FERRULES
MEGACRIMP COUPLINGS
POWER CRIMP COUPLINGS
LOW PRESSURE COUPLINGS
POLARSEAL COUPLINGS
C14 COUPLINGS
PCTS THERMO-PLASTIC COUPLINGS
FIELD ATTACHABLE G1 & G2 COUPLINGS
FIELD ATTACHABLE C5 COUPLINGS
SURELOK AIR BRAKE COUPLINGS
QUICK DISCONNECT COUPLERS
NEW BALL VALVES
ACCESSORIES
EQUIPMENT AND PARTS





# GlobalSpiral™ Couplings

EQUIPMENT

HOSE/CPLG. SELECTION

GLOBALSPIRAL COUPLINGS

PCM/PCS FERRULES

MEGACRIMP COUPLINGS

POWER CRIMP COUPLINGS

LOW PRESSURE COUPLINGS

POLARSEAL COUPLINGS

C14 COUPLINGS

PCTS THERMO-PLASTIC COUPLINGS

FIELD ATTACHABLE G1 & G2 COUPLINGS

FIELD ATTACHABLE C5 COUPLINGS

SURELOK AIR BRAKE COUPLINGS

QUICK DISCONNECT COUPLERS

NEW BALL VALVES

ACCESSORIES

EQUIPMENT AND PARTS

## Code 62 O-Ring Flange Heavy - 67½° Bent Tube

S, M and L Drops per ISO Final Draft International Standard 12151-3.  
See Accessories for O-Rings.

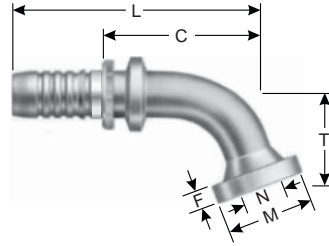

Descr.	Prod. No.	⊖		N		M		T		L		C		F		Std. Pack
		"	mm	"	"	mm	"	mm	"	mm	"	mm	"	mm		
<b>STANDARD PACK</b>																
16GS-16FLH67M	7347-53555	1	25.4	1	1.88	47.8	2.01	51.0	5.94	151.0	3.72	94.6	.38	9.5	1	

## Code 62 O-Ring Flange Heavy - 90° Short Bent Tube

S, M and L Drops per ISO Final Draft International Standard 12151-3.  
See Accessories for O-Rings.

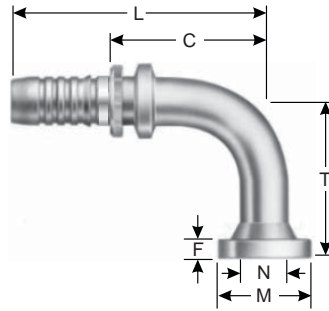

Descr.	Prod. No.	⊖		N		M		T		L		C		F		Std. Pack
		"	mm	"	"	mm	"	mm	"	mm	"	mm	"	mm		
<b>STANDARD PACK</b>																
12GS-16FLH90S	7347-54465	3/4	19.1	1	1.88	47.8	2.40	61.0	4.41	112.0	2.40	61.0	.38	9.5	1	
16GS-16FLH90S	7347-54555	1	25.4	1	1.88	47.8	2.40	61.0	5.31	135.0	3.09	78.6	.38	9.5	1	
16GS-20FLH90S	7347-54565	1	25.4	1 1/4	2.13	54.1	2.68	68.0	5.28	134.0	3.02	76.8	.41	10.3	1	
16GS-24FLH90S	7347-54575	1	25.4	1 1/2	2.50	63.5	3.19	81.0	5.28	134.0	3.04	77.2	.50	12.6	1	
20GS-16FLH90S	7347-54635	1 1/4	31.7	1	1.88	47.8	2.40	61.0	6.30	160.0	3.50	88.9	.38	9.5	1	
20GS-20FLH90-076	7347-73635	1 1/4	31.7	1 1/4	2.13	54.1	2.99	76.0	6.50	165.0	3.70	93.9	.41	10.3	1	
20GS-24FLH90S	7347-54655	1 1/4	31.7	1 1/2	2.50	63.5	3.19	81.0	6.50	165.0	3.70	93.9	.50	12.6	1	
<b>BULK PACK</b>																
16GS-16FLH90SXBULK	7347-5455	1	25.4	1	1.88	47.8	2.40	61.0	5.31	135.0	3.09	78.6	.38	9.5	25	
16GS-20FLH90SXBULK	7347-5456	1	25.4	1 1/4	2.13	54.1	2.68	68.0	5.28	134.0	3.02	76.8	.41	10.3	20	





## Code 62 O-Ring Flange Heavy - 90° Medium Bent Tube

S, M and L Drops per ISO Final Draft International Standard 12151-3.  
See Accessories for O-Rings.

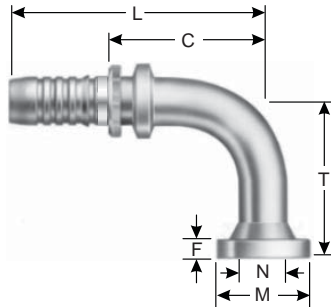

Descr.	Prod. No.	Ø		N	M		T		L		C		F		Std. Pack
		"	mm		"	"	mm	"	mm	"	mm	"	mm	"	
<b>STANDARD PACK</b>															
8GS-8FLH90M	7347-75245	1/2	12.7	1/2	1.25	31.8	1.57	40.0	3.46	88.0	1.99	50.5	.31	7.8	1
8GS-12FLH90M	7347-75265	1/2	12.7	3/4	1.63	41.4	2.28	58.0	3.46	88.0	1.99	50.5	.35	8.8	1
10GS-8FLH90M	7347-75335	5/8	15.8	1/2	1.25	31.8	1.57	40.0	4.45	113.0	2.47	62.7	.31	7.8	1
10GS-12FLH90M	7347-75355	5/8	15.8	3/4	1.63	41.4	2.28	58.0	4.33	110.0	2.35	59.7	.35	8.8	1
12GS-12FLH90M	7347-75445	3/4	19.1	3/4	1.63	41.4	2.28	58.0	4.41	112.0	2.40	61.0	.35	8.8	1
12GS-16FLH90M	7347-73935	3/4	19.1	1	1.88	47.8	2.76	70.0	4.41	112.0	2.40	61.0	.38	9.5	1
12GS-20FLH90M	7347-75475	3/4	19.1	1 1/4	2.13	54.0	3.54	90.0	4.80	122.0	2.80	71.0	.41	10.3	1
16GS-12FLH90M	7347-54535	1	25.4	3/4	1.63	41.4	2.28	58.0	5.31	135.0	3.09	78.6	.35	8.8	1
16GS-16FLH90M	7347-75555	1	25.4	1	1.88	47.8	2.76	70.0	5.31	135.0	3.09	78.6	.38	9.5	1
16GS-20FLH90M	7347-75565	1	25.4	1 1/4	2.13	54.1	3.54	90.0	5.28	134.0	3.02	76.8	.41	10.3	1
20GS-16FLH90M	7347-75635	1 1/4	31.7	1	1.88	47.8	2.76	70.0	6.30	160.0	3.50	88.9	.38	9.5	1
20GS-20FLH90M	7347-75645	1 1/4	31.7	1 1/4	2.00	50.8	3.54	90.0	6.50	165.0	3.70	93.9	.32	8.0	1
24GSP-24FLH90-094	7347-79105	1 1/2	38.1	1 1/2	2.50	63.5	3.70	94.0	6.91	175.5	4.01	101.9	.50	12.6	1
32GSP-32FLH90M	7347-75795	2	50.8	2	3.13	79.4	5.40	138.0	8.72	221.4	5.09	129.4	.50	12.6	1
<b>BULK PACK</b>															
12GS-12FLH90MXBULK	7347-7544	3/4	19.1	3/4	1.63	41.4	2.28	58.0	4.41	112.0	2.40	61.0	.35	8.8	50
12GS-16FLH90MXBULK	7347-7393	3/4	19.1	1	1.88	47.8	2.76	70.0	4.41	112.0	2.40	61.0	.38	9.5	40
16GS-12FLH90MXBULK	7347-5453	1	25.4	3/4	1.63	41.4	2.28	58.0	5.31	135.0	3.09	78.6	.35	8.8	20
16GS-16FLH90MXBULK	7347-7555	1	25.4	1	1.88	47.8	2.76	70.0	5.31	135.0	3.09	78.6	.38	9.5	30
16GS-20FLH90MXBULK	7347-7556	1	25.4	1 1/4	2.13	54.1	3.54	90.0	5.28	134.0	3.02	76.8	.41	10.3	20
20GS-20FLH90MXBULK	7347-7564	1 1/4	31.7	1 1/4	2.00	50.8	3.54	90.0	6.50	165.0	3.70	93.9	.32	8.0	15

EQUIPMENT

HOSE/CPLG. SELECTION

GLOBALSPIRAL COUPLINGS

PCM/PCS FERRULES

MEGACRIMP COUPLINGS

POWER CRIMP COUPLINGS

LOW PRESSURE COUPLINGS

POLARSEAL COUPLINGS

C14 COUPLINGS

PCTS THERMO-PLASTIC COUPLINGS

FIELD ATTACHABLE G1 & G2 COUPLINGS

FIELD ATTACHABLE C5 COUPLINGS

SURELOK AIR BRAKE COUPLINGS

QUICK DISCONNECT COUPLERS

NEW BALL VALVES

ACCESSORIES

EQUIPMENT AND PARTS



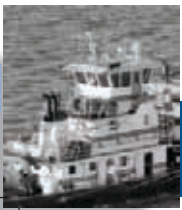

# GlobalSpiral™ Couplings

## Code 62 O-Ring Flange Heavy - 90° Long Bent Tube

S, M and L Drops per ISO Final Draft International Standard 12151-3.  
See Accessories for O-Rings.

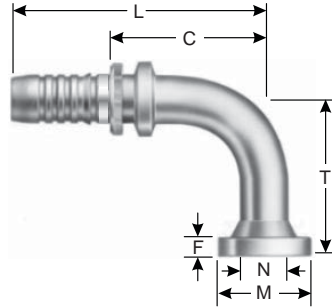

Descr.	Prod. No.	⊖		N	M		T		L		C		F		Std. Pack
		"	mm		"	"	mm	"	mm	"	mm	"	mm	"	
<b>STANDARD PACK</b>															
8GS-8FLH90-080	7347-73825	1/2	12.7	1/2	1.25	31.8	3.15	80.0	3.46	88.0	1.99	50.5	.31	7.8	1
12GS-12FLH90-100	7347-73835	3/4	19.1	3/4	1.63	41.4	3.94	100.0	4.41	112.0	2.40	61.0	.35	8.8	1
16GS-16FLH90-120	7347-73015	1	25.4	1	1.88	47.8	4.72	120.0	5.28	134.0	3.04	77.2	.38	9.5	1
20GS-16FLH90-100	7347-76185	1 1/4	31.7	1	1.88	47.8	3.94	100.0	6.30	160.0	3.50	88.9	.38	9.5	1
20GS-20FLH90-120	7347-76135	1 1/4	31.7	1 1/4	2.13	54.1	4.72	120.0	6.50	165.0	3.70	93.9	.41	10.3	1
<b>BULK PACK</b>															
16GS-16FLH90-120XBULK	7347-7301	1	25.4	1	1.88	47.8	4.72	120.0	5.28	134.0	3.04	77.2	.38	9.5	25

## Code 62 O-Ring Flange Heavy - 90° Extra Long Bent Tube

S, M and L Drops per ISO Final Draft International Standard 12151-3.  
See Accessories for O-Rings.

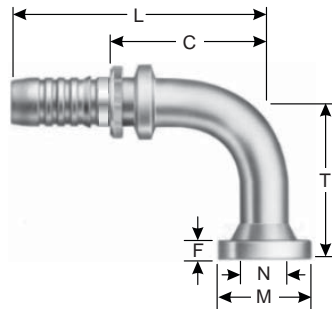

Descr.	Prod. No.	⊖		N	M		T		L		C		F		Std. Pack
		"	mm		"	"	mm	"	mm	"	mm	"	mm	"	
<b>STANDARD PACK</b>															
12GS-12FLH90-122	7347-76415	3/4	19.1	3/4	1.63	41.4	4.80	122.0	4.80	122.0	2.80	71.0	.35	8.8	1
12GS-16FLH90-140	7347-76715	3/4	19.1	1	1.88	47.8	5.51	140.0	4.57	116.0	2.56	65.0	.38	9.5	1
16GS-16FLH90-090	7347-78105	1	25.4	1	1.88	47.8	3.54	90.0	5.52	140.2	3.28	83.4	.38	9.5	1
20GS-20FLH90-152	7347-76485	1 1/4	31.7	1 1/4	2.13	54.1	5.98	152.0	6.50	165.0	3.70	93.9	.41	10.3	1





## Code 62 O-Ring Flange Heavy - 110° Bent Tube

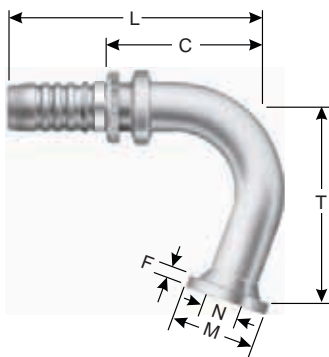

Descr.	Prod. No.	⊖		N		M		T		L		C		F		Std. Pack
		"	mm	"	"	mm	"	mm	"	mm	"	mm	"	mm		
<b>STANDARD PACK</b>																
12GS-12FLH110-064	7347-78525	3/4	19.1	3/4	1.50	38.1	2.76	70.0	3.82	97.0	1.81	46.0	.27	6.7	1	

## Caterpillar Style O-Ring Flange

Note: These FLC flanges are designed with a thicker flange head. The 0.56" flange dimension is frequently found on Caterpillar equipment. These flanges let the user utilize the existing Caterpillar flange halves or new Gates Caterpillar flange halves. At the user's option, standard Code 62 flanges and halves can be used in place of Caterpillar flanges and halves. The standard Code 62 flange head thickness ranges between .305" and .495".

See Accessories for O-Rings.

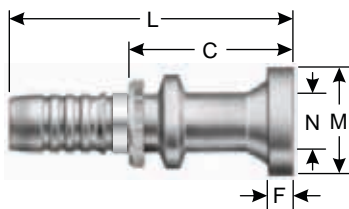

Descr.	Prod. No.	⊖		N		M		L		C		F		Std. Pack
		"	mm	"	"	mm	"	mm	"	mm	"	mm		
<b>STANDARD PACK</b>														
12GS-12FLC	7347-62445	3/4	19.1	3/4	1.63	41.4	5.71	145.0	3.70	94.0	.56	14.2	1	
12GS-16FLC	7347-62465	3/4	19.1	1	1.88	47.8	5.71	145.0	3.70	94.0	.56	14.2	1	
16GS-16FLC	7347-62555	1	25.4	1	1.88	47.8	6.10	155.0	3.87	98.2	.56	14.2	1	
16GS-20FLC	7347-62565	1	25.4	1 1/4	2.13	54.1	6.10	155.0	3.87	98.2	.56	14.2	1	
20GS-20FLC	7347-62645	1 1/4	31.7	1 1/4	2.13	54.1	7.36	187.0	4.56	115.9	.56	14.2	1	
20GS-24FLC	7347-62655	1 1/4	31.7	1 1/2	2.50	63.5	7.36	187.0	4.56	115.9	.56	14.2	1	
<b>BULK PACK</b>														
16GS-16FLCXBULK	7347-6255	1	25.4	1	1.88	47.8	6.10	155.0	3.87	98.2	.56	14.2	35	
16GS-20FLCXBULK	7347-6256	1	25.4	1 1/4	2.13	54.1	6.10	155.0	3.87	98.2	.56	14.2	25	
20GS-20FLCXBULK	7347-6264	1 1/4	31.7	1 1/4	2.13	54.1	7.36	187.0	4.56	115.9	.56	14.2	20	

EQUIPMENT

HOSE/CPLG. SELECTION

GLOBALSPIRAL COUPLINGS

PCM/PCS FERRULES

MEGACRIMP COUPLINGS

POWER CRIMP COUPLINGS

LOW PRESSURE COUPLINGS

POLARSEAL COUPLINGS

C14 COUPLINGS

PCTS THERMO-PLASTIC COUPLINGS

FIELD ATTACHABLE G1 & G2 COUPLINGS

FIELD ATTACHABLE C5 COUPLINGS

SURELOK AIR BRAKE COUPLINGS

QUICK DISCONNECT COUPLERS

NEW BALL VALVES

ACCESSORIES

EQUIPMENT AND PARTS





## Caterpillar Style O-Ring Flange - 22½° Bent Tube

Note: These FLC flanges are designed with a thicker flange head. The 0.56" flange dimension is frequently found on Caterpillar equipment. These flanges let the user utilize the existing Caterpillar flange halves or new Gates Caterpillar flange halves. At the user's option, standard Code 62 flanges and halves can be used in place of Caterpillar flanges and halves. The standard Code 62 flange head thickness ranges between .305" and .495".

See Accessories for O-Rings.

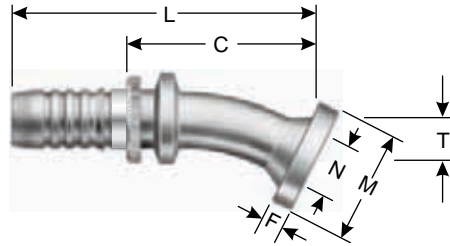

Descr.	Prod. No.	⊖		N	M		T		L		C		F		Std. Pack
		"	mm		"	"	mm	"	mm	"	mm	"	mm	"	
<b>STANDARD PACK</b>															
12GS-12FLC22-016	7347-63445	3/4	19.1	3/4	1.63	41.4	.63	16.0	5.63	143.0	3.62	92.0	.56	14.2	1
16GS-16FLC22-017	7347-63555	1	25.4	1	1.88	47.8	.67	17.0	6.02	153.0	3.78	95.9	.56	14.2	1
16GS-20FLC22-017	7347-63565	1	25.4	1 1/4	2.13	54.1	.67	17.0	6.02	153.0	3.78	95.9	.56	14.2	1
20GS-20FLC22-017	7347-63645	1 1/4	31.7	1 1/4	2.13	54.1	.67	17.0	7.28	185.0	4.48	113.9	.56	14.2	1
20GS-24FLC22-017	7347-63655	1 1/4	31.7	1 1/2	2.50	63.5	.67	17.0	7.28	185.0	4.48	113.9	.56	14.2	1

## Caterpillar Style O-Ring Flange - 30° Bent Tube

Note: These FLC flanges are designed with a thicker flange head. The 0.56" flange dimension is frequently found on Caterpillar equipment. These flanges let the user utilize the existing Caterpillar flange halves or new Gates Caterpillar flange halves. At the user's option, standard Code 62 flanges and halves can be used in place of Caterpillar flanges and halves. The standard Code 62 flange head thickness ranges between .305" and .495".

See Accessories for O-Rings.

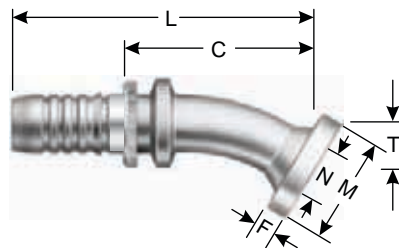

Descr.	Prod. No.	⊖		N	M		T		L		C		F		Std. Pack
		"	mm		"	"	mm	"	mm	"	mm	"	mm	"	
<b>STANDARD PACK</b>															
12GS-12FLC30-022	7347-64445	3/4	19.1	3/4	1.63	41.4	.87	22.0	5.51	140.0	3.50	89.0	.56	14.2	1
12GS-16FLC30-022	7347-64465	3/4	19.1	1	1.88	47.8	.87	22.0	5.55	141.0	3.54	90.0	.56	14.2	1
16GS-16FLC30-023	7347-64555	1	25.4	1	1.88	47.8	.91	23.0	5.94	151.0	3.69	93.7	.56	14.2	1
16GS-20FLC30-023	7347-64565	1	25.4	1 1/4	2.13	54.1	.91	23.0	5.94	151.0	3.69	93.7	.56	14.2	1
20GS-20FLC30-024	7347-64645	3/4	31.7	1 1/4	2.13	54.1	.94	24.0	7.20	183.0	4.41	111.9	.56	14.2	1
20GS-24FLC30-024	7347-64655	1 1/4	31.7	1 1/2	2.50	63.5	.94	24.0	7.20	183.0	4.41	111.9	.56	14.2	1



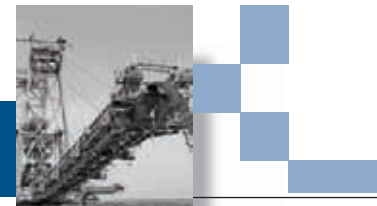

## Caterpillar Style O-Ring Flange - 45° Bent Tube

Note: These FLC flanges are designed with a thicker flange head. The 0.56" flange dimension is frequently found on Caterpillar equipment. These flanges let the user utilize the existing Caterpillar flange halves or new Gates Caterpillar flange halves. At the user's option, standard Code 62 flanges and halves can be used in place of Caterpillar flanges and halves. The standard Code 62 flange head thickness ranges between .305" and .495".

See Accessories for O-Rings.

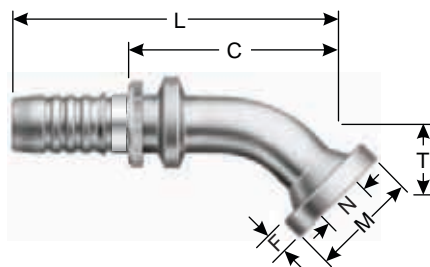

Descr.	Prod. No.	⊖		N	M		T		L		C		F		Std. Pack
		"	mm		"	"	mm	"	mm	"	mm	"	mm	"	
<b>STANDARD PACK</b>															
12GS-12FLC45-035	7347-65445	3/4	19.1	3/4	1.63	41.4	1.38	35.0	5.24	133.0	3.23	82.0	.56	14.2	1
12GS-12FLC45-066	7347-76425	3/4	19.1	3/4	1.63	41.4	2.60	66.0	6.50	165.0	4.49	114.0	.56	14.2	1
12GS-16FLC45-035	7347-65465	3/4	19.1	1	1.88	47.8	1.38	35.0	5.24	133.0	3.23	82.0	.56	14.2	1
16GS-16FLC45-037	7347-65555	1	25.4	1	1.88	47.8	1.46	37.0	5.63	143.0	3.40	86.3	.56	14.2	1
16GS-20FLC45-037	7347-65565	1	25.4	1 1/4	2.13	54.1	1.46	37.0	5.63	143.0	3.40	86.3	.56	14.2	1
20GS-20FLC45-037	7347-65645	1 1/4	31.7	1 1/4	2.13	54.1	1.46	37.0	6.93	176.0	4.13	104.9	.56	14.2	1
20GS-24FLC45-037	7347-65655	1 1/4	31.7	1 1/2	2.50	63.5	1.46	37.0	6.93	176.0	4.13	104.9	.56	14.2	1

## Caterpillar Style O-Ring Flange - 60° Bent Tube

Note: These FLC flanges are designed with a thicker flange head. The 0.56" flange dimension is frequently found on Caterpillar equipment. These flanges let the user utilize the existing Caterpillar flange halves or new Gates Caterpillar flange halves. At the user's option, standard Code 62 flanges and halves can be used in place of Caterpillar flanges and halves. The standard Code 62 flange head thickness ranges between .305" and .495".

See Accessories for O-Rings.

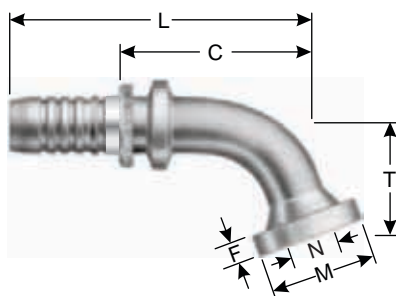

Descr.	Prod. No.	⊖		N	M		T		L		C		F		Std. Pack
		"	mm		"	"	mm	"	mm	"	mm	"	mm	"	
<b>STANDARD PACK</b>															
12GS-16FLC60-048	7347-66465	3/4	19.1	1	1.88	47.8	1.89	48.0	5.75	146.0	3.74	95.0	.56	14.2	1
16GS-16FLC60-050	7347-66555	1	25.4	1	1.88	47.8	1.97	50.0	6.42	163.0	4.17	106.0	.56	14.2	1
16GS-20FLC60-050	7347-66565	1	25.4	1 1/4	2.13	54.1	1.97	50.0	6.42	163.0	4.17	106.0	.56	14.2	1
20GS-20FLC60-052	7347-66645	1 1/4	31.7	1 1/4	2.13	54.1	2.05	52.0	7.80	198.0	5.00	126.9	.56	14.2	1
20GS-24FLC60-052	7347-66655	1 1/4	31.7	1 1/2	2.50	63.5	2.05	52.0	7.80	198.0	5.00	126.9	.56	14.2	1

EQUIPMENT
HOSE/CPLG. SELECTION
<b>GLOBAL SPIRAL COUPLINGS</b>
PCM/PCS FERRULES
MEGACRIMP COUPLINGS
POWER CRIMP COUPLINGS
LOW PRESSURE COUPLINGS
POLARSEAL COUPLINGS
C14 COUPLINGS
PCTS THERMO-PLASTIC COUPLINGS
FIELD ATTACHABLE G1 & G2 COUPLINGS
FIELD ATTACHABLE C5 COUPLINGS
SURELOK AIR BRAKE COUPLINGS
QUICK DISCONNECT COUPLERS
NEW BALL VALVES
ACCESSORIES
EQUIPMENT AND PARTS





# GlobalSpiral™ Couplings

## Caterpillar Style O-Ring Flange - 67½° Bent Tube

Note: These FLC flanges are designed with a thicker flange head. The 0.56" flange dimension is frequently found on Caterpillar equipment. These flanges let the user utilize the existing Caterpillar flange halves or new Gates Caterpillar flange halves. At the user's option, standard Code 62 flanges and halves can be used in place of Caterpillar flanges and halves. The standard Code 62 flange head thickness ranges between .305" and .495".

See Accessories for O-Rings.

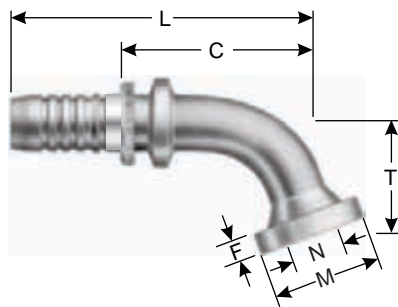

Descr.	Prod. No.	⊖		N	M		T		L		C		F		Std. Pack
		"	mm		"	"	mm	"	mm	"	mm	"	mm	"	
<b>STANDARD PACK</b>															
16GS-16FLC67-057	7347-67555	1	25.4	1	1.88	47.8	2.24	57.0	6.14	156.0	3.90	99.0	.56	14.2	1
16GS-20FLC67-057	7347-67565	1	25.4	1 1/4	2.13	54.1	2.24	57.0	6.14	156.0	3.90	99.0	.56	14.2	1
20GS-20FLC67-059	7347-67645	1 1/4	31.7	1 1/4	2.13	54.1	2.32	59.0	7.52	191.0	4.72	119.9	.56	14.2	1
20GS-24FLC67-059	7347-67655	1 1/4	31.7	1 1/2	2.50	63.5	2.32	59.0	7.52	191.0	4.72	119.9	.56	14.2	1

## Caterpillar Style O-Ring Flange - 90° Short Bent Tube

Note: These FLC flanges are designed with a thicker flange head. The 0.56" flange dimension is frequently found on Caterpillar equipment. These flanges let the user utilize the existing Caterpillar flange halves or new Gates Caterpillar flange halves. At the user's option, standard Code 62 flanges and halves can be used in place of Caterpillar flanges and halves. The standard Code 62 flange head thickness ranges between .305" and .495".

See Accessories for O-Rings.

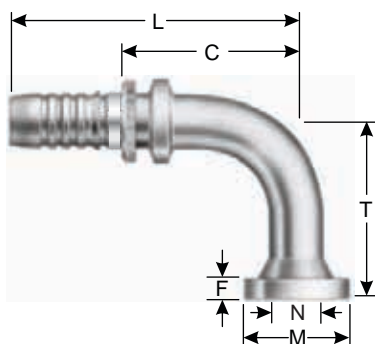

Descr.	Prod. No.	⊖		N	M		T		L		C		F		Std. Pack
		"	mm		"	"	mm	"	mm	"	mm	"	mm	"	
<b>STANDARD PACK</b>															
12GS-12FLC90-068	7347-73945	3/4	19.1	3/4	1.88	41.3	2.68	68.0	4.92	125.0	2.91	74.0	.38	9.5	1
12GS-16FLC90-068	7347-73955	3/4	19.1	1	1.88	47.8	2.68	68.0	4.61	117.0	2.60	66.0	.56	14.2	1
16GS-16FLC90-074	7347-68555	1	25.4	1	1.88	47.8	2.91	74.0	5.16	131.0	2.92	74.1	.56	14.2	1
16GS-20FLC90-074	7347-68565	1	25.4	1 1/4	2.13	54.1	2.91	74.0	5.16	131.0	2.92	74.1	.56	14.2	1
20GS-20FLC90-077	7347-68645	1 1/4	31.7	1 1/4	2.13	54.1	3.03	77.0	6.54	166.0	3.74	94.9	.56	14.2	1





## Caterpillar Style O-Ring Flange - 90° Short Bent Tube - Cont'd

Descr.	Prod. No.	⊖		N	M		T		L		C		F		Std. Pack
		"	mm		"	"	mm	"	mm	"	mm	"	mm	"	
20GS-24FLC90-077	7347-68655	1 1/4	31.7	1 1/2	2.50	63.5	3.03	77.0	6.54	166.0	3.74	94.9	.56	14.2	1
<b>BULK PACK</b>															
12GS-12FLC90-068XBULK	7347-7394	3/4	19.1	3/4	1.88	41.3	2.68	68.0	4.92	125.0	2.91	74.0	.38	9.5	50
12GS-16FLC90-068XBULK	7347-7395	3/4	19.1	1	1.88	47.8	2.68	68.0	4.61	117.0	2.60	66.0	.56	14.2	30
16GS-16FLC90-074XBULK	7347-6855	1	25.4	1	1.88	47.8	2.91	74.0	5.16	131.0	2.92	74.1	.56	14.2	25
16GS-20FLC90-074XBULK	7347-6856	1	25.4	1 1/4	2.13	54.1	2.91	74.0	5.16	131.0	2.92	74.1	.56	14.2	25
20GS-20FLC90-077XBULK	7347-6864	1 1/4	31.7	1 1/4	2.13	54.1	3.03	77.0	6.54	166.0	3.74	94.9	.56	14.2	18

## Caterpillar Style O-Ring Flange - 90° Medium Bent Tube

Note: These FLC flanges are designed with a thicker flange head. The 0.56" flange dimension is frequently found on Caterpillar equipment. These flanges let the user utilize the existing Caterpillar flange halves or new Gates Caterpillar flange halves. At the user's option, standard Code 62 flanges and halves can be used in place of Caterpillar flanges and halves. The standard Code 62 flange head thickness ranges between .305" and .495".  
See Accessories for O-Rings.

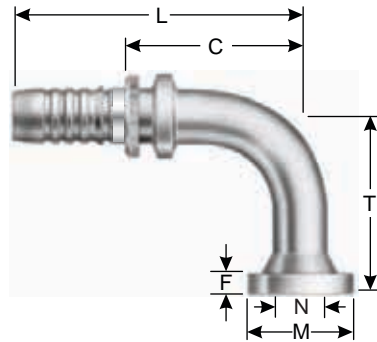

Descr.	Prod. No.	⊖		N	M		T		L		C		F		Std. Pack
		"	mm		"	"	mm	"	mm	"	mm	"	mm	"	
<b>STANDARD PACK</b>															
12GS-12FLC90-128	7347-76015	3/4	19.1	3/4	1.63	41.4	5.04	128.0	4.61	117.0	2.60	66.0	.56	14.2	1
16GS-16FLC90-132	7347-73035	1	25.4	1	1.88	47.8	5.20	132.0	5.16	131.0	2.92	74.1	.56	14.2	1

## Hose Length Extender

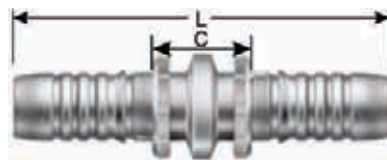

Descr.	Prod. No.	⊖		L		C		Std. Pack
		"	mm	"	mm	"	mm	
<b>STANDARD PACK</b>								
8GS-8HLE	7347-73265	1/2	12.7	3.70	94.0	.75	19.1	1
12GS-12HLE	7347-76815	3/4	19.0	4.80	121.9	.78	19.9	1
16GS-16HLE	7347-76625	1	25.4	5.43	138.0	—	24.4	1
20GS-20HLE	7347-78585	1 1/4	31.7	6.77	172.0	1.17	29.8	1

EQUIPMENT

HOSE/CPLG. SELECTION

GLOBALSPIRAL COUPLINGS

PCM/PCS FERRULES

MEGACRIMP COUPLINGS

POWER CRIMP COUPLINGS

LOW PRESSURE COUPLINGS

POLARSEAL COUPLINGS

C14 COUPLINGS

PCTS THERMO-PLASTIC COUPLINGS

FIELD ATTACHABLE G1 &amp; G2 COUPLINGS

FIELD ATTACHABLE C5 COUPLINGS

SURELOK AIR BRAKE COUPLINGS

QUICK DISCONNECT COUPLERS

NEW BALL VALVES

ACCESSORIES

EQUIPMENT AND PARTS





# GlobalSpiral™ Couplings

EQUIPMENT

HOSE/CPLG. SELECTION

GLOBALSPIRAL COUPLINGS

PCM/PCS FERRULES

MEGACRIMP COUPLINGS

POWER CRIMP COUPLINGS

LOW PRESSURE COUPLINGS

POLARSEAL COUPLINGS

C14 COUPLINGS

PCTS THERMO-PLASTIC COUPLINGS

FIELD ATTACHABLE G1 & G2 COUPLINGS

FIELD ATTACHABLE C5 COUPLINGS

SURELOK AIR BRAKE COUPLINGS

QUICK DISCONNECT COUPLERS

NEW BALL VALVES

ACCESSORIES

EQUIPMENT AND PARTS

## Hose Length Extender - 45° Bent Tube

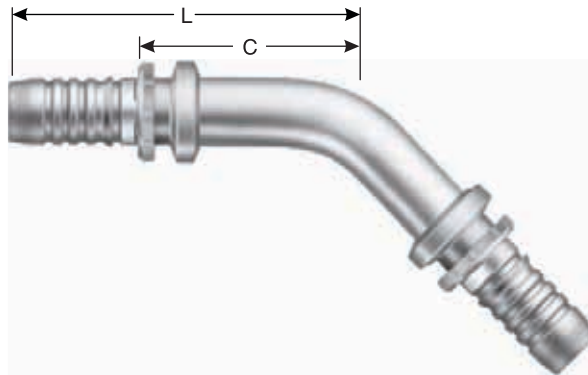

Descr.	Prod. No.	⊖		L		C		Std. Pack
		"	mm	"	mm	"	mm	
<b>STANDARD PACK</b>								
20GS-20HLE45-103	7347-78895	1 1/4	31.7	9.80	249.0	6.19	157.2	1

## Hose Length Extender - 90° Bent Tube

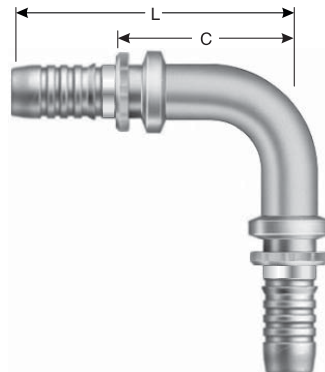

Descr.	Prod. No.	⊖		L		C		Std. Pack
		"	mm	"	mm	"	mm	
<b>STANDARD PACK</b>								
8GS-8HLE90-086	7347-73195	1/2	12.7	3.39	86.0	1.91	48.5	1
12GS-12HLE90-112	7347-73965	3/4	19.1	4.39	111.5	2.38	60.5	1
16GS-16HLE90-127	7347-73705	1	25.4	5.00	127.0	2.76	70.2	1
20GS-20HLE90-155	7347-76705	1 1/4	31.7	6.10	155.0	3.30	83.9	1





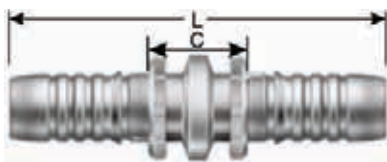

## Hose Length Extender Caterpillar

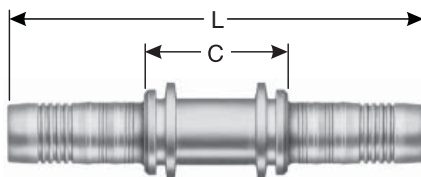

Descr.	Prod. No.	⊖		L		C		Std. Pack
		"	mm	"	mm	"	mm	
<b>STANDARD PACK</b>								
12GS-12HLEC	7347-76405	3/4	19.1	6.42	163.0	2.40	61.0	1
16GS-16HLEC	7347-76395	1	25.4	7.09	180.0	2.61	66.4	1

## Hose Length Extender for Caterpillar with Clamping Area



Descr.	Prod. No.	⊖		L	C	Std. Pack
		"		"	"	
<b>STANDARD PACK</b>						
24GSLHL-24HLEC	7341-02645	1 1/2	1 1/2	10.66	3.18	1

## Male DIN 24° Cone - Light Series

Do not use at a pressure above DIN Light ratings.  
Nut Hex per ISO Draft International Standards 12151-2.

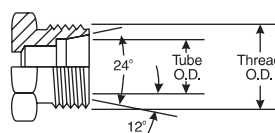
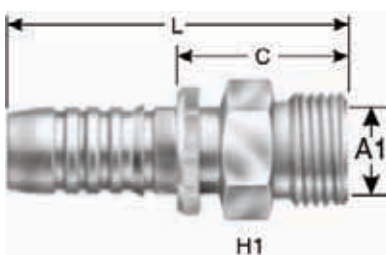

Descr.	Prod. No.	⊖			H1	H2	L		C		A1	Std. Pack
		"	mm		"	"	"	mm	"	mm	mm	
<b>STANDARD PACK</b>												
8GS-15MDL	7347-90625	1/2	12.7	M22X1.5	24.00	—	2.48	63.0	1.00	25.5	12.0	1
12GS-22MDL	7347-93565	3/4	19.1	M30X2.0	32.00	—	3.13	79.5	1.12	28.5	19.0	1
16GS-28MDL	7347-91495	1	25.4	M36X2.0	41.00	—	3.54	90.0	1.31	33.2	24.0	1

EQUIPMENT

HOSE/CPLG. SELECTION

GLOBALSPIRAL COUPLINGS

PCM/PCS FERRULES

MEGACRIMP COUPLINGS

POWER CRIMP COUPLINGS

LOW PRESSURE COUPLINGS

POLARSEAL COUPLINGS

C14 COUPLINGS

PCTS THERMO-PLASTIC COUPLINGS

FIELD ATTACHABLE G1 & G2 COUPLINGS

FIELD ATTACHABLE C5 COUPLINGS

SURELOK AIR BRAKE COUPLINGS

QUICK DISCONNECT COUPLERS

NEW BALL VALVES

ACCESSORIES

EQUIPMENT AND PARTS



# GlobalSpiral™ Couplings

## Female DIN 24° Cone Swivel - Light Series with O-Ring

Do not use at a pressure above DIN Light ratings.  
Nut Hex per ISO Draft International Standards 12151-2.

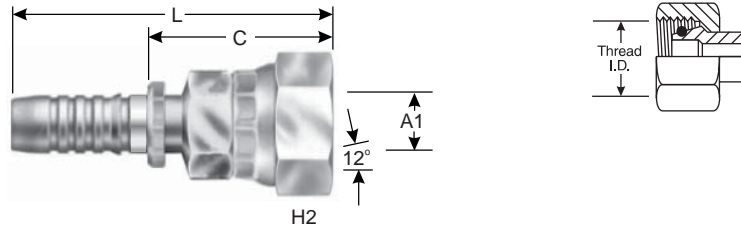

Descr.	Prod. No.	⊖		🌀	H1	H2	L		C		A1	Std. Pack
		"	mm		mm	mm	"	mm	"	mm	mm	
<b>STANDARD PACK</b>												
6GS-12FDLORX	7347-92815	3/8	9.5	M18X1.5	—	22.0	2.87	73.0	1.46	37.2	12.0	1
8GS-15FDLORX	7347-90595	1/2	12.7	M22X1.5	—	22.0	2.87	73.0	1.40	35.5	15.0	1
10GS-18FDLORX	7347-92105	5/8	15.8	M26X1.5	—	32.0	3.61	91.8	1.63	41.5	18.0	1
12GS-22FDLORX	7347-92125	3/4	19.1	M30X2.0	—	36.0	3.82	97.0	1.81	46.0	22.0	1
12GS-28FDLORX	7347-92165	3/4	19.1	M36X2.0	—	41.0	3.90	99.0	1.89	48.0	28.0	1
16GS-28FDLORX	7347-90795	1	25.4	M36X2.0	—	41.0	4.13	105.0	1.91	48.6	28.0	1
<b>BULK PACK</b>												
10GS-18FDLORX XBULK	7347-9210	5/8	15.8	M26X1.5	—	32.0	3.61	91.8	1.63	41.5	18.0	120

## Female DIN 24° Cone Swivel - Light Series with O-Ring - 45° Bent Tube

Do not use at a pressure above DIN Light ratings.  
Nut Hex per ISO Draft International Standards 12151-2.

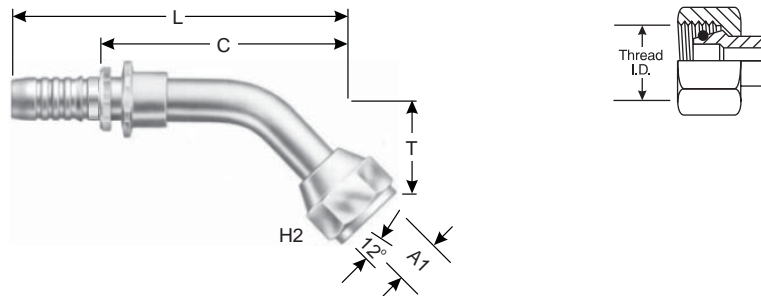

Descr.	Prod. No.	⊖		🌀	H1	H2	T		L		C		A1	Std. Pack
		"	mm		mm	mm	"	mm	"	mm	"	mm	mm	
<b>STANDARD PACK</b>														
12GS-22FDLORX45	7347-92525	3/4	19.1	M30X2.0	—	36.0	1.17	29.8	5.35	135.8	3.34	84.8	22.0	1



## Female DIN 24° Cone Swivel - Light Series with O-Ring - 90° Bent Tube

Do not use at a pressure above DIN Light ratings.  
Nut Hex per ISO Draft International Standards 12151-2.

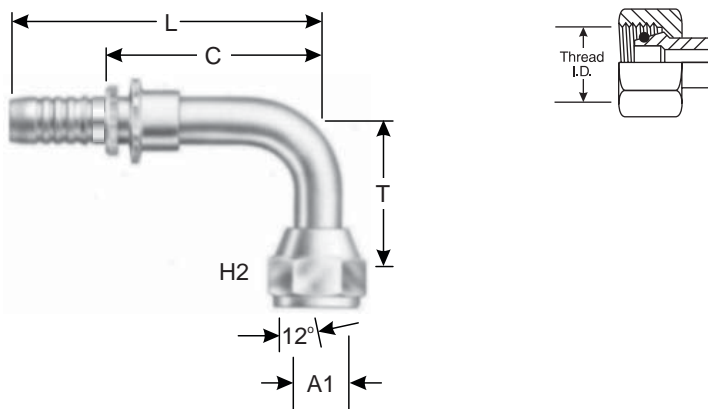

Descr.	Prod. No.	⊖		🌀	H1	H2	T		L		C		A1	Std. Pack
		"	mm		mm	mm	"	mm	"	mm	"	mm	mm	
<b>STANDARD PACK</b>														
10GS-18FDLORX90	7347-92515	5/8	15.8	M26X1.5	—	32.0	2.03	51.5	4.47	113.5	2.49	63.2	18.0	1
12GS-22FDLORX90M	7347-92135	3/4	19.1	M30X2.0	—	36.0	2.44	62.0	4.86	123.5	2.86	72.5	22.0	1
16GS-28FDLORX90M	7347-90765	1	25.4	M36X2.0	—	41.0	2.76	70.0	5.82	147.7	2.71	68.7	28.0	1
<b>BULK PACK</b>														
10GS-18FDLORX90XBULK	7347-9251	5/8	15.8	M26X1.5	—	32.0	2.03	51.5	4.47	113.5	2.49	63.2	18.0	75

## Male DIN 24° Cone - Heavy Series

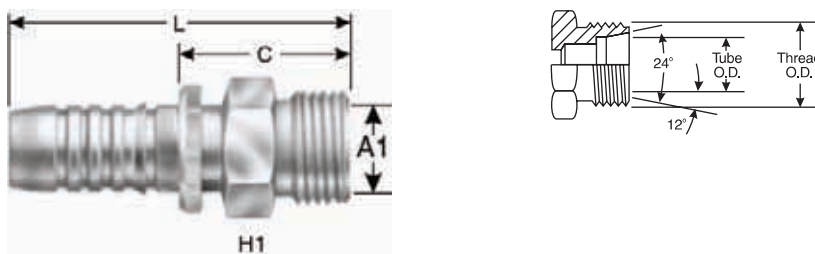

Descr.	Prod. No.	⊖		🌀	H1	H2	L		C		A1	Std. Pack
		"	mm		mm	mm	"	mm	"	mm	mm	
<b>STANDARD PACK</b>												
6GS-12MDH	7347-01785	3/8	9.5	M20X1.5	22.0	—	2.51	63.7	1.10	27.9	12.0	1
8GS-16MDH	7347-91325	1/2	12.7	M24X1.5	27.0	—	1.17	67.5	1.18	30.0	16.0	1
12GS-20MDH	7347-92255	3/4	19.1	M30X2.0	32.0	—	3.35	85.0	1.34	34.0	20.0	1
12GS-25MDH	7347-92265	3/4	19.1	M36X2.0	41.0	—	3.50	89.0	1.50	38.0	25.0	1
16GS-25MDH	7347-91505	1	25.4	M30X2.0	41.0	—	3.82	97.0	1.58	40.2	25.0	1
16GS-30MDH	7347-91515	1	25.4	M42X2.0	46.0	—	3.90	99.0	1.66	42.2	30.0	1
20GS-38MDH	7347-93295	1 1/4	31.7	M52X2.0	55.0	—	4.84	123.0	2.04	51.9	38.0	1

EQUIPMENT
HOSE/CPLG. SELECTION
<b>GLOBALSPIRAL COUPLINGS</b>
PCM/PCS FERRULES
MEGACRIMP COUPLINGS
POWER CRIMP COUPLINGS
LOW PRESSURE COUPLINGS
POLARSEAL COUPLINGS
C14 COUPLINGS
PCTS THERMO-PLASTIC COUPLINGS
FIELD ATTACHABLE G1 & G2 COUPLINGS
FIELD ATTACHABLE C5 COUPLINGS
SURELOK AIR BRAKE COUPLINGS
QUICK DISCONNECT COUPLERS
NEW BALL VALVES
ACCESSORIES
EQUIPMENT AND PARTS





# GlobalSpiral™ Couplings

EQUIPMENT
HOSE/CPLG. SELECTION
GLOBALSPIRAL COUPLINGS
PCM/PCS FERRULES
MEGACRIMP COUPLINGS
POWER CRIMP COUPLINGS
LOW PRESSURE COUPLINGS
POLARSEAL COUPLINGS
C14 COUPLINGS
PCTS THERMO-PLASTIC COUPLINGS
FIELD ATTACHABLE G1 & G2 COUPLINGS
FIELD ATTACHABLE C5 COUPLINGS
SURELOK AIR BRAKE COUPLINGS
QUICK DISCONNECT COUPLERS
NEW BALL VALVES
ACCESSORIES
EQUIPMENT AND PARTS

## Female DIN 24° Cone Swivel - Heavy Series with O-Ring

Nut Hex per ISO Draft International Standards 12151-2.

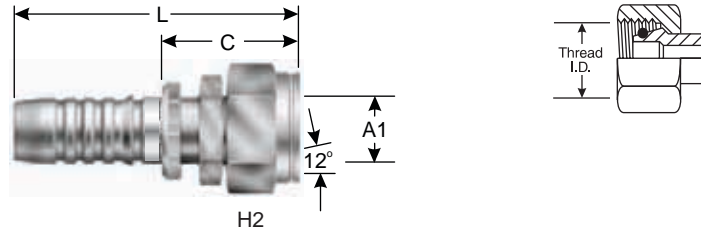

Descr.	Prod. No.	⊖		🌀	H1	H2	L		C		A1	Std. Pack
		"	mm		mm	mm	"	mm	"	mm	mm	
<b>STANDARD PACK</b>												
6GS-12FDHORX	7347-92645	3/8	9.5	M36X2.0	—	24.0	2.87	73.0	1.46	37.2	12.0	1
6GS-14FDHORX	7347-92085	3/8	9.5	M22X1.5	—	27.0	2.97	75.5	1.56	39.7	14.0	1
8GS-14FDHORX	7347-92095	1/2	12.7	M22X1.5	—	27.0	3.01	76.5	1.53	38.9	14.0	1
8GS-16FDHORX	7347-91335	1/2	12.7	M24X1.5	—	30.0	3.11	79.0	1.63	41.5	16.0	1
10GS-20FDHORX	7347-92115	5/8	15.8	M30X2.0	—	36.0	3.94	100.0	1.96	49.7	20.0	1
10GS-25FDHORX	7347-93425	5/8	15.8	M36X2.0	—	46.0	4.09	104.0	2.11	53.7	25.0	1
12GS-20FDHORX	7347-92145	3/4	19.1	M30X2.0	—	36.0	4.06	103.0	2.05	52.0	20.0	1
12GS-25FDHORX	7347-92155	3/4	19.1	M36X2.0	—	46.0	4.23	107.4	2.22	56.4	25.0	1
16GS-25FDHORX	7347-91535	1	25.4	M36X2.0	—	46.0	4.57	116.0	2.35	59.6	25.0	1
16GS-30FDHORX	7347-90805	1	25.4	M42X2.0	—	50.0	4.65	118.0	2.43	61.6	30.0	1
20GS-38FDHORX	7347-93305	1 1/4	31.7	M52X2.0	—	60.0	5.71	145.0	2.91	73.9	38.0	1
<b>BULK PACK</b>												
12GS-25FDHORX XBULK	7347-9215	3/4	19.1	M36X2.0	—	46.0	4.23	107.4	2.22	56.4	25.0	45
16GS-25FDHORX XBULK	7347-9153	1	25.4	M36X2.0	—	46.0	4.57	116.0	2.35	59.6	25.0	25
16GS-30FDHORX XBULK	7347-9080	1	25.4	M42X2.0	—	50.0	4.65	118.0	2.43	61.6	30.0	35
20GS-38FDHORX XBULK	7347-9330	1 1/4	31.7	M52X2.0	—	60.0	5.71	145.0	2.91	73.9	38.0	20

## Female DIN 24° Cone Swivel - Heavy Series with O-Ring - 45° Bent Tube

Nut Hex per ISO Draft International Standards 12151-2.

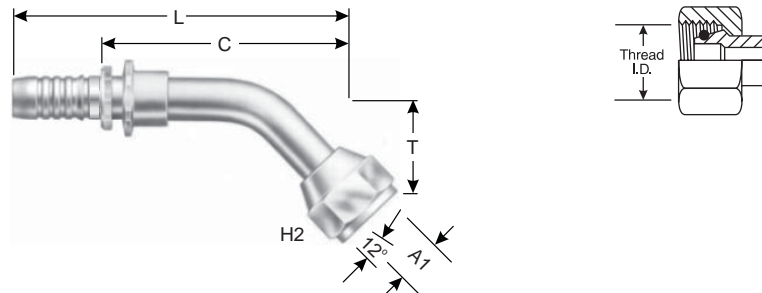

Descr.	Prod. No.	⊖		🌀	H1	H2	T	L		C		A1	Std. Pack	
		"	mm		mm	mm	"	mm	"	mm	"	mm		
<b>STANDARD PACK</b>														
8GS-16FDHORX45M	7347-91345	1/2	12.7	M24X1.5	—	30.0	.85	21.6	3.70	94.1	2.23	56.7	16.0	1
10GS-20FDHORX45	7347-92325	5/8	15.8	M30X2.0	—	36.0	.98	24.9	4.79	121.6	2.81	71.3	20.0	1
12GS-20FDHORX45	7347-93285	3/4	19.1	M30X2.0	—	36.0	1.17	29.8	6.33	160.9	4.33	109.9	20.0	1
12GS-25FDHORX45M	7347-92175	3/4	19.1	M36X2.0	—	46.0	1.23	31.2	5.31	134.8	3.40	86.3	25.0	1







## Female DIN 24° Cone Swivel - Heavy Series with O-Ring - 45° Bent Tube - Cont'd

Descr.	Prod. No.	⊖			H1	H2	T		L		C		A1	Std. Pack
		"	mm		mm	mm	"	mm	"	mm	"	mm	mm	
16GS-25FDHORX45M	7347-91545	1	25.4	M36X2.0	—	46.0	1.38	35.1	3.90	99.0	1.66	42.2	25.0	1
16GS-30FDHORX45	7347-91565	1	25.4	M42X2.0	—	50.0	1.38	35.1	6.29	159.7	4.07	103.3	30.0	1
20GS-38FDHORX45M	7347-93415	1 1/4	31.7	M52X2.0	—	60.0	1.67	42.5	7.72	196.0	4.92	124.9	38.0	1

## Female DIN 24° Cone Swivel - Heavy Series with O-Ring - 90° Bent Tube

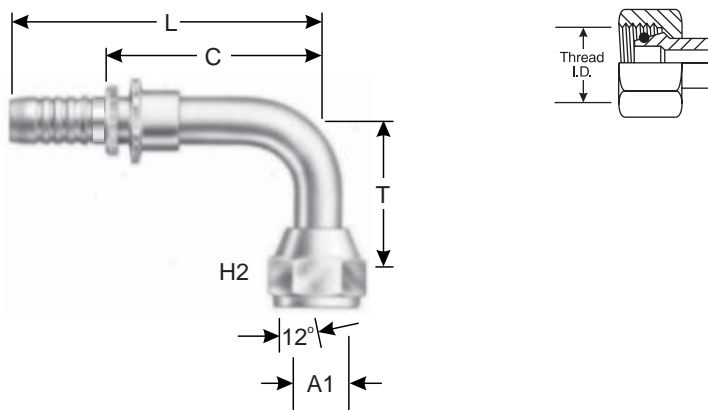
Nut Hex per ISO Draft International Standards 12151-2.



Descr.	Prod. No.	⊖			H1	H2	T		L		C		A1	Std. Pack
		"	mm		mm	mm	"	mm	"	mm	"	mm	mm	
<b>STANDARD PACK</b>														
8GS-16FDHORX90M	7347-91485	1/2	12.7	M24X1.5	—	30.0	1.73	44.0	3.39	86.0	1.91	48.5	16.0	1
10GS-20FDHORX90M	7347-92335	5/8	15.8	M30X2.0	—	36.0	2.01	51.0	4.43	112.5	2.45	62.2	20.0	1
12GS-20FDHORX90M	7347-92185	3/4	19.1	M30X2.0	—	36.0	2.44	62.0	4.86	123.5	2.85	72.5	20.0	1
12GS-25FDHORX90M	7347-92195	3/4	19.1	M36X2.0	—	46.0	2.52	64.0	4.86	123.5	2.85	72.5	25.0	1
16GS-25FDHORX90	7347-91555	1	25.4	M36X2.0	—	46.0	2.99	76.0	5.94	151.0	3.72	94.6	25.0	1
16GS-30FDHORX90M	7347-90775	1	25.4	M42X2.0	—	50.0	2.99	76.0	5.81	147.7	3.59	91.3	30.0	1
20GS-38FDHORX90M	7347-93315	1 1/4	31.7	M52X2.0	—	60.0	3.43	87.0	7.11	180.5	4.31	109.4	38.0	1
<b>BULK PACK</b>														
20GS-38FDHORX90MXBULK	7347-9331	1 1/4	31.7	M52X2.0	—	60.0	3.43	87.0	7.11	180.5	4.31	109.4	38.0	10

- EQUIPMENT
- HOSE/CPLG. SELECTION
- GLOBALSPIRAL COUPLINGS**
- PCM/PCS FERRULES
- MEGACRIMP COUPLINGS
- POWER CRIMP COUPLINGS
- LOW PRESSURE COUPLINGS
- POLARSEAL COUPLINGS
- C14 COUPLINGS
- PCTS THERMO-PLASTIC COUPLINGS
- FIELD ATTACHABLE G1 & G2 COUPLINGS
- FIELD ATTACHABLE C5 COUPLINGS
- SURELOK AIR BRAKE COUPLINGS
- QUICK DISCONNECT COUPLERS
- NEW BALL VALVES
- ACCESSORIES
- EQUIPMENT AND PARTS





# GlobalSpiral™ Couplings

EQUIPMENT

HOSE/CPLG. SELECTION

GLOBALSPIRAL COUPLINGS

PCM/PCS FERRULES

MEGACRIMP COUPLINGS

POWER CRIMP COUPLINGS

LOW PRESSURE COUPLINGS

POLARSEAL COUPLINGS

C14 COUPLINGS

PCTS THERMO-PLASTIC COUPLINGS

FIELD ATTACHABLE G1 & G2 COUPLINGS

FIELD ATTACHABLE C5 COUPLINGS

SURELOK AIR BRAKE COUPLINGS

QUICK DISCONNECT COUPLERS

NEW BALL VALVES

ACCESSORIES

EQUIPMENT AND PARTS

## Male Kobelco Style

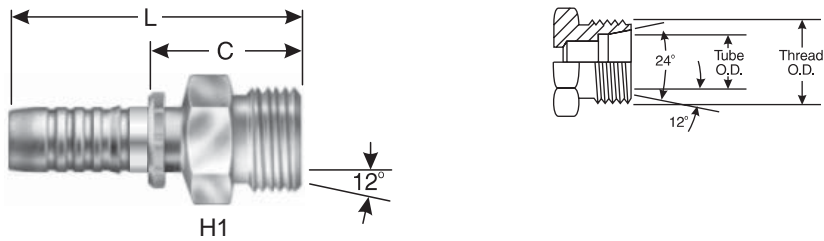

Descr.	Prod. No.	⊖			H1	H2	L		C		Std. Pack
		"	mm		mm	mm	"	mm	"	mm	
<b>STANDARD PACK</b>											
12GS-22MKB	7347-73665	3/4	19.1	M30X2.0	36.0	—	3.35	85.0	1.34	34.0	1
12GS-28MKB	7347-73675	3/4	19.1	M36X1.5	41.0	—	3.62	92.0	1.61	41.0	1
16GS-28MKB	7347-73095	1	25.4	M36X1.5	50.0	—	3.98	101.0	1.74	44.2	1
16GS-35MKB	7347-73025	1	25.4	M45X1.5	50.0	—	3.74	95.0	1.50	38.1	1

## Male British Standard Pipe Parallel

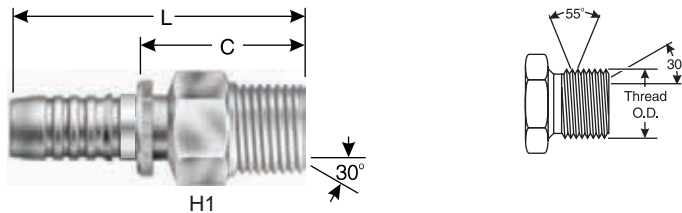

Descr.	Prod. No.	⊖			H1	H2	L		C		Std. Pack
		"	mm		mm	mm	"	mm	"	mm	
<b>STANDARD PACK</b>											
6GS-6MBSPP	7347-01775	3/8	9.5	3/8-19	22.0	—	2.48	63.0	1.07	27.2	1
8GS-8MBSPP	7347-91365	1/2	12.7	1/2-14	27.0	—	2.66	67.5	1.81	30.0	1
12GS-12MBSPP	7347-92205	3/4	19.1	3/4-14	32.0	—	3.35	85.0	1.37	34.7	1
16GS-16MBSPP	7347-90825	1	25.4	1-11	41.0	—	3.86	98.0	1.62	41.2	1
20GS-20MBSPP	7347-93365	1 1/4	31.7	1 1/4-11	50.0	—	4.65	118.0	1.85	46.9	1





## Female British Standard Parallel Pipe O-Ring Swivel

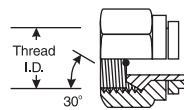
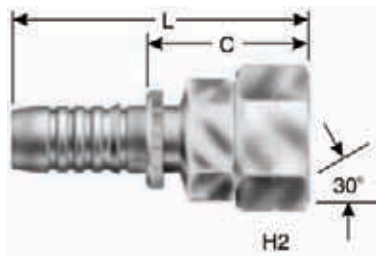

Descr.	Prod. No.	⊖		🌀	H1	H2	L		C		Std. Pack
		"	mm		mm	mm	"	mm	"	mm	
<b>STANDARD PACK</b>											
6GS-6FBSPORX	7347-92235	3/8	9.5	3/8-19	—	22.0	2.34	59.4	.93	23.5	1
8GS-8FBSPORX	7347-91405	1/2	12.7	1/2-14	—	27.0	2.40	61.0	.93	23.5	1
12GS-12FBSPORX	7347-93995	3/4	19.1	3/4-14	—	32.0	3.41	86.5	1.40	35.5	1
12GS-16FBSPORX	7347-92585	3/4	19.1	1-11	—	41.0	3.74	86.6	1.40	35.6	1
16GS-16FBSPORX	7347-90815	1	25.4	1-11	—	41.0	3.74	95.0	1.52	38.6	1
20GS-20FBSPORX	7347-93375	1 1/4	31.7	1 1/4-11	—	50.0	4.59	116.5	1.79	45.4	1
<b>BULK PACK</b>											
12GS-12FBSPORX XBULK	7347-93999	3/4	19.1	3/4-14	—	32.0	3.41	86.5	1.40	35.5	50
16GS-16FBSPORX XBULK	7347-9081	1	25.4	1-11	—	41.0	3.74	95.0	1.52	38.6	40

## Female British Standard Parallel Pipe O-Ring Swivel - 45° Bent Tube

S, M and L Drops and Hex per ISO Working Draft 12151-6.

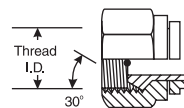
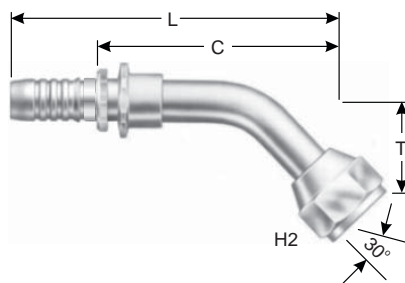

Descr.	Prod. No.	⊖		🌀	H1	H2	T		L		C		Std. Pack
		"	mm		mm	mm	"	mm	"	mm	"	mm	
<b>STANDARD PACK</b>													
6GS-6FBSPORX45M	7347-92345	3/8	9.5	3/8-19	—	22.0	.61	15.4	3.27	83.1	1.86	47.3	1
8GS-8FBSPORX45M	7347-91415	1/2	12.7	1/2-14	—	27.0	.67	17.0	3.60	91.5	2.13	54.1	1
12GS-12FBSPORX45M	7347-92245	3/4	19.1	3/4-14	—	32.0	1.11	28.3	5.29	134.4	3.28	83.4	1
16GS-16FBSPORX45M	7347-92275	1	25.4	1-11	—	41.0	1.22	30.9	6.12	155.5	3.90	99.1	1
20GS-20FBSPORX45M	7347-93395	1 1/4	31.7	1 1/4-11	—	50.0	1.48	37.5	7.52	191.1	4.72	119.9	1
<b>BULK PACK</b>													
8GS-8FBSPORX45MXBULK	7347-9141	1/2	12.7	1/2-14	—	27.0	.67	17.0	3.60	91.5	2.13	54.1	100
12GS-12FBSPORX45MXBULK	7347-9224	3/4	19.1	3/4-14	—	32.0	1.11	28.3	5.29	134.4	3.28	83.4	40



EQUIPMENT

HOSE/CPLG. SELECTION

GLOBALSPIRAL COUPLINGS

PCM/PCS FERRULES

MEGACRIMP COUPLINGS

POWER CRIMP COUPLINGS

LOW PRESSURE COUPLINGS

POLARSEAL COUPLINGS

C14 COUPLINGS

PCTS THERMO-PLASTIC COUPLINGS

FIELD ATTACHABLE G1 & G2 COUPLINGS

FIELD ATTACHABLE C5 COUPLINGS

SURELOK AIR BRAKE COUPLINGS

QUICK DISCONNECT COUPLERS

NEW BALL VALVES

ACCESSORIES

EQUIPMENT AND PARTS

## Female British Standard Parallel Pipe O-Ring Swivel - 90° Bent Tube

S, M and L Drops and Hex per ISO Working Draft 12151-6.

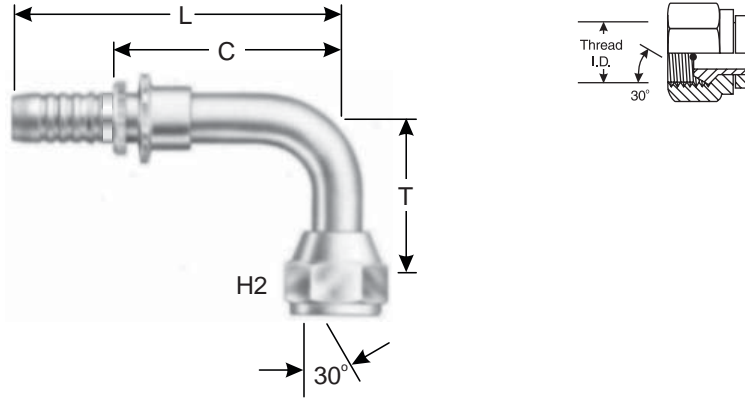

Descr.	Prod. No.	⊖		🌀	H1	H2	T		L		C		Std. Pack
		"	mm		mm	mm	"	mm	"	mm	"	mm	
<b>STANDARD PACK</b>													
6GS-6FBSPORX90M	7347-92355	3/8	9.5	3/8-19	—	22.0	1.26	32.0	3.07	78.0	1.66	42.2	1
8GS-8FBSPORX90M	7347-91425	1/2	12.7	1/2-14	—	27.0	1.48	37.0	3.46	88.0	1.99	50.5	1
12GS-12FBSPORX90M	7347-92225	3/4	19.1	3/4-14	—	32.0	2.36	60.0	4.86	123.5	2.85	72.5	1
16GS-16FBSPORX90M	7347-90785	1	25.4	1-11	—	41.0	2.76	70.0	5.81	147.7	3.59	91.3	1
20GS-20FBSPORX90M	7347-93405	1 1/4	31.7	1 1/4-11	—	50.0	3.15	80.0	7.11	180.5	4.31	109.4	1
<b>BULK PACK</b>													
8GS-8FBSPORX90MXBULK	7347-9142	1/2	12.7	1/2-14	—	27.0	1.48	37.0	3.46	88.0	1.99	50.5	100

## Female British Standard Pipe Parallel O-Ring Swivel - 90° Block

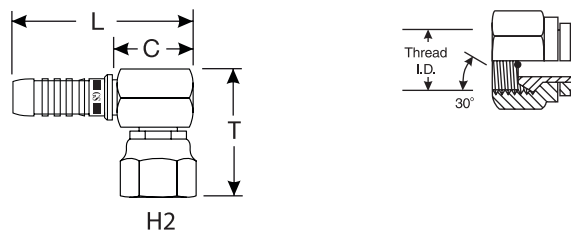

Descr.	Prod. No.	⊖		🌀	H1	H2	T		L		C		Std. Pack
		"	mm		mm	mm	"	mm	"	mm	"	mm	
<b>STANDARD PACK</b>													
12GS-12FBSPORX90BL	7347-93955	3/4	19.1	3/4-14	—	32.0	1.35	34.2	3.07	78.0	1.06	27.0	1



## Female French GAZ (Poclain) 24° High Pressure Flange

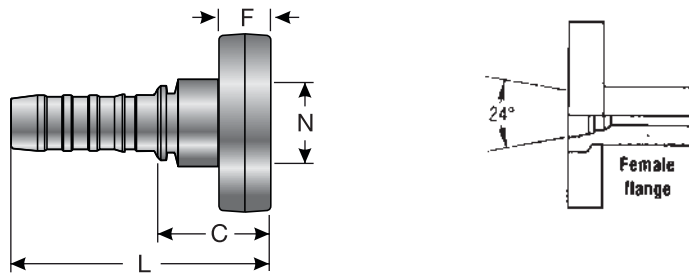

Descr.	Prod. No.	⊖		N	L		C		F		Std. Pack
		"	mm		"	mm	"	mm	"	mm	
<b>STANDARD PACK</b>											
8GS-17FPFL	7347-93215	1/2	12.7	17	2.72	69.0	1.24	31.5	.56	14.2	1
10GS-21FPFL	7347-92995	5/8	15.8	21	3.35	85.0	1.37	34.7	.56	14.2	1
12GS-27FPFL	7347-93065	3/4	19.1	27	3.58	91.0	1.57	40.0	.56	14.2	1
16GS-34FPFL	7347-93165	1	25.4	34	4.02	102.0	1.78	45.2	.56	14.2	1
20GS-42FPFL	7347-93465	1 1/4	31.7	42	5.24	133.0	2.44	61.9	.56	14.2	1

## Male French GAZ (Poclain) 24° High Pressure Flange

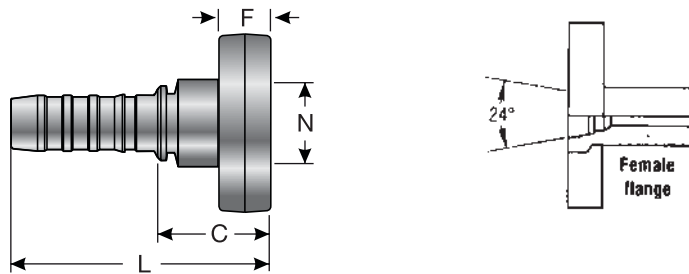

Descr.	Prod. No.	⊖		N	L		C		F		Std. Pack
		"	mm		"	mm	"	mm	"	mm	
<b>STANDARD PACK</b>											
8GS-17MPFL	7347-93225	1/2	12.7	17	3.11	79.0	1.63	41.5	.56	14.2	1
10GS-21MPFL	7347-93005	5/8	15.8	21	3.27	83.0	1.29	32.7	.56	14.2	1
16GS-34MPFL	7347-93185	1	25.4	34	4.51	114.5	2.27	57.7	.56	14.2	1
20GS-42MPFL	7347-93475	1 1/4	31.7	42	6.77	172.0	3.96	100.9	.56	14.2	1

EQUIPMENT

HOSE/CPLG. SELECTION

GLOBALSPIRAL COUPLINGS

PCM/PCS FERRULES

MEGACRIMP COUPLINGS

POWER CRIMP COUPLINGS

LOW PRESSURE COUPLINGS

POLARSEAL COUPLINGS

C14 COUPLINGS

PCTS THERMO-PLASTIC COUPLINGS

FIELD ATTACHABLE G1 &amp; G2 COUPLINGS

FIELD ATTACHABLE C5 COUPLINGS

SURELOK AIR BRAKE COUPLINGS

QUICK DISCONNECT COUPLERS

NEW BALL VALVES

ACCESSORIES

EQUIPMENT AND PARTS





# GlobalSpiral™ Couplings

EQUIPMENT

HOSE/CPLG. SELECTION

GLOBALSPIRAL COUPLINGS

PCM/PCS FERRULES

MEGACRIMP COUPLINGS

POWER CRIMP COUPLINGS

LOW PRESSURE COUPLINGS

POLARSEAL COUPLINGS

C14 COUPLINGS

PCTS THERMO-PLASTIC COUPLINGS

FIELD ATTACHABLE G1 & G2 COUPLINGS

FIELD ATTACHABLE C5 COUPLINGS

SURELOK AIR BRAKE COUPLINGS

QUICK DISCONNECT COUPLERS

NEW BALL VALVES

ACCESSORIES

EQUIPMENT AND PARTS

## Male French GAZ

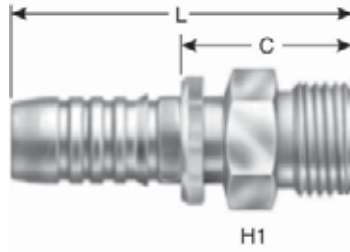

Descr.	Prod. No.	⊖			H1	H2	L		C		Std. Pack
		"	mm		mm	mm	"	mm	"	mm	
<b>STANDARD PACK</b>											
12GS-21MFG	7347-94075	3/4	19.1	M30X1.5	32.0	—	3.23	82.0	1.22	31.0	1
12GS-27MFG	7347-93055	3/4	19.1	M36X1.5	41.0	—	3.33	84.5	1.32	33.5	1

## Female French GAZ Swivel (Female Kobelco)

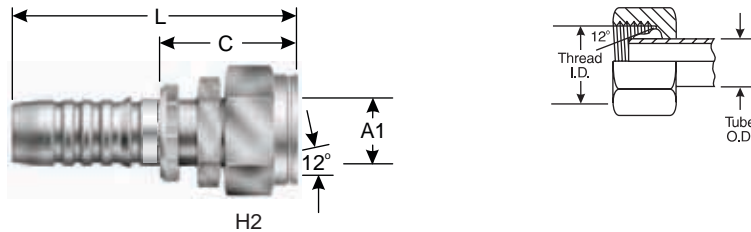

Descr.	Prod. No.	⊖			H1	H2	L		C		A1	Std. Pack
		"	mm		mm	mm	"	mm	"	mm	mm	
<b>STANDARD PACK</b>												
8GS-17FFGX	7347-90665	1/2	12.7	M24X1.5	—	30.0	2.68	68.0	1.20	30.5	16.8	1
10GS-21FFGX	7347-93025	5/8	15.8	M30X1.5	—	36.0	3.44	87.5	1.44	36.5	21.2	1
12GS-21FFGX	7347-94715	3/4	19.1	M30X1.5	—	36.0	3.27	83.0	1.29	32.7	21.2	1
12GS-27FFGX	7347-93075	3/4	19.1	M36X1.5	—	41.0	3.41	86.5	1.40	35.5	26.8	1
16GS-27FFGX	7347-94725	1	25.4	M36X1.5	—	41.0	3.41	86.5	1.40	35.5	26.8	1
16GS-34FFGX	7347-93175	1	25.4	M45X1.5	—	55.0	3.76	95.5	1.54	39.1	33.5	1





## Female French GAZ Swivel - 90° Bent Tube

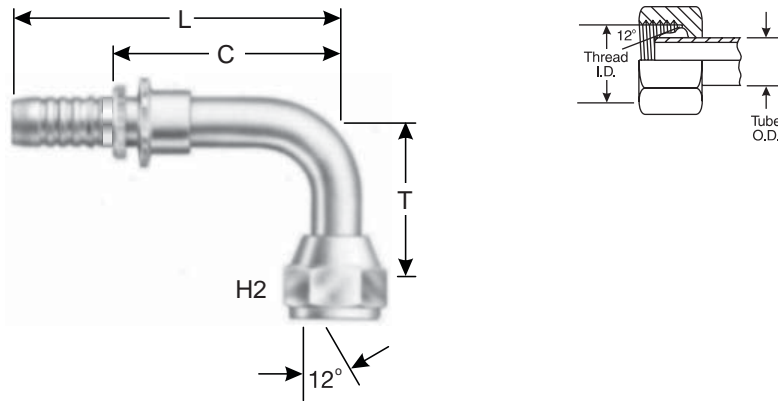

Descr.	Prod. No.	⊖		🌀	H1	H2	T		L		C		Std. Pack
		"	mm		mm	mm	"	mm	"	mm	"	mm	
<b>STANDARD PACK</b>													
10GS-21FFGX90	7347-93035	5/8	15.8	M30X1.5	—	36.0	1.77	45.0	3.62	92.0	1.64	41.7	1
12GS-21FFGX90	7347-94735	3/4	19.1	M30X1.5	—	36.0	2.00	50.8	4.91	124.7	2.90	73.7	1
12GS5K-27FFGX90-060	7347-78645	3/4	19.1	M36X1.5	—	41.0	2.36	60.0	4.91	124.7	2.90	73.7	1
16GS-27FFGX90	7347-94745	3/4	19.1	M30X1.5	—	41.0	2.64	67.0	5.94	151.0	3.72	94.6	1
16GS5K-34FFGX90-065	7347-78655	1	25.4	M45X1.5	—	55.0	2.56	65.0	5.67	144.0	3.45	87.6	1

## Female Komatsu Style Japanese Metric Swivel

These female swivels have been marked with two small notches on the hex to identify them as the Komatsu style.

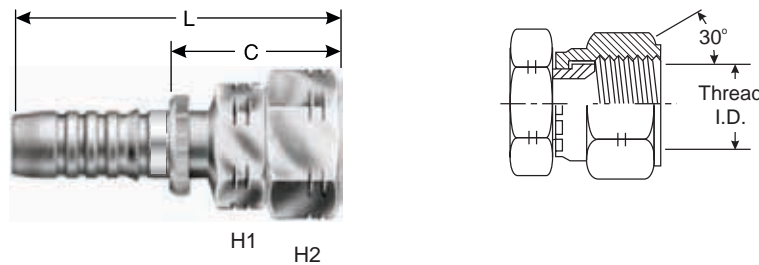

Descr.	Prod. No.	⊖		🌀	H1	H2	L		C		Std. Pack
		"	mm		mm	mm	"	mm	"	mm	
<b>STANDARD PACK</b>											
8GS-8FKX	7347-35245	1/2	12.7	M22X1.5	27.0	27.0	2.93	74.4	1.46	37.0	1
10GS-10FKX	7347-35345	5/8	15.8	M24X1.5	30.0	32.0	3.74	95.0	1.76	44.7	1
12GS-12FKX	7347-35445	3/4	19.1	M30X1.5	32.0	36.0	4.00	101.7	2.00	50.7	1
16GS-16FKX	7347-35555	1	25.4	M33X1.5	41.0	41.0	4.51	114.6	2.29	58.2	1

EQUIPMENT

HOSE/CPLG. SELECTION

GLOBALSPIRAL COUPLINGS

PCM/PCS FERRULES

MEGACRIMP COUPLINGS

POWER CRIMP COUPLINGS

LOW PRESSURE COUPLINGS

POLARSEAL COUPLINGS

C14 COUPLINGS

PCTS THERMO-PLASTIC COUPLINGS

FIELD ATTACHABLE G1 & G2 COUPLINGS

FIELD ATTACHABLE C5 COUPLINGS

SURELOK AIR BRAKE COUPLINGS

QUICK DISCONNECT COUPLERS

NEW BALL VALVES

ACCESSORIES

EQUIPMENT AND PARTS





# GlobalSpiral™ Couplings

## Female Japanese Industrial Standard 30° Flare Swivel

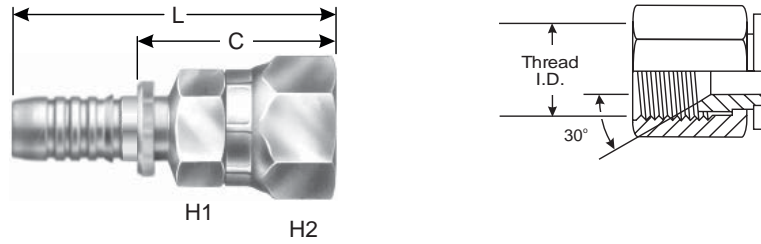

Descr.	Prod. No.	⊖		🌀	H1	H2	L		C		Std. Pack
		"	mm		mm	mm	"	mm	"	mm	
<b>STANDARD PACK</b>											
12GS-12FJISX	7347-76195	3/4	19.1	3/4-14	32.0	36.0	3.87	98.2	1.86	47.2	1
16GS-16FJISX	7347-76005	1	25.4	1-11	41.0	41.0	4.25	108.0	2.03	51.6	1
20GS-20FJISX	7347-76235	1 1/4	31.7	1 1/4-11	27.0	50.0	5.35	136.0	2.56	64.9	1

## GS Ferrule for 2-Wire Braid Hose

For 12M4K and 16M3K Hose Only.



Descr.	Prod. No.	⊖		L		∅		Std. Pack
		"	mm	"	mm	"	mm	
<b>STANDARD PACK</b>								
12GS1F-2	7347-02975	3/4	19.1	1.73	44.0	1.57	39.9	1
16GS1F-2	7347-02985	1	25.4	2.06	52.2	1.94	49.3	1
<b>BULK PACK</b>								
12GS1F-2 XBULK	7347-0297	3/4	19.1	1.73	44.0	1.57	39.9	125

## GSP Ferrule for Wire Braid Hose



Descr.	Prod. No.	⊖		L		∅		Std. Pack
		"	mm	"	mm	"	mm	
<b>STANDARD PACK</b>								
24GSP1F-2	7347-03165	1 1/2	38.1	2.98	75.8	2.76	70.0	1





## GSP Ferrule for Wire Braid Hose - Cont'd

Descr.	Prod. No.	⊖		L		∅		Std. Pack
		"	mm	"	mm	"	mm	
32FSP1F-2	7347-03185	2	50.8	3.54	90.0	3.29	83.5	1
<b>BULK PACK</b>								
24GSP1F-2XBULK	7347-0316	1 1/2	38.1	2.98	75.8	2.76	70.0	20
32GSP1F-2XBULK	7347-0318	2	50.8	3.54	90.0	3.29	83.5	10

## GS Ferrule for 4-Spiral Hose



Descr.	Prod. No.	⊖		L		∅		Std. Pack
		"	mm	"	mm	"	mm	
<b>STANDARD PACK</b>								
6GS1F-4	7347-03105	3/8	9.5	1.43	36.3	1.25	31.8	5
8GS1F-4	7347-03115	1/2	12.7	1.44	36.6	1.35	34.4	5
10GS1F-4	7347-03125	5/8	15.8	1.88	47.8	1.64	41.7	5
12GS1F-4	7347-03135	3/4	19.1	2.00	50.8	1.80	45.7	5
16GS1F-4	7347-03145	1	25.4	2.22	56.4	2.07	52.6	1
20GS1F-4	7347-03155	1 1/4	31.7	2.67	67.8	2.42	61.5	1
<b>BULK PACK</b>								
6GS1F-4XBULK	7347-0310	3/8	9.5	1.43	36.3	1.25	31.8	200
8GS1F-4XBULK	7347-0311	1/2	12.7	1.44	36.6	1.35	34.4	200
10GS1F-4XBULK	7347-0312	5/8	15.8	1.88	47.8	1.64	41.7	100
12GS1F-4XBULK	7347-0313	3/4	19.1	2.00	50.8	1.80	45.7	75
16GS1F-4XBULK	7347-0314	1	25.4	2.22	56.4	2.07	52.6	50
20GS1F-4XBULK	7347-0315	1 1/4	31.7	2.67	67.8	2.42	61.5	30

## GSP Ferrule for 4-Spiral EF Hose



Descr.	Prod. No.	⊖		L		∅		Std. Pack
		"	mm	"	mm	"	mm	
<b>STANDARD PACK</b>								
24GSP1F-4	7347-03175	1 1/2	38.1	3.01	76.5	2.83	72.0	1
32GSP1F-4	7347-03195	2	50.8	3.58	91.0	3.35	85.0	1

EQUIPMENT

HOSE/CPLG. SELECTION

GLOBALSPIRAL COUPLINGS

PCM/PCS FERRULES

MEGACRIMP COUPLINGS

POWER CRIMP COUPLINGS

LOW PRESSURE COUPLINGS

POLARSEAL COUPLINGS

C14 COUPLINGS

PCTS THERMO-PLASTIC COUPLINGS

FIELD ATTACHABLE G1 &amp; G2 COUPLINGS

FIELD ATTACHABLE C5 COUPLINGS

SURELOK AIR BRAKE COUPLINGS

QUICK DISCONNECT COUPLERS

NEW BALL VALVES

ACCESSORIES

EQUIPMENT AND PARTS



# GlobalSpiral™ Couplings



EQUIPMENT

HOSE/CPLG. SELECTION

GLOBALSPIRAL COUPLINGS

PCM/PCS FERRULES

MEGACRIMP COUPLINGS

POWER CRIMP COUPLINGS

LOW PRESSURE COUPLINGS

POLARSEAL COUPLINGS

C14 COUPLINGS

PCTS THERMO-PLASTIC COUPLINGS

FIELD ATTACHABLE G1 & G2 COUPLINGS

FIELD ATTACHABLE C5 COUPLINGS

SURELOK AIR BRAKE COUPLINGS

QUICK DISCONNECT COUPLERS

NEW BALL VALVES

ACCESSORIES

EQUIPMENT AND PARTS

## GSP Ferrule for 4-Spiral EF Hose - Cont'd

Descr.	Prod. No.	⊖		L		∅		Std. Pack
		"	mm	"	mm	"	mm	
<b>BULK PACK</b>								
24GSP1F-4XBULK	7347-0317	1 1/2	38.1	3.01	76.5	2.83	72.0	20
32GSP1F-4XBULK	7347-0319	2	50.8	3.58	91.0	3.35	85.0	10

## GS Ferrule for 6-Spiral Hose



Descr.	Prod. No.	⊖		L		∅		Std. Pack
		"	mm	"	mm	"	mm	
<b>STANDARD PACK</b>								
20GS1F-6	7347-02905	1 1/4	31.7	2.87	72.9	2.67	67.8	1
<b>BULK PACK</b>								
20GS1F-6XBULK	7347-0290	1 1/4	31.7	2.87	72.9	2.67	67.8	20

## 1 1/4" Special One-Piece Couplings - Male Pipe (NPTF - 30° Cone Seat)

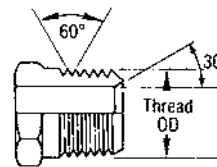
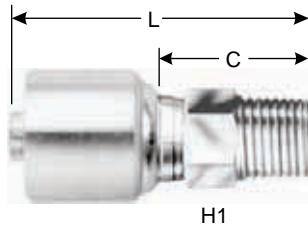

H1

Descr.	Prod. No.	⊖		∅	H1	H2	L		C		Std. Pack
		"	mm				"	mm	"	mm	
<b>STANDARD PACK</b>											
20MGS-20MP	7347-86005	1 1/4	31.7	1 1/4-1 1/2	1 3/4	—	5.00	127.0	2.20	55.9	1





## 1 1/4" Special One-Piece Couplings - Male JIC 37° Flare

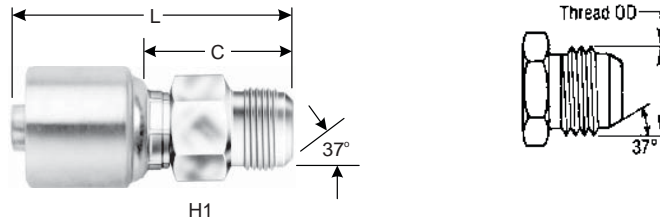

Descr.	Prod. No.	⊖		🌀	H1	H2	L		C		Std. Pack
		"	mm		"	"	"	mm	"	mm	
<b>STANDARD PACK</b>											
20MGS-20MJ	7347-86015	1 1/4	31.7	1 5/8-12	1 3/4	—	4.92	125.0	2.12	53.9	1

## 1 1/4" Special One-Piece Couplings - Female JIC 37° Flare Swivel

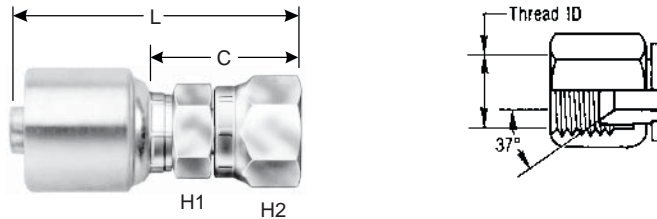

Descr.	Prod. No.	⊖		🌀	H1	H2	L		C		Std. Pack
		"	mm		"	"	"	mm	"	mm	
<b>STANDARD PACK</b>											
20MGS-20FJX	7347-86025	1 1/4	31.7	1 5/8-12	1 7/8	2	5.35	136.0	2.56	64.9	1

## 1 1/4" Special One-Piece Couplings - Female JIC 37° Flare Swivel - 90° Bent Tube

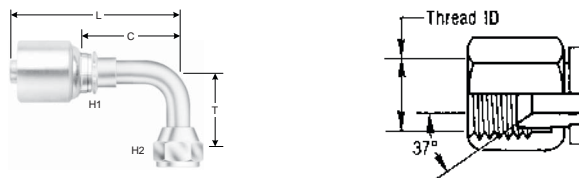

Descr.	Prod. No.	⊖		🌀	H1	H2	T	L		C		Std. Pack	
		"	mm		"	"	"	mm	"	mm	"		mm
<b>STANDARD PACK</b>													
20MGS-20FJX90M-078	7347-86035	1 1/4	31.7	1 5/8-12	1 7/8	2	3.07	78.0	6.85	174.0	4.05	102.9	1

EQUIPMENT

HOSE/CPLG. SELECTION

GLOBALSPIRAL COUPLINGS

PCM/PCS FERRULES

MEGACRIMP COUPLINGS

POWER CRIMP COUPLINGS

LOW PRESSURE COUPLINGS

POLARSEAL COUPLINGS

C14 COUPLINGS

PCTS THERMO-PLASTIC COUPLINGS

FIELD ATTACHABLE G1 &amp; G2 COUPLINGS

FIELD ATTACHABLE C5 COUPLINGS

SURELOK AIR BRAKE COUPLINGS

QUICK DISCONNECT COUPLERS

NEW BALL VALVES

ACCESSORIES

EQUIPMENT AND PARTS





# GlobalSpiral™ Couplings

EQUIPMENT

HOSE/CPLG. SELECTION

GLOBALSPIRAL COUPLINGS

PCM/PCS FERRULES

MEGACRIMP COUPLINGS

POWER CRIMP COUPLINGS

LOW PRESSURE COUPLINGS

POLARSEAL COUPLINGS

C14 COUPLINGS

PCTS THERMO-PLASTIC COUPLINGS

FIELD ATTACHABLE G1 & G2 COUPLINGS

FIELD ATTACHABLE C5 COUPLINGS

SURELOK AIR BRAKE COUPLINGS

QUICK DISCONNECT COUPLERS

NEW BALL VALVES

ACCESSORIES

EQUIPMENT AND PARTS

## 1 1/4" Special One-Piece Couplings - Female Flat-Face O-Ring Swivel

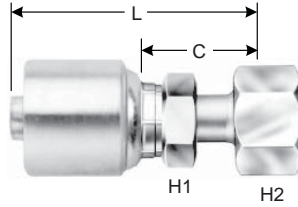

Descr.	Prod. No.	⊖			H1	H2	L		C		Std. Pack
		"	mm		mm	mm	"	mm	"	mm	
<b>STANDARD PACK</b>											
20MGS-20FFORX	7347-86045	1 1/4	31.7	1 11/16-12	50.0	50.0	5.04	128.0	2.24	56.9	1

## 1 1/4" Special One-Piece Couplings - Female Flat-Face O-Ring Swivel - 90° Bent Tube

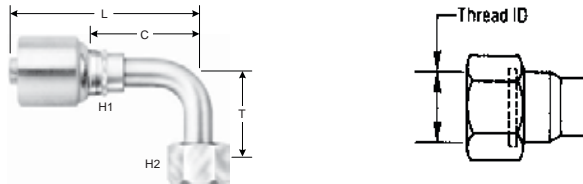

Descr.	Prod. No.	⊖			H1	H2	T	L		C		Std. Pack	
		"	mm		mm	mm	"	mm	"	mm			
<b>STANDARD PACK</b>													
20MGS-20FFORX90M	7347-86055	1 1/4	31.7	1 11/16-12	50.0	50.0	3.07	78.0	6.77	172.0	3.97	100.9	1

## 1 1/4" Special One-Piece Couplings - Code 61 O-Ring Flange

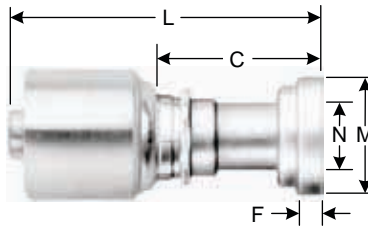

Descr.	Prod. No.	⊖		N	M	L		C		F	Std. Pack		
		"	mm	"	"	mm	mm	mm	mm	"		mm	
<b>STANDARD PACK</b>													
20MGS-20FL	7347-86065	1 1/4	31.7	1 1/4	2.00	50.8	5.75	146.0	2.95	74.9	.32	8.0	1





## 1 1/4" Special One-Piece Couplings - Code 61 O-Ring Flange - 45° Bent Tube

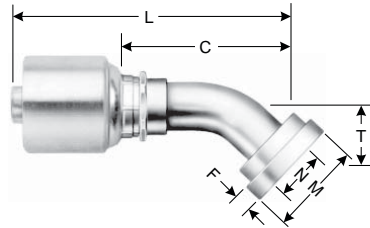

Descr.	Prod. No.	⊖		N	M	T		L		C		F		Std. Pack	
		"	mm	"	"	mm	"	mm	"	mm	"	mm	"		mm
<b>STANDARD PACK</b>															
20MGS-20FL45S-032	7347-86075	1 1/4	31.7	1 1/4	2.00	50.8	1.26	32.0	6.69	170.0	3.89	98.9	.32	8.0	1

## 1 1/4" Special One-Piece Couplings - Code 61 O-Ring Flange - 90° Bent Tube

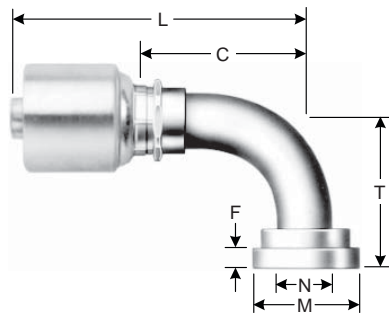

Descr.	Prod. No.	⊖		N	M	T		L		C		F		Std. Pack	
		"	mm	"	"	mm	"	mm	"	mm	"	mm	"		mm
<b>STANDARD PACK</b>															
20MGS-20FL90M-090	7347-86085	1 1/4	31.7	1 1/4	2.00	50.8	3.54	90.0	6.54	166.0	3.74	94.9	.32	8.0	1

## 1 1/4" Special One-Piece Couplings - Code 62 O-Ring Flange

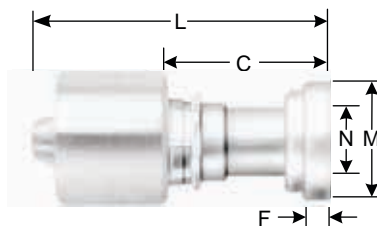

Descr.	Prod. No.	⊖		N	M	L		C		F		Std. Pack	
		"	mm	"	"	mm	"	mm	"	mm	"		mm
<b>STANDARD PACK</b>													
20MGS-20FLH	7347-86135	1 1/4	31.7	1 1/4	2.13	54.1	5.75	146.0	2.95	74.9	.41	10.3	1

EQUIPMENT

HOSE/CPLG. SELECTION

GLOBALSPIRAL COUPLINGS

PCM/PCS FERRULES

MEGACRIMP COUPLINGS

POWER CRIMP COUPLINGS

LOW PRESSURE COUPLINGS

POLARSEAL COUPLINGS

C14 COUPLINGS

PCTS THERMO-PLASTIC COUPLINGS

FIELD ATTACHABLE G1 &amp; G2 COUPLINGS

FIELD ATTACHABLE C5 COUPLINGS

SURELOK AIR BRAKE COUPLINGS

QUICK DISCONNECT COUPLERS

NEW BALL VALVES

ACCESSORIES

EQUIPMENT AND PARTS



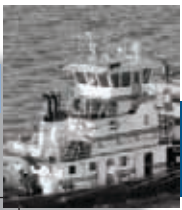

# GlobalSpiral™ Couplings

EQUIPMENT

HOSE/CPLG. SELECTION

GLOBALSPIRAL COUPLINGS

PCM/PCS FERRULES

MEGACRIMP COUPLINGS

POWER CRIMP COUPLINGS

LOW PRESSURE COUPLINGS

POLARSEAL COUPLINGS

C14 COUPLINGS

PCTS THERMO-PLASTIC COUPLINGS

FIELD ATTACHABLE G1 & G2 COUPLINGS

FIELD ATTACHABLE C5 COUPLINGS

SURELOK AIR BRAKE COUPLINGS

QUICK DISCONNECT COUPLERS

NEW BALL VALVES

ACCESSORIES

EQUIPMENT AND PARTS

## 1 1/4" Special One-Piece Couplings - Male DIN 24° Cone - Heavy Series

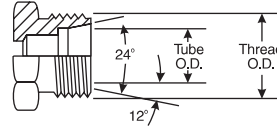
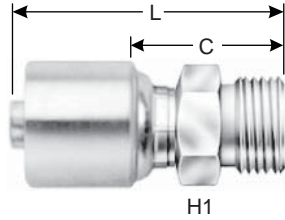

H1

Descr.	Prod. No.	⊖			H1	H2	L		C		Std. Pack
		"	mm		mm	mm	"	mm	"	mm	
<b>STANDARD PACK</b>											
20MGS-38MDH	7347-86115	1 1/4	31.7	M52X2.0	55.0	—	4.84	123.0	2.04	51.9	1

## 1 1/4" Special One-Piece Couplings - Female DIN 24° Cone Swivel - Heavy Series with O-Ring

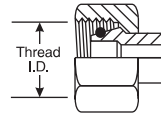
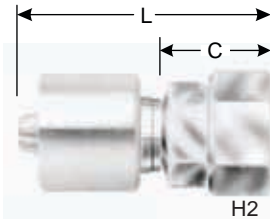

H2

Descr.	Prod. No.	⊖			H1	H2	L		C		Std. Pack
		"	mm		mm	mm	"	mm	"	mm	
<b>STANDARD PACK</b>											
20MGS-38FDHORX	7347-86095	1 1/4	31.7	M52X2.0	—	60.0	5.71	145.0	2.91	73.9	1

## 1 1/4" Special One-Piece Couplings - Female British Standard Pipe Parallel O-Ring Swivel

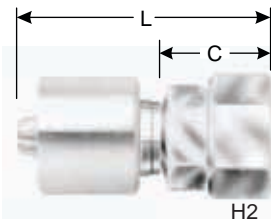

H2

Descr.	Prod. No.	⊖			H1	H2	L		C		Std. Pack
		"	mm		mm	mm	"	mm	"	mm	
<b>STANDARD PACK</b>											
20MGS-20FBSPORX	7347-86105	1 1/4	31.7	1 1/4-11	—	50.0	4.59	116.5	1.79	45.4	1





## Male JIC 37° Flare

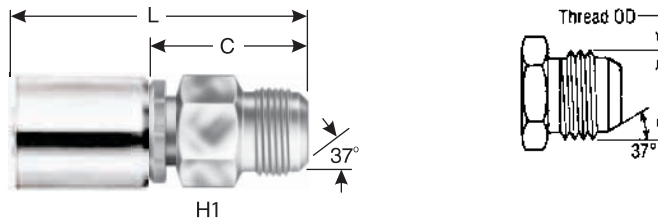

Descr.	Prod. No.	⊖		🌀	H1	H2	L		C		Std. Pack
		"	mm				"	mm	"	mm	
<b>STANDARD PACK</b>											
24GSH-24MJ	7341-02555	1 1/2	38.1	1 7/8-12	1.97	—	6.39	162.3	2.65	67.3	1
32GSH-32MJ	7341-06465	2	50.8	2 1/2-12	2.56	—	7.72	196.2	3.24	82.2	1

## Male Pipe (NPTF - 30° Cone Seat)

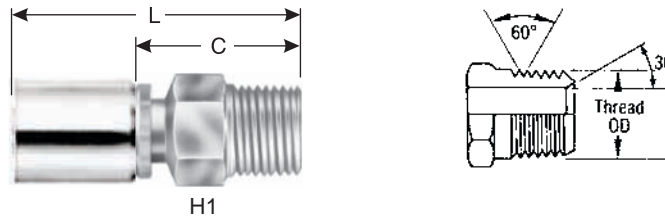

Descr.	Prod. No.	⊖		🌀	H1	H2	L		C		Std. Pack
		"	mm				"	mm	"	mm	
<b>STANDARD PACK</b>											
24GSH-24MP	7341-02585	2	50.8	1 1/2-11	2.00	—	6.51	165.3	2.77	70.3	1
32GSH-32MP	7341-06455	2	50.8	2-11 1/2	2.75	—	7.54	191.6	3.05	77.5	1
<b>BULK PACK</b>											
24GSH-24MPXBULK	7341-0258	2	50.8	1 1/2-11	2.00	—	6.51	165.3	2.77	70.3	10
32GSH-32MPXBULK	7341-0645	2	50.8	2-11 1/2	2.75	—	7.54	191.6	3.05	77.5	5

## Male Pipe for API Unions

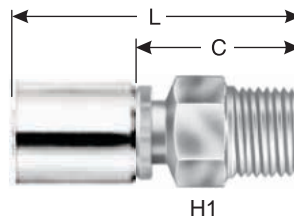

Descr.	Prod. No.	⊖		🌀	H1	H2	L		C		Std. Pack
		"	mm				"	mm	"	mm	
<b>STANDARD PACK</b>											
32GSH-32MPAPI	7341-06475	2	50.8	2-11 1/2	2.75	—	9.39	238.4	4.90	124.4	1
<b>BULK PACK</b>											
32GSH-32MPAPIXBULK	7341-0647	2	50.8	2-11 1/2	2.75	—	9.39	238.4	4.90	124.4	5

EQUIPMENT

HOSE/CPLG. SELECTION

GLOBALSPIRAL COUPLINGS

PCM/PCS FERRULES

MEGACRIMP COUPLINGS

POWER CRIMP COUPLINGS

LOW PRESSURE COUPLINGS

POLARSEAL COUPLINGS

C14 COUPLINGS

PCTS THERMO-PLASTIC COUPLINGS

FIELD ATTACHABLE G1 &amp; G2 COUPLINGS

FIELD ATTACHABLE C5 COUPLINGS

SURELOK AIR BRAKE COUPLINGS

QUICK DISCONNECT COUPLERS

NEW BALL VALVES

ACCESSORIES

EQUIPMENT AND PARTS



# GlobalSpiral™ - High Pressure Couplings

EQUIPMENT

HOSE/CPLG. SELECTION

GLOBALSPIRAL COUPLINGS

PCM/PCS FERRULES

MEGACRIMP COUPLINGS

POWER CRIMP COUPLINGS

LOW PRESSURE COUPLINGS

POLARSEAL COUPLINGS

C14 COUPLINGS

PCTS THERMO-PLASTIC COUPLINGS

FIELD ATTACHABLE G1 &amp; G2 COUPLINGS

FIELD ATTACHABLE C5 COUPLINGS

SURELOK AIR BRAKE COUPLINGS

QUICK DISCONNECT COUPLERS

NEW BALL VALVES

ACCESSORIES

EQUIPMENT AND PARTS

## Female JIC 37° Flare Swivel

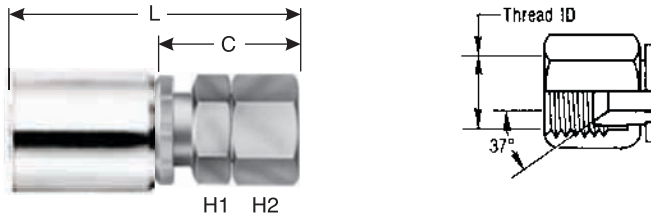

Descr.	Prod. No.	⊖		🌀	H1	H2	L		C		Std. Pack
		"	mm		"	"	"	mm	"	mm	
<b>STANDARD PACK</b>											
32GSH-32FJX	7341-06445	2	50.8	2 1/2-12	2.76	2.95	8.07	205.1	3.59	91.1	1
<b>BULK PACK</b>											
24GSH-24FJX XBULK	7341-0252	1 1/2	38.1	1 7/8-12	2.17	2.36	6.78	172.3	3.04	77.2	10
32GSH-32FJX XBULK	7341-0644	2	50.8	2 1/2-12	2.76	2.95	8.07	205.1	3.59	91.1	5

## Female Flat-Face Swivel

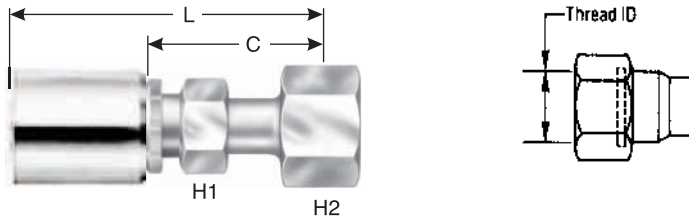

Descr.	Prod. No.	⊖		🌀	H1	H2	L		C		Std. Pack
		"	mm		"	"	"	mm	"	mm	
<b>STANDARD PACK</b>											
24GSH-24FFORX	7341-02445	1 1/2	38.1	2-12	2.17	2.36	6.47	164.4	2.73	69.4	1
24GSH-24FJX	7341-02525	1 1/2	38.1	1 7/8-12	2.17	2.36	6.78	172.3	3.04	77.2	1
<b>BULK PACK</b>											
24GSH-24FFORXXBULK	7341-0244	1 1/2	38.1	2-12	2.17	2.36	6.47	164.4	2.73	69.4	10

## Code 61 O-Ring Flange

Maximum working pressure 3,000 PSI.

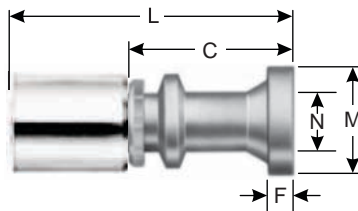

Descr.	Prod. No.	⊖		N	M	L		C		F		Std. Pack	
		"	mm	"	"	"	mm	"	mm	"	mm		
<b>STANDARD PACK</b>													
24GSH-24FL	7341-01905	1 1/2	38.1	1 1/2	2.38	60.3	7.09	180.0	3.35	85.0	.31	8.0	1
24GSH-32FL	7341-01915	1 1/2	38.1	2	2.81	71.4	7.40	188.0	3.66	93.0	.38	9.5	1



## Code 61 O-Ring Flange - Cont'd

Descr.	Prod. No.	⊖		N	M		L		C		F		Std. Pack
		"	mm		"	"	mm	"	mm	"	mm	"	
32GSH-32FL	7341-06335	2	50.8	2	2.81	71.4	9.90	251.4	5.41	137.4	.38	9.5	1
<b>BULK PACK</b>													
24GSH-24FLXBULK	7341-0190	1 1/2	38.1	1 1/2	2.38	60.3	7.09	180.0	3.35	85.0	.31	8.0	9
32GSH-32FLXBULK	7341-0633	2	50.8	2	2.81	71.4	9.90	251.4	5.41	137.4	.38	9.5	5

## Code 61 O-Ring Flange - 45° Bent Tube

Maximum working pressure 3,000 PSI.

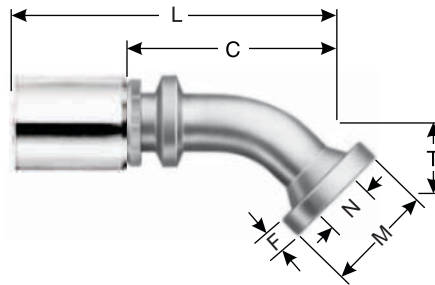

Descr.	Prod. No.	⊖		N	M		T		L		C		F		Std. Pack
		"	mm		"	"	mm	"	mm	"	mm	"	mm	"	
<b>STANDARD PACK</b>															
24GSH-24FL45M	7341-01945	1 1/2	38.1	1 1/2	2.38	60.3	1.73	44.0	9.05	230.0	5.31	135.0	.31	8.0	1
32GSH-32FL45M	7341-06345	2	50.8	2	2.81	71.4	2.20	56.0	11.30	287.0	6.83	173.5	.38	9.5	1

## Code 61 O-Ring Flange - 60° Bent Tube

Maximum working pressure 3,000 PSI.

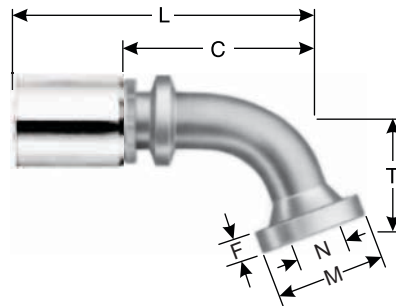

Descr.	Prod. No.	⊖		N	M		T		L		C		F		Std. Pack
		"	mm		"	"	mm	"	mm	"	mm	"	mm	"	
<b>BULK PACK</b>															
24GSH-24FL60MXBULK	7341-01965	1 1/2	38.1	1 1/2	2.38	60.3	2.52	64.0	9.50	241.2	5.75	146.2	.31	8.0	1

EQUIPMENT

HOSE/CPLG. SELECTION

GLOBALSPIRAL COUPLINGS

PCM/PCS FERRULES

MEGACRIMP COUPLINGS

POWER CRIMP COUPLINGS

LOW PRESSURE COUPLINGS

POLARSEAL COUPLINGS

C14 COUPLINGS

PCTS THERMO-PLASTIC COUPLINGS

FIELD ATTACHABLE G1 & G2 COUPLINGS

FIELD ATTACHABLE C5 COUPLINGS

SURELOK AIR BRAKE COUPLINGS

QUICK DISCONNECT COUPLERS

NEW BALL VALVES

ACCESSORIES

EQUIPMENT AND PARTS





# GlobalSpiral™ - High Pressure Couplings

EQUIPMENT

HOSE/CPLG. SELECTION

GLOBALSPIRAL COUPLINGS

PCM/PCS FERRULES

MEGACRIMP COUPLINGS

POWER CRIMP COUPLINGS

LOW PRESSURE COUPLINGS

POLARSEAL COUPLINGS

C14 COUPLINGS

PCTS THERMO-PLASTIC COUPLINGS

FIELD ATTACHABLE G1 & G2 COUPLINGS

FIELD ATTACHABLE C5 COUPLINGS

SURELOK AIR BRAKE COUPLINGS

QUICK DISCONNECT COUPLERS

NEW BALL VALVES

ACCESSORIES

EQUIPMENT AND PARTS

## Code 61 O-Ring Flange - 90° Bent Tube

Maximum working pressure 3,000 PSI.

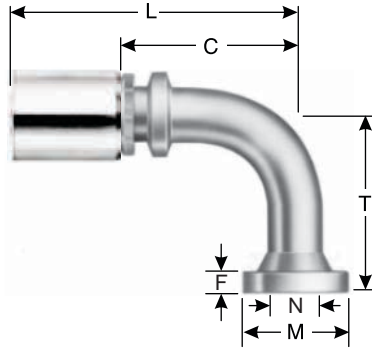

Descr.	Prod. No.	⊖		N	M		T		L		C		F		Std. Pack
		"	mm		"	"	mm	"	mm	"	mm	"	mm	"	
<b>STANDARD PACK</b>															
24GSH-24FL90S	7341-01985	1 1/2	38.1	1 1/2	2.38	60.3	3.19	81.0	8.46	214.9	4.72	119.9	.31	8.0	1
24GSH-32FLH90S	7341-02365	1 1/2	38.1	2	2.81	71.4	4.72	120.0	8.42	214.0	4.68	118.9	.38	9.5	1
32GSH-32FL90-130	7341-06355	1	25.4	2	2.81	71.4	5.12	130.0	10.39	264.0	5.94	150.5	.38	9.5	1
<b>BULK PACK</b>															
32GSH-32FL90-130XBULK	7341-0635	2	50.8	2	2.81	71.4	5.12	130.0	10.39	264.0	5.94	150.5	.38	9.5	2

## Code 62 O-Ring Flange Heavy

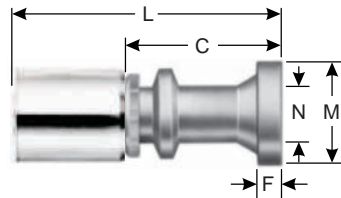

Descr.	Prod. No.	⊖		N	M		L		C		F		Std. Pack
		"	mm		"	"	mm	"	mm	"	mm	"	
<b>STANDARD PACK</b>													
24GSH-24FLH	7341-02255	1 1/2	38.1	1 1/2	2.50	63.5	7.87	200.0	4.13	105.0	.50	12.6	1
24GSH-32FLH	7341-02265	1 1/2	38.1	2	3.13	79.5	7.87	200.0	4.13	105.0	.50	12.6	1
32GSH-24FLH	7341-06135	2	50.8	1 1/2	2.50	63.5	9.04	229.6	4.55	115.6	.50	12.6	1
32GSH-32FLH	7341-15605	2	50.8	2	3.13	79.5	9.90	251.4	5.41	137.4	.50	12.6	1
<b>BULK PACK</b>													
24GSH-24FLHXBULK	7341-0225	1 1/2	38.1	1 1/2	2.50	63.5	7.87	200.0	4.13	105.0	.50	12.6	9
24GSH-32FLHXBULK	7341-0226	1 1/2	38.1	2	3.13	79.5	7.87	200.0	4.13	105.0	.50	12.6	10
32GSH-32FLH XBULK	7341-1560	2	50.8	2	3.13	79.5	9.90	251.4	5.41	137.4	.50	12.6	5





## Code 62 O-Ring Flange Heavy - 30° Bent Tube

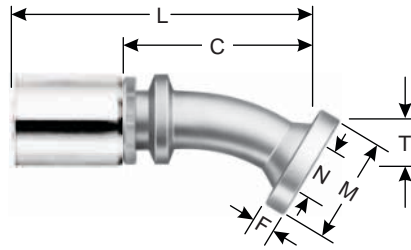

Descr.	Prod. No.	⊖		N	M		T		L		C		F		Std. Pack
		"	mm		"	"	mm	"	mm	"	mm	"	mm	"	
<b>STANDARD PACK</b>															
24GSH-24FLH30M	7341-02295	1 1/2	38.1	1 1/2	2.50	63.5	3.54	30.0	9.45	240.0	5.70	144.8	.50	12.6	1

## Code 62 O-Ring Flange Heavy - 45° Bent Tube

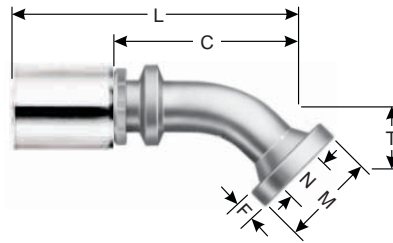

Descr.	Prod. No.	⊖		N	M		T		L		C		F		Std. Pack
		"	mm		"	"	mm	"	mm	"	mm	"	mm	"	
<b>STANDARD PACK</b>															
24GSH-24FLH45M	7341-02315	1 1/2	38.1	1 1/2	2.50	63.5	1.73	44.0	9.13	232.0	5.39	137.0	.50	12.6	1
32GSH-32FLH45-063	7341-06225	2	50.8	2	3.13	79.5	2.48	63.0	11.67	296.5	7.18	182.5	.50	12.7	1
<b>BULK PACK</b>															
24GSH-24FLH45XBULK	7341-0231	1 1/2	38.1	1 1/2	2.50	63.5	1.73	44.0	9.13	232.0	5.39	137.0	.50	12.6	15
32GSH-32FLH45-063XBULK	7341-0622	2	50.8	2	3.13	79.5	2.48	63.0	11.67	296.5	7.18	182.5	.50	12.6	2

## Code 62 O-Ring Flange Heavy - 60° Bent Tube

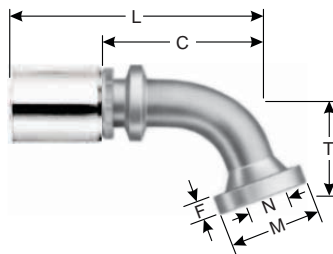

Descr.	Prod. No.	⊖		N	M		T		L		C		F		Std. Pack
		"	mm		"	"	mm	"	mm	"	mm	"	mm	"	
<b>STANDARD PACK</b>															
24GSH-24FLH60M	7341-02335	1 1/2	38.1	1 1/2	2.50	63.5	2.50	64.0	9.25	253.0	6.23	158.2	.50	12.6	1

EQUIPMENT

HOSE/CPLG. SELECTION

GLOBALSPIRAL COUPLINGS

PCM/PCS FERRULES

MEGACRIMP COUPLINGS

POWER CRIMP COUPLINGS

LOW PRESSURE COUPLINGS

POLARSEAL COUPLINGS

C14 COUPLINGS

PCTS THERMO-PLASTIC COUPLINGS

FIELD ATTACHABLE G1 &amp; G2 COUPLINGS

FIELD ATTACHABLE C5 COUPLINGS

SURELOK AIR BRAKE COUPLINGS

QUICK DISCONNECT COUPLERS

NEW BALL VALVES

ACCESSORIES

EQUIPMENT AND PARTS





# GlobalSpiral™ - High Pressure Couplings

## Code 62 O-Ring Flange Heavy - 90° Bent Tube

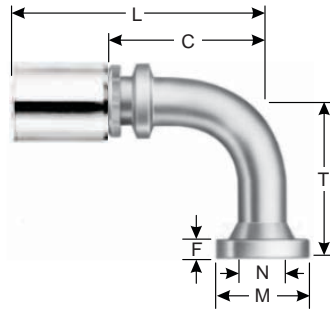

Descr.	Prod. No.	⊖		N		M		T		L		C		F		Std. Pack
		"	mm	"	"	"	mm	"	mm	"	mm	"	mm	"	mm	
<b>STANDARD PACK</b>																
32GSH-32FLH90-159	7341-15615	2	50.8	2	3.13	79.5	6.26	159.0	10.41	264.4	5.92	150.4	.50	12.6	1	
32GSH-32FLH90M	7341-06275	2	50.8	2	3.13	79.5	5.40	138.0	10.41	264.0	6.24	150.5	.50	12.6	1	
<b>BULK PACK</b>																
32GSH-32FLH90-159XBULK	7341-1561	2	50.8	2	3.13	79.5	6.26	159.0	10.41	264.4	5.92	150.4	.50	12.6	2	

## Code 62 O-Ring Flange Heavy - 90° Medium Bent Tube

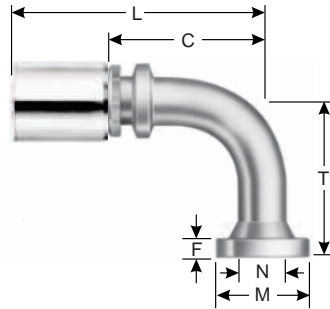

Descr.	Prod. No.	⊖		N		M		T		L		C		F		Std. Pack
		"	mm	"	"	"	mm	"	mm	"	mm	"	mm	"	mm	
<b>STANDARD PACK</b>																
24GSH-24FLH90-094	7341-02355	1 1/2	38.1	1 1/2	2.50	63.5	3.70	94.0	8.73	214.0	4.68	118.9	.50	12.6	1	
<b>BULK PACK</b>																
24GSH-24FLH90-094XBULK	7341-0235	1 1/2	38.1	1 1/2	2.50	63.5	3.70	94.0	8.43	214.0	4.68	118.9	.50	12.6	5	

- EQUIPMENT
- HOSE/CPLG. SELECTION
- GLOBALSPIRAL COUPLINGS
- PCM/PCS FERRULES
- MEGACRIMP COUPLINGS
- POWER CRIMP COUPLINGS
- LOW PRESSURE COUPLINGS
- POLARSEAL COUPLINGS
- C14 COUPLINGS
- PCTS THERMO-PLASTIC COUPLINGS
- FIELD ATTACHABLE G1 & G2 COUPLINGS
- FIELD ATTACHABLE C5 COUPLINGS
- SURELOK AIR BRAKE COUPLINGS
- QUICK DISCONNECT COUPLERS
- NEW BALL VALVES
- ACCESSORIES
- EQUIPMENT AND PARTS





## Caterpillar Style O-Ring Flange

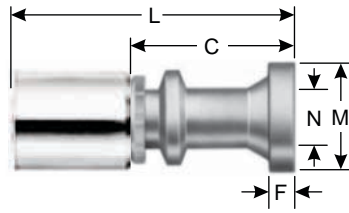

Descr.	Prod. No.	⊖		N		M		L		C		F		Std. Pack
		"	mm	"	"	mm	mm	"	mm	"	mm	"	mm	
<b>STANDARD PACK</b>														
24GSH-24FLC	7341-02055	1 1/2	38.1	1 1/2	2.50	63.5	7.44	189.0	3.71	94.3	.56	14.2	1	
24GSH-24FLCL	7341-02175	1 1/2	38.1	1 1/2	2.50	63.5	9.37	238.0	5.64	143.2	.56	14.2	1	
32GSH-32FLC	7341-06385	2	30.8	2	3.13	79.4	8.96	227.7	4.48	113.7	.56	14.2	1	

## Caterpillar Style O-Ring Flange - 30° Bent Tube

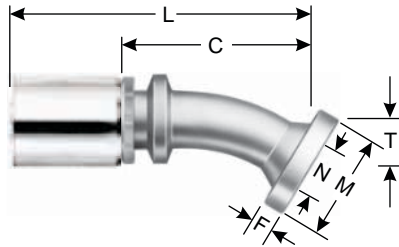

Descr.	Prod. No.	⊖		N		M		T		L		C		F		Std. Pack
		"	mm	"	"	mm	mm	"	mm	"	mm	"	mm	"	mm	
<b>STANDARD PACK</b>																
24GSH-24FLC30-023	7341-02095	1 1/2	38.1	1 1/2	2.50	63.5	.90	23.0	9.25	235.0	5.49	139.5	.56	14.2	1	

## Caterpillar Style O-Ring Flange - 45° Bent Tube

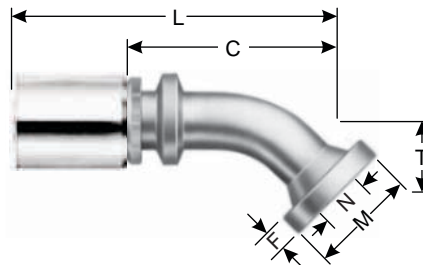

Descr.	Prod. No.	⊖		N		M		T		L		C		F		Std. Pack
		"	mm	"	"	mm	mm	"	mm	"	mm	"	mm	"	mm	
<b>STANDARD PACK</b>																
24GSH-24FLC45-039	7341-02115	1 1/2	38.1	1 1/2	2.50	63.5	1.54	39.0	8.94	227.0	5.20	132.0	.56	14.2	1	

- EQUIPMENT
- HOSE/CPLG. SELECTION
- GLOBALSPIRAL COUPLINGS**
- PCM/PCS FERRULES
- MEGACRIMP COUPLINGS
- POWER CRIMP COUPLINGS
- LOW PRESSURE COUPLINGS
- POLARSEAL COUPLINGS
- C14 COUPLINGS
- PCTS THERMO-PLASTIC COUPLINGS
- FIELD ATTACHABLE G1 & G2 COUPLINGS
- FIELD ATTACHABLE C5 COUPLINGS
- SURELOK AIR BRAKE COUPLINGS
- QUICK DISCONNECT COUPLERS
- NEW BALL VALVES
- ACCESSORIES
- EQUIPMENT AND PARTS



# GlobalSpiral™ - High Pressure Couplings



## Caterpillar Style O-Ring Flange - 60° Bent Tube

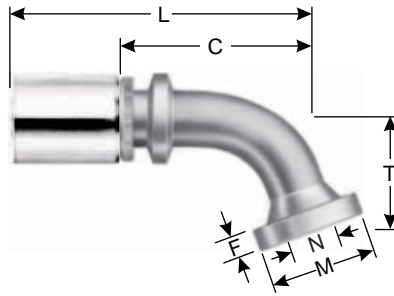

Descr.	Prod. No.	⊖		N	M		T		L		C		F		Std. Pack
		"	mm		"	"	mm	"	mm	"	mm	"	mm	"	
<b>STANDARD PACK</b>															
24GSH-24FLC60-055	7341-02135	1 1/2	38.1	1 1/2	2.50	63.5	2.17	55.0	9.91	251.6	6.17	156.6	.56	14.2	1
32GSH-32FLC60-083	7341-06405	2	50.8	2	3.13	79.4	3.27	83.0	12.67	322.0	8.17	207.5	.56	14.2	1

## Caterpillar Style O-Ring Flange - 90° Bent Tube

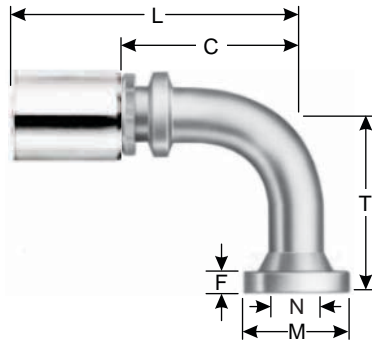

Descr.	Prod. No.	⊖		N	M		T		L		C		F		Std. Pack
		"	mm		"	"	mm	"	mm	"	mm	"	mm	"	
<b>STANDARD PACK</b>															
24GSH-24FLC90-087	7341-02155	1 1/2	38.1	1 1/2	2.50	63.5	3.43	87.0	8.43	214.4	4.70	119.1	.56	14.2	1
32GSH-32FLC90-130	7341-06415	2	50.8	2	3.13	79.4	5.12	130.0	10.40	264.4	5.92	150.4	.56	14.2	1

EQUIPMENT

HOSE/CPLG. SELECTION

GLOBALSPIRAL COUPLINGS

PCM/PCS FERRULES

MEGACRIMP COUPLINGS

POWER CRIMP COUPLINGS

LOW PRESSURE COUPLINGS

POLARSEAL COUPLINGS

C14 COUPLINGS

PCTS THERMO-PLASTIC COUPLINGS

FIELD ATTACHABLE G1 &amp; G2 COUPLINGS

FIELD ATTACHABLE C5 COUPLINGS

SURELOK AIR BRAKE COUPLINGS

QUICK DISCONNECT COUPLERS

NEW BALL VALVES

ACCESSORIES

EQUIPMENT AND PARTS

