

# Field Attachable for C5C, C5D & C5M Hose

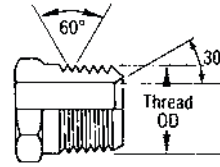

## Male Pipe (NPTF - 30° Cone Seat) - Steel

DOT FMVSS 106-74 Type All.

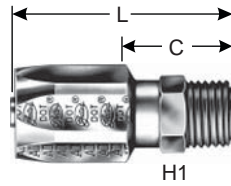

| Descr.               | Prod. No.  | ⊖       |      | 🌀            | H1      | H2 | L    |       | C    |      | Std. Pack |
|----------------------|------------|---------|------|--------------|---------|----|------|-------|------|------|-----------|
|                      |            | "       | mm   |              |         |    | "    | mm    | "    | mm   |           |
| <b>STANDARD PACK</b> |            |         |      |              |         |    |      |       |      |      |           |
| 4C5-2RMP             | 7236-04015 | 3/16    | 4.8  | 1/8-27       | 1/2     | —  | 1.64 | 41.6  | .94  | 23.9 | 1         |
| 4C5-4RMP             | 7236-04025 | 3/16    | 4.8  | 1/4-18       | 9/16    | —  | 1.83 | 46.5  | 1.13 | 28.7 | 1         |
| 5C5-2RMP             | 7236-04035 | 1/4     | 6.4  | 1/8-27       | 1/2     | —  | 1.77 | 45.0  | 1.00 | 25.4 | 1         |
| 5C5-4RMP             | 7236-04045 | 1/4     | 6.4  | 1/4-18       | 9/16    | —  | 1.96 | 49.8  | 1.19 | 30.2 | 1         |
| 6C5-4RMP             | 7236-04055 | 5/16    | 7.9  | 1/4-18       | 9/16    | —  | 2.17 | 55.1  | 1.22 | 31.0 | 1         |
| 6C5-6RMP             | 7236-04275 | 5/16    | 7.9  | 3/8-18       | 11/16   | —  | 2.17 | 55.1  | 1.22 | 31.0 | 1         |
| 8C5-6RMP             | 7236-04065 | 13/32   | 10.3 | 3/8-18       | 11/16   | —  | 2.46 | 62.5  | 1.34 | 34.0 | 1         |
| 8C5-8RMP             | 7236-04075 | 13/32   | 10.3 | 1/2-14       | 7/8     | —  | 2.71 | 68.8  | 1.59 | 40.4 | 1         |
| 10C5-8RMP            | 7236-04085 | 1/2     | 12.7 | 1/2-14       | 1 1/16  | —  | 2.88 | 73.2  | 1.59 | 40.4 | 1         |
| 10C5-12RMP           | 7236-04095 | 1/2     | 12.7 | 3/4-14       | 1       | —  | 2.95 | 74.9  | 1.66 | 42.2 | 1         |
| 12C5-8RMP            | 7236-04105 | 5/8     | 15.9 | 1/2-14       | 7/8     | —  | 3.15 | 80.1  | 1.59 | 40.4 | 1         |
| 12C5-12RMP           | 7236-04115 | 5/8     | 15.9 | 3/4-14       | 1 1/16  | —  | 3.25 | 82.7  | 1.69 | 42.9 | 1         |
| 16C5-12RMP           | 7236-86412 | 7/8     | 22.2 | 3/4-14       | 1 1/8   | —  | 2.71 | 68.8  | 1.53 | 38.9 | 1         |
| 16C5-16RMP           | 7236-86413 | 7/8     | 22.2 | 1-11 1/2     | 1 3/8   | —  | 2.90 | 73.7  | 1.72 | 43.7 | 1         |
| 20C5-20RMP           | 7236-86428 | 1 1/8   | 28.6 | 1 1/4-11 1/2 | 1 11/16 | —  | 3.25 | 82.5  | 1.88 | 47.8 | 1         |
| 24C5-24RMP           | 7236-86388 | 1 3/8   | 34.9 | 1 1/2-11 1/2 | 2       | —  | 3.45 | 87.6  | 2.03 | 51.6 | 1         |
| 32C5-32RMP           | 7236-86389 | 1 13/16 | 46.0 | 2-11 1/2     | 2 1/2   | —  | 4.07 | 103.4 | 2.22 | 56.4 | 1         |
| <b>BULK PACK</b>     |            |         |      |              |         |    |      |       |      |      |           |
| 4C5-4RMPXBULK        | 7236-0402  | 3/16    | 4.8  | 1/4-18       | 9/16    | —  | 1.83 | 46.5  | 1.13 | 28.7 | 500       |
| 5C5-4RMPXBULK        | 7236-0404  | 1/4     | 6.4  | 1/4-18       | 9/16    | —  | 1.96 | 49.8  | 1.19 | 30.2 | 230       |
| 6C5-4RMPXBULK        | 7236-0405  | 5/16    | 7.9  | 1/4-18       | 9/16    | —  | 2.17 | 55.1  | 1.22 | 31.0 | 175       |
| 8C5-8RMPXBULK        | 7236-0407  | 13/32   | 10.3 | 1/2-14       | 7/8     | —  | 2.71 | 68.8  | 1.59 | 40.4 | 130       |
| 10C5-8RMPXBULK       | 7236-0408  | 1/2     | 12.7 | 1/2-14       | 1 1/16  | —  | 2.88 | 73.2  | 1.59 | 40.4 | 80        |
| 10C5-12RMPXBULK      | 7236-0409  | 1/2     | 12.7 | 3/4-14       | 1       | —  | 2.95 | 74.9  | 1.66 | 42.2 | 80        |
| 12C5-12RMPXBULK      | 7236-0411  | 5/8     | 15.9 | 3/4-14       | 1 1/16  | —  | 3.25 | 82.7  | 1.69 | 42.9 | 50        |

## Male Pipe (NPTF - 30° Cone Seat) - Brass

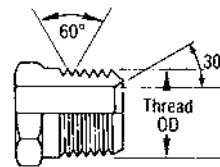
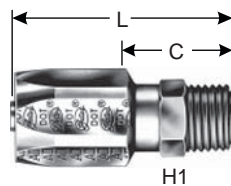

| Descr.               | Prod. No.  | ⊖     |      | 🌀      | H1    | H2 | L    |      | C    |      | Std. Pack |
|----------------------|------------|-------|------|--------|-------|----|------|------|------|------|-----------|
|                      |            | "     | mm   |        |       |    | "    | mm   | "    | mm   |           |
| <b>STANDARD PACK</b> |            |       |      |        |       |    |      |      |      |      |           |
| 5C5-4RMPB            | 7236-03005 | 1/4   | 6.3  | 1/4-18 | 9/16  | —  | 1.96 | 49.8 | 1.19 | 30.2 | 1         |
| 6C5-6RMPB            | 7236-03015 | 5/16  | 7.9  | 3/8-18 | 11/16 | —  | 2.17 | 55.1 | 1.22 | 31.0 | 1         |
| 8C5-8RMPB            | 7236-03085 | 13/32 | 10.3 | 1/2-14 | 7/8   | —  | 2.71 | 68.8 | 1.59 | 40.4 | 1         |

|                                    |
|------------------------------------|
| EQUIPMENT                          |
| HOSE/CPLG. SELECTION               |
| GLOBALSPIRAL COUPLINGS             |
| PCM/PCS FERRULES                   |
| MEGACRIMP COUPLINGS                |
| POWER CRIMP COUPLINGS              |
| LOW PRESSURE COUPLINGS             |
| POLARSEAL COUPLINGS                |
| C14 COUPLINGS                      |
| PCTS THERMO-PLASTIC COUPLINGS      |
| FIELD ATTACHABLE G1 & G2 COUPLINGS |
| FIELD ATTACHABLE C5 COUPLINGS      |
| SURELOK AIR BRAKE COUPLINGS        |
| QUICK DISCONNECT COUPLERS          |
| NEW BALL VALVES                    |
| ACCESSORIES                        |
| EQUIPMENT AND PARTS                |



The World's Most Trusted Name in Belts, Hose and Hydraulics.

[www.gates.com/hydraulics](http://www.gates.com/hydraulics)

M1



# Field Attachable for C5C, C5D & C5M Hose

## Male Pipe (NPTF - 30° Cone Seat) - Brass - Cont'd

| Descr.      | Prod. No.  | ⊖   |      |          | H1     | H2 | L    |      | C    |      | Std. Pack |
|-------------|------------|-----|------|----------|--------|----|------|------|------|------|-----------|
|             |            | "   | mm   |          |        |    | "    | mm   | "    | mm   |           |
| 10C5-8RMPB  | 7236-03035 | 1/2 | 12.7 | 1/2-14   | 7/8    | —  | 2.88 | 73.2 | 1.59 | 40.4 | 1         |
| 12C5-12RMPB | 7236-03045 | 5/8 | 15.9 | 3/4-14   | 1 1/16 | —  | 3.26 | 82.8 | 1.69 | 42.9 | 1         |
| 16C5-16RMPB | 7236-03065 | 7/8 | 22.2 | 1-11 1/2 | 1 3/8  | —  | 2.91 | 73.9 | 1.72 | 43.7 | 1         |

## Male JIC 37° Flare - Steel

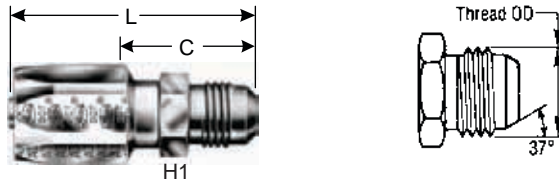

| Descr.               | Prod. No.  | ⊖     |      |           | H1     | H2 | L    |      | C    |      | Std. Pack |
|----------------------|------------|-------|------|-----------|--------|----|------|------|------|------|-----------|
|                      |            | "     | mm   |           |        |    | "    | mm   | "    | mm   |           |
| <b>STANDARD PACK</b> |            |       |      |           |        |    |      |      |      |      |           |
| 4C5-4RMJ             | 7236-86431 | 3/16  | 4.8  | 7/16-20   | 1/2    | —  | 1.79 | 45.5 | 1.09 | 27.7 | 1         |
| 5C5-5RMJ             | 7236-86432 | 1/4   | 6.4  | 1/2-20    | 1/2    | —  | 1.96 | 49.8 | 1.19 | 30.2 | 1         |
| 6C5-6RMJ             | 7236-86433 | 5/16  | 7.9  | 9/16-18   | 9/16   | —  | 2.17 | 55.1 | 1.22 | 31.0 | 1         |
| 8C5-8RMJ             | 7236-86434 | 13/32 | 10.3 | 3/4-16    | 3/4    | —  | 2.56 | 65.0 | 1.44 | 36.6 | 1         |
| 10C5-10RMJ           | 7236-86435 | 1/2   | 12.7 | 7/8-14    | 7/8    | —  | 2.88 | 73.2 | 1.59 | 40.4 | 1         |
| 12C5-12RMJ           | 7236-86436 | 5/8   | 15.9 | 1 1/16-12 | 1 1/16 | —  | 3.34 | 84.8 | 1.78 | 45.2 | 1         |
| 16C5-16RMJ           | 7236-86437 | 7/8   | 22.2 | 1 5/16-12 | 1 5/16 | —  | 2.87 | 73.0 | 1.69 | 42.9 | 1         |

## Female JIC 37° Flare Swivel - Steel

DOT FMVSS 106-74 Type All.

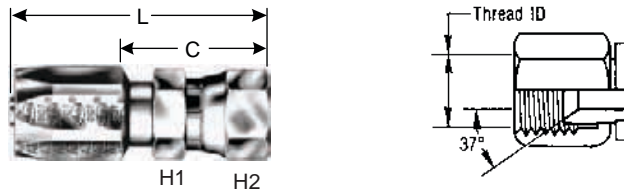

| Descr.               | Prod. No.  | ⊖       |      |           | H1    | H2    | L    |       | C    |      | Std. Pack |
|----------------------|------------|---------|------|-----------|-------|-------|------|-------|------|------|-----------|
|                      |            | "       | mm   |           |       |       | "    | mm    | "    | mm   |           |
| <b>STANDARD PACK</b> |            |         |      |           |       |       |      |       |      |      |           |
| 6C5-6RFJX            | 7238-86443 | 5/16    | 7.9  | 9/16-18   | 3/4   | 3/4   | 2.39 | 60.7  | 1.44 | 36.6 | 1         |
| 8C5-6RFJX            | 7238-04305 | 13/32   | 10.3 | 9/16-18   | 3/4   | 3/4   | 2.66 | 67.6  | 1.54 | 39.1 | 1         |
| 10C5-12RFJX          | 7238-04325 | 1/2     | 12.7 | 1 1/16-12 | 1 1/4 | 1 1/4 | 3.22 | 81.8  | 1.93 | 49.0 | 1         |
| 12C5-12RFJX          | 7238-86446 | 5/8     | 15.9 | 1 1/8-12  | 1 1/4 | 1 1/4 | 3.50 | 88.9  | 1.94 | 49.3 | 1         |
| 16C5-16RFJX          | 7238-86447 | 7/8     | 22.2 | 1 5/16-12 | 1 1/2 | 1 1/2 | 3.12 | 79.2  | 1.94 | 49.3 | 1         |
| 20C5-20RFJX          | 7238-86394 | 1 1/8   | 28.6 | 1 5/8-12  | 2     | 2     | 3.56 | 90.4  | 2.19 | 55.6 | 1         |
| 24C5-24RFJX          | 7238-86395 | 1 3/8   | 34.9 | 1 7/8-12  | 2 1/4 | 2 1/4 | 3.79 | 96.3  | 2.37 | 60.2 | 1         |
| 32C5-32RFJX          | 7238-86396 | 1 13/16 | 46.0 | 2 1/2-12  | 2 1/2 | 2 7/8 | 4.99 | 126.7 | 2.72 | 69.1 | 1         |



# Field Attachable for C5C, C5D & C5M Hose



## Female JIC 37° Flare Swivel - Brass

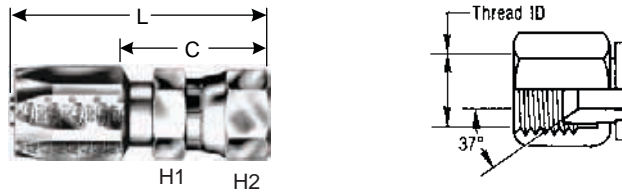

| Descr.               | Prod. No.  | ⊖    |      | 🌀         | H1    | H2    | L    |      | C    |      | Std. Pack |
|----------------------|------------|------|------|-----------|-------|-------|------|------|------|------|-----------|
|                      |            | "    | mm   |           |       |       | "    | mm   | "    | mm   |           |
| <b>STANDARD PACK</b> |            |      |      |           |       |       |      |      |      |      |           |
| 6C5-6RFJXB           | 7238-04075 | 5/16 | 7.9  | 9/16-18   | 3/4   | 3/4   | 2.39 | 60.7 | 1.44 | 36.6 | 1         |
| 12C5-12RFJXB         | 7238-04085 | 5/8  | 15.9 | 1 1/16-12 | 1 1/4 | 1 1/4 | 3.50 | 88.9 | 1.94 | 49.3 | 1         |
| 16C5-16RFJXB         | 7238-04095 | 7/8  | 22.2 | 1 5/16-12 | 1 1/2 | 1 1/2 | 3.12 | 79.2 | 1.94 | 49.3 | 1         |

## Female JIC 37° Flare Swivel - 45° Bent Tube - Steel

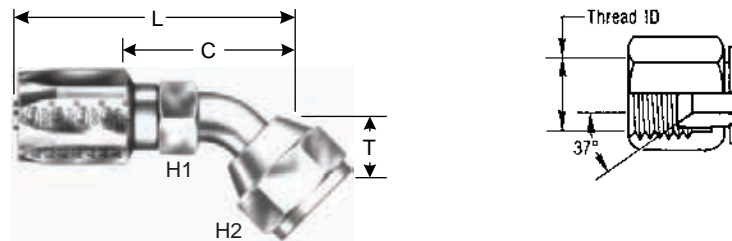

| Descr.               | Prod. No.  | ⊖    |      | 🌀         | H1    | H2    | T   | L    |      | C     |      | Std. Pack |   |
|----------------------|------------|------|------|-----------|-------|-------|-----|------|------|-------|------|-----------|---|
|                      |            | "    | mm   |           |       |       |     | "    | mm   | "     | mm   |           |   |
| <b>STANDARD PACK</b> |            |      |      |           |       |       |     |      |      |       |      |           |   |
| 6C5-6RFJX45          | 7235-86464 | 5/16 | 7.9  | 9/16-18   | 1/2   | 11/16 | .41 | 10.4 | 2.40 | 61.0  | 1.45 | 36.8      | 1 |
| 12C5-12RFJX45        | 7235-86467 | 5/8  | 15.9 | 1 1/16-12 | 7/8   | 1 1/4 | .78 | 19.8 | 4.27 | 108.5 | 2.71 | 68.8      | 1 |
| 16C5-16RFJX45        | 7235-86468 | 7/8  | 22.2 | 1 5/16-12 | 1 1/8 | 1 1/2 | .88 | 22.4 | 4.03 | 102.4 | 2.84 | 72.1      | 1 |

EQUIPMENT

HOSE/CPLG. SELECTION

GLOBALSPIRAL COUPLINGS

PCM/PCS FERRULES

MEGACRIMP COUPLINGS

POWER CRIMP COUPLINGS

LOW PRESSURE COUPLINGS

POLARSEAL COUPLINGS

C14 COUPLINGS

PCTS THERMO-PLASTIC COUPLINGS

FIELD ATTACHABLE G1 & G2 COUPLINGS

FIELD ATTACHABLE C5 COUPLINGS

SURELOK AIR BRAKE COUPLINGS

QUICK DISCONNECT COUPLERS

NEW BALL VALVES

ACCESSORIES

EQUIPMENT AND PARTS



The World's Most Trusted Name in Belts, Hose and Hydraulics.

[www.gates.com/hydraulics](http://www.gates.com/hydraulics)

M3



# Field Attachable for C5C, C5D & C5M Hose

## Female JIC 37° Flare Swivel - 90° Bent Tube - Steel

DOT FMVSS 106-74 Type All.

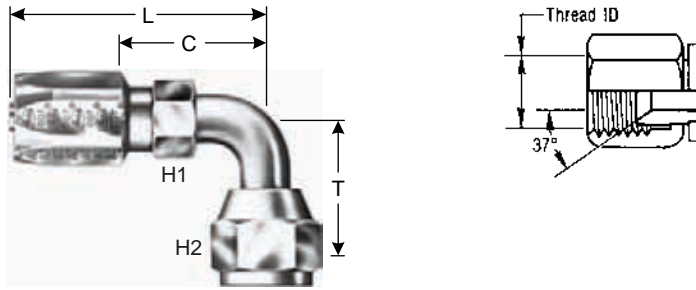

| Descr.               | Prod. No.  | ⊖     |      | 🌀         | H1    | H2    | T    |      | L    |       | C    |      | Std. Pack |
|----------------------|------------|-------|------|-----------|-------|-------|------|------|------|-------|------|------|-----------|
|                      |            | "     | mm   |           | "     | "     | "    | mm   | "    | mm    | "    | mm   |           |
| <b>STANDARD PACK</b> |            |       |      |           |       |       |      |      |      |       |      |      |           |
| 6C5-6RFJX90          | 7235-86471 | 5/16  | 7.9  | 9/16-18   | 1/2   | 11/16 | .84  | 21.3 | 2.28 | 57.9  | 1.33 | 33.8 | 1         |
| 12C5-12RFJX90        | 7235-86474 | 5/8   | 15.9 | 1 1/16-12 | 7/8   | 1 1/4 | 1.81 | 46.0 | 4.22 | 107.2 | 2.66 | 67.6 | 1         |
| 16C5-16RFJX90        | 7235-86475 | 7/8   | 22.2 | 1 5/16-12 | 1 1/8 | 1 1/2 | 2.16 | 54.9 | 3.95 | 100.3 | 2.76 | 70.1 | 1         |
| 20C5-20RFJX90S       | 7235-20265 | 1 1/8 | 28.6 | 1 5/8-12  | 1 3/8 | 2     | 2.75 | 69.8 | 5.07 | 128.8 | 3.70 | 94.0 | 1         |
| <b>BULK PACK</b>     |            |       |      |           |       |       |      |      |      |       |      |      |           |
| 20C5-20RFJX90SXBULK  | 7235-2026  | 1 1/8 | 28.6 | 1 5/8-12  | 1 3/8 | 2     | 2.75 | 69.8 | 5.07 | 128.8 | 3.70 | 94.0 | 20        |

## Female JIC 37° Flare Swivel - 90° Long Bent Tube - Steel

DOT FMVSS 106-74 Type All.

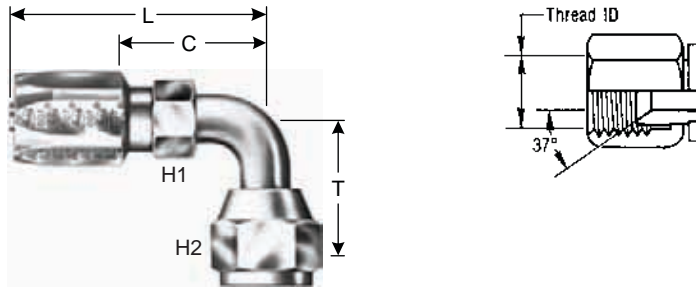

| Descr.               | Prod. No.  | ⊖     |      | 🌀         | H1    | H2    | T    |       | L    |       | C    |      | Std. Pack |
|----------------------|------------|-------|------|-----------|-------|-------|------|-------|------|-------|------|------|-----------|
|                      |            | "     | mm   |           | "     | "     | "    | mm    | "    | mm    | "    | mm   |           |
| <b>STANDARD PACK</b> |            |       |      |           |       |       |      |       |      |       |      |      |           |
| 6C5-6RFJX90L         | 7235-04205 | 5/16  | 7.9  | 9/16-18   | 1/2   | 11/16 | 2.19 | 55.6  | 2.28 | 57.9  | 1.33 | 33.8 | 1         |
| 12C5-12RFJX90L       | 7235-86481 | 5/8   | 15.9 | 1 1/16-12 | 7/8   | 1 1/4 | 3.75 | 95.2  | 4.22 | 107.2 | 2.66 | 67.6 | 1         |
| 16C5-16RFJX90L       | 7235-86482 | 7/8   | 22.2 | 1 5/16-12 | 1 1/8 | 1 1/2 | 4.34 | 110.2 | 3.95 | 100.3 | 2.76 | 70.1 | 1         |
| 20C5-20RFJX90L       | 7235-20255 | 1 1/8 | 28.6 | 1 5/8-12  | 1 3/8 | 2     | 5.50 | 139.7 | 5.26 | 133.6 | 3.89 | 98.8 | 1         |



# Field Attachable for C5C, C5D & C5M Hose



## Male SAE 45° Flare - Steel

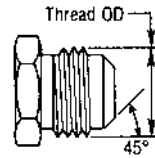
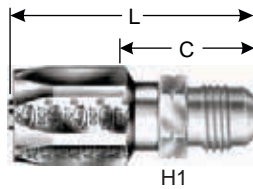

| Descr.               | Prod. No.  | ⊖     |      |  | H1     | H2 | L    |      | C    |      | Std. Pack |
|----------------------|------------|-------|------|---|--------|----|------|------|------|------|-----------|
|                      |            | "     | mm   |   |        |    | "    | mm   | "    | mm   |           |
| <b>STANDARD PACK</b> |            |       |      |   |        |    |      |      |      |      |           |
| 4C5-4RMS             | 7236-86414 | 3/16  | 4.8  | 1/2-20  | 1/2    | —  | 1.76 | 44.7 | 1.06 | 26.9 | 1         |
| 5C5-5RMS             | 7236-86415 | 1/4   | 6.4  | 1/2-20  | 1/2    | —  | 1.96 | 49.8 | 1.19 | 30.2 | 1         |
| 6C5-6RMS             | 7236-86416 | 5/16  | 7.9  | 5/8-18  | 5/8    | —  | 2.23 | 56.6 | 1.28 | 32.5 | 1         |
| 8C5-8RMS             | 7236-86417 | 13/32 | 10.3 | 3/4-16  | 3/4    | —  | 2.65 | 67.3 | 1.53 | 38.9 | 1         |
| 10C5-10RMS           | 7236-86418 | 1/2   | 12.7 | 7/8-14  | 7/8    | —  | 3.01 | 76.5 | 1.72 | 43.7 | 1         |
| 12C5-12RMS           | 7236-86419 | 5/8   | 15.9 | 1 1/16-14   | 1 1/16 | —  | 3.50 | 88.9 | 1.94 | 49.3 | 1         |

## Male SAE 45° Flare Inverted Swivel - Steel

DOT FMVSS 106-74 Type All.

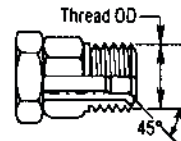
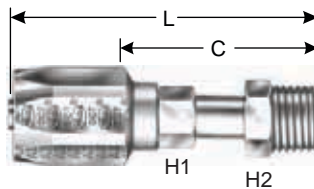

| Descr.               | Prod. No.  | ⊖     |      |  | H1   | H2   | L    |      | C    |      | Std. Pack |
|----------------------|------------|-------|------|---|------|------|------|------|------|------|-----------|
|                      |            | "     | mm   |   |      |      | "    | mm   | "    | mm   |           |
| <b>STANDARD PACK</b> |            |       |      |   |      |      |      |      |      |      |           |
| 4C5-4RMIX            | 7235-86372 | 3/16  | 4.8  | 7/16-24   | 7/16 | 7/16 | 2.41 | 61.2 | 1.72 | 43.7 | 1         |
| 5C5-5RMIX            | 7235-86381 | 1/4   | 6.4  | 1/2-20  | 7/16 | 1/2  | 2.63 | 66.8 | 1.84 | 46.7 | 1         |
| 5C5-6RMIX            | 7235-01025 | 5/16  | 6.4  | 5/8-18  | 1/2  | 5/8  | 2.59 | 65.8 | 1.82 | 46.2 | 1         |
| 6C5-5RMIX            | 7235-01035 | 5/16  | 7.9  | 1/2-20  | 1/2  | 1/2  | 2.60 | 66.0 | 1.65 | 41.9 | 1         |
| 6C5-6RMIX            | 7235-86382 | 5/16  | 7.9  | 5/8-18  | 1/2  | 5/8  | 2.86 | 72.6 | 1.91 | 48.5 | 1         |
| 6C5-8RMIX            | 7235-01055 | 3/8   | 7.9  | 3/4-16  | 5/8  | 3/4  | 3.23 | 82.0 | 2.28 | 57.9 | 1         |
| 8C5-6RMIX            | 7235-01065 | 13/32 | 10.3 | 5/8-18  | 5/8  | 5/8  | 3.13 | 79.5 | 2.01 | 51.0 | 1         |
| 8C5-8RMIX            | 7235-01075 | 1/2   | 10.3 | 3/4-16  | 5/8  | 3/4  | 3.49 | 88.6 | 2.37 | 60.2 | 1         |

|                                    |
|------------------------------------|
| EQUIPMENT                          |
| HOSE/CPLG. SELECTION               |
| GLOBALSPIRAL COUPLINGS             |
| PCM/PCS FERRULES                   |
| MEGACRIMP COUPLINGS                |
| POWER CRIMP COUPLINGS              |
| LOW PRESSURE COUPLINGS             |
| POLARSEAL COUPLINGS                |
| C14 COUPLINGS                      |
| PCTS THERMO-PLASTIC COUPLINGS      |
| FIELD ATTACHABLE G1 & G2 COUPLINGS |
| FIELD ATTACHABLE C5 COUPLINGS      |
| SURELOK AIR BRAKE COUPLINGS        |
| QUICK DISCONNECT COUPLERS          |
| NEW BALL VALVES                    |
| ACCESSORIES                        |
| EQUIPMENT AND PARTS                |



# Field Attachable for C5C, C5D & C5M Hose

## Male SAE 45° Flare Inverted Swivel - 45° Bent Tube - Steel

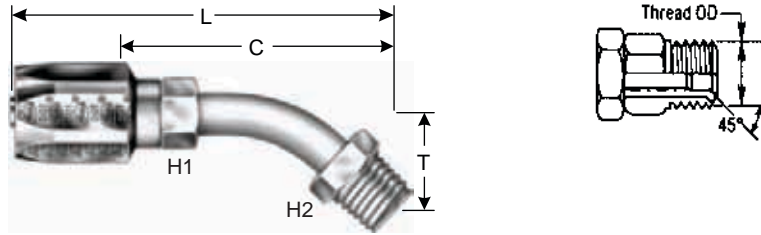

| Descr.               | Prod. No.  | ⊖     |      | 🌀       | H1   | H2   | T    |      | L    |      | C    |      | Std. Pack |
|----------------------|------------|-------|------|---------|------|------|------|------|------|------|------|------|-----------|
|                      |            | "     | mm   |         | "    | "    | "    | mm   | "    | mm   | "    | mm   |           |
| <b>STANDARD PACK</b> |            |       |      |         |      |      |      |      |      |      |      |      |           |
| 4C5-4RMIX45          | 7235-05005 | 3/16  | 4.8  | 7/16-24 | 7/16 | 7/16 | .62  | 15.7 | 2.18 | 55.4 | 1.48 | 37.6 | 1         |
| 6C5-6RMIX45          | 7235-05015 | 5/16  | 7.9  | 5/8-18  | 1/2  | 5/8  | .94  | 23.9 | 3.03 | 77.0 | 2.09 | 53.1 | 1         |
| 8C5-8RMIX45          | 7235-05025 | 13/32 | 10.3 | 1/2-14  | 5/8  | 3/4  | 1.09 | 27.7 | 3.44 | 87.4 | 2.32 | 58.9 | 1         |

## Male SAE 45° Flare Inverted Swivel - 90° Bent Tube - Steel

DOT FMVSS 106-74 Type All.

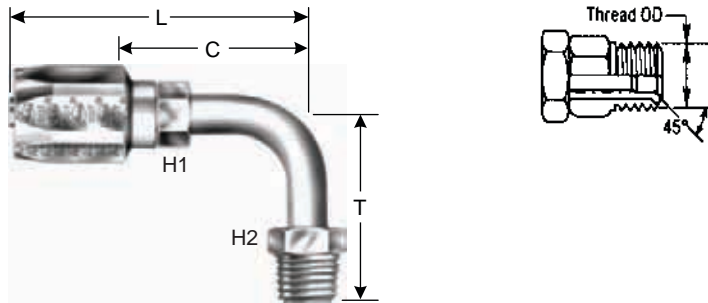

| Descr.               | Prod. No.  | ⊖     |      | 🌀       | H1   | H2   | T    |      | L    |      | C    |      | Std. Pack |
|----------------------|------------|-------|------|---------|------|------|------|------|------|------|------|------|-----------|
|                      |            | "     | mm   |         | "    | "    | "    | mm   | "    | mm   | "    | mm   |           |
| <b>STANDARD PACK</b> |            |       |      |         |      |      |      |      |      |      |      |      |           |
| 4C5-4RMIX90          | 7235-05105 | 3/16  | 4.8  | 7/16-24 | 7/16 | 7/16 | 1.56 | 39.6 | 2.17 | 55.1 | 1.47 | 37.3 | 1         |
| 5C5-5RMIX90          | 7235-86386 | 1/4   | 6.4  | 1/2-20  | 7/16 | 1/2  | 1.66 | 42.2 | 2.43 | 61.7 | 1.66 | 42.2 | 1         |
| 6C5-6RMIX90          | 7235-86387 | 5/16  | 7.9  | 5/8-18  | 1/2  | 5/8  | 1.69 | 42.9 | 2.64 | 67.0 | 1.69 | 42.9 | 1         |
| 6C5-8RMIX90          | 7235-05135 | 3/8   | 7.9  | 3/4-16  | 5/8  | 3/4  | 1.78 | 45.2 | 2.73 | 69.3 | 1.78 | 45.2 | 1         |
| 8C5-6RMIX90          | 7235-05145 | 13/32 | 10.3 | 5/8-18  | 5/8  | 5/8  | 1.69 | 42.9 | 2.81 | 71.4 | 1.69 | 42.9 | 1         |
| 8C5-8RMIX90          | 7235-05155 | 1/2   | 10.3 | 1/2-14  | 5/8  | 3/4  | 1.78 | 45.2 | 2.90 | 73.7 | 1.78 | 45.2 | 1         |

- EQUIPMENT
- HOSE/CPLG. SELECTION
- GLOBALSPIRAL COUPLINGS
- PCM/PCS FERRULES
- MEGACRIMP COUPLINGS
- POWER CRIMP COUPLINGS
- LOW PRESSURE COUPLINGS
- POLARSEAL COUPLINGS
- C14 COUPLINGS
- PCTS THERMO-PLASTIC COUPLINGS
- FIELD ATTACHABLE G1 & G2 COUPLINGS
- FIELD ATTACHABLE C5 COUPLINGS
- SURELOK AIR BRAKE COUPLINGS
- QUICK DISCONNECT COUPLERS
- NEW BALL VALVES
- ACCESSORIES
- EQUIPMENT AND PARTS



# Field Attachable for C5C, C5D & C5M Hose



## Female SAE 45° Flare Swivel - Steel

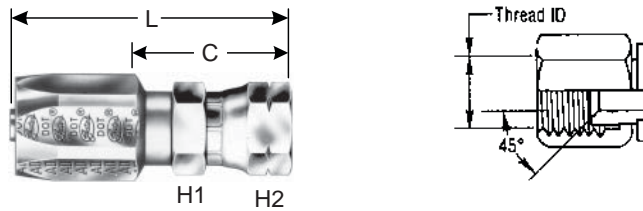

| Descr.               | Prod. No.  | ⊖    |      |           | H1    | H2    | L    |      | C    |      | Std. Pack |
|----------------------|------------|------|------|-----------|-------|-------|------|------|------|------|-----------|
|                      |            | "    | mm   |           |       |       | "    | mm   | "    | mm   |           |
| <b>STANDARD PACK</b> |            |      |      |           |       |       |      |      |      |      |           |
| 6C5-6RFSX            | 7238-04235 | 5/16 | 7.9  | 5/8-18    | 3/4   | 3/4   | 2.42 | 61.5 | 1.47 | 37.3 | 5         |
| 10C5-12RFSX          | 7238-04335 | 1/2  | 12.7 | 1 1/16-14 | 1 1/4 | 1 1/4 | 3.22 | 81.8 | 1.93 | 49.0 | 1         |
| 12C5-12RFSX          | 7238-04265 | 5/8  | 15.9 | 1 1/16-14 | 1 1/4 | 1 1/4 | 3.50 | 88.9 | 1.94 | 49.3 | 1         |

## Female SAE 45° Flare Swivel - Brass

DOT FMVSS 106-74 Type All.

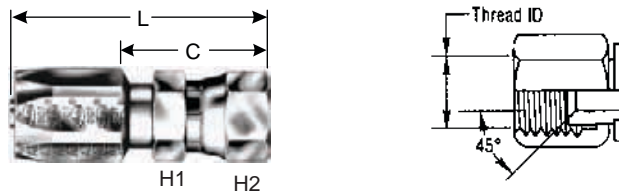

| Descr.               | Prod. No.  | ⊖    |      |           | H1    | H2    | L    |      | C    |      | Std. Pack |
|----------------------|------------|------|------|-----------|-------|-------|------|------|------|------|-----------|
|                      |            | "    | mm   |           |       |       | "    | mm   | "    | mm   |           |
| <b>STANDARD PACK</b> |            |      |      |           |       |       |      |      |      |      |           |
| 6C5-6RFSXB           | 7238-04045 | 5/16 | 7.9  | 5/8-18    | 3/4   | 3/4   | 2.42 | 61.5 | 1.47 | 37.3 | 1         |
| 12C5-12RFSXB         | 7238-04055 | 5/8  | 15.9 | 1 1/16-14 | 1 1/4 | 1 1/4 | 3.50 | 88.9 | 1.94 | 49.3 | 1         |

## Female SAE 45° Flare Swivel - 45° Bent Tube - Steel

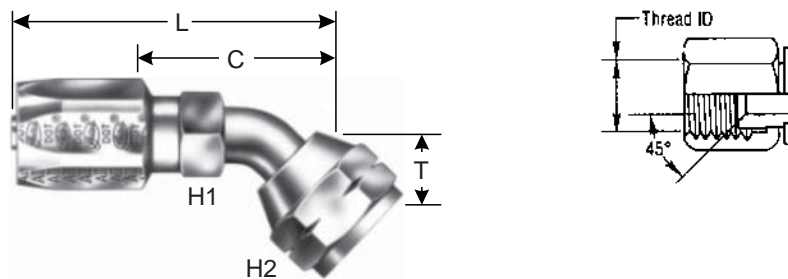

| Descr.               | Prod. No.  | ⊖    |      |           | H1  | H2    | T   |      | L    |       | C    |      | Std. Pack |
|----------------------|------------|------|------|-----------|-----|-------|-----|------|------|-------|------|------|-----------|
|                      |            | "    | mm   |           |     |       | "   | mm   | "    | mm    | "    | mm   |           |
| <b>STANDARD PACK</b> |            |      |      |           |     |       |     |      |      |       |      |      |           |
| 6C5-6RFSX45          | 7235-04855 | 5/16 | 7.9  | 5/8-18    | 1/2 | 3/4   | .41 | 10.4 | 2.42 | 61.5  | 1.47 | 37.3 | 1         |
| 12C5-12RFSX45        | 7235-04885 | 5/8  | 15.9 | 1 1/16-14 | 7/8 | 1 1/4 | .74 | 18.8 | 4.27 | 108.5 | 2.71 | 68.8 | 1         |

EQUIPMENT

HOSE/CPLG. SELECTION

GLOBALSPIRAL COUPLINGS

PCM/PCS FERRULES

MEGACRIMP COUPLINGS

POWER CRIMP COUPLINGS

LOW PRESSURE COUPLINGS

POLARSEAL COUPLINGS

C14 COUPLINGS

PCTS THERMO-PLASTIC COUPLINGS

FIELD ATTACHABLE G1 & G2 COUPLINGS

FIELD ATTACHABLE C5 COUPLINGS

SURELOK AIR BRAKE COUPLINGS

QUICK DISCONNECT COUPLERS

NEW BALL VALVES

ACCESSORIES

EQUIPMENT AND PARTS



The World's Most Trusted Name in Belts, Hose and Hydraulics.

[www.gates.com/hydraulics](http://www.gates.com/hydraulics)

M7



# Field Attachable for C5C, C5D & C5M Hose

## Female SAE 45° Flare Swivel - 90° Bent Tube - Steel

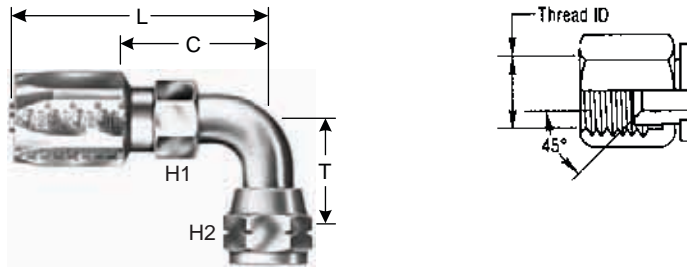

| Descr.               | Prod. No.  | ⊖    |      | 🌀         | H1  | H2    | T    |      | L    |       | C    |      | Std. Pack |
|----------------------|------------|------|------|-----------|-----|-------|------|------|------|-------|------|------|-----------|
|                      |            | "    | mm   |           | "   | "     | "    | mm   | "    | mm    | "    | mm   |           |
| <b>STANDARD PACK</b> |            |      |      |           |     |       |      |      |      |       |      |      |           |
| 6C5-6RFSX90          | 7235-04915 | 5/16 | 7.9  | 5/8-18    | 1/2 | 3/4   | .84  | 21.3 | 2.28 | 57.9  | 1.33 | 33.8 | 1         |
| 6C5-6RFSX90L         | 7235-86497 | 5/16 | 7.9  | 5/8-18    | 1/2 | 3/4   | 2.19 | 55.6 | 2.28 | 57.9  | 1.22 | 31.0 | 1         |
| 12C5-12RFSX90        | 7235-04945 | 5/8  | 15.9 | 1 1/16-14 | 7/8 | 1 1/4 | 1.81 | 46.0 | 4.72 | 119.9 | 2.66 | 67.6 | 1         |
| 12C5-12RFSX90L       | 7235-86376 | 5/8  | 15.9 | 1 1/16-14 | 7/8 | 1 1/4 | 3.75 | 95.2 | 4.22 | 107.2 | 2.16 | 54.9 | 1         |

## Dual Seat Female JIC 37°/SAE 45° Flare Swivel - Steel

DOT FMVSS 106-74 Type All.

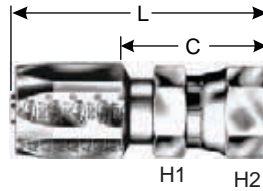

| Descr.               | Prod. No.  | ⊖     |      | 🌀       | H1     | H2     | L    |      | C    |      | Std. Pack |
|----------------------|------------|-------|------|---------|--------|--------|------|------|------|------|-----------|
|                      |            | "     | mm   |         | "      | "      | "    | mm   | "    | mm   |           |
| <b>STANDARD PACK</b> |            |       |      |         |        |        |      |      |      |      |           |
| 4C5-4RFJSX           | 7238-04215 | 3/16  | 4.8  | 7/16-20 | 9/16   | 9/16   | 1.92 | 48.8 | 1.22 | 31.0 | 5         |
| 5C5-4RFJSX           | 7238-04275 | 1/4   | 6.4  | 7/16-20 | 9/16   | 9/16   | 2.05 | 52.1 | 1.28 | 32.5 | 1         |
| 5C5-5RFJSX           | 7238-04225 | 1/4   | 6.4  | 1/2-20  | 11/16  | 11/16  | 2.11 | 53.6 | 1.34 | 34.0 | 1         |
| 6C5-8RFJSX           | 7238-04295 | 5/16  | 7.9  | 3/4-16  | 7/8    | 7/8    | 2.48 | 63.0 | 1.53 | 38.9 | 1         |
| 8C5-8RFJSX           | 7238-04245 | 13/32 | 10.3 | 3/4-16  | 7/8    | 7/8    | 2.75 | 69.8 | 1.63 | 41.4 | 5         |
| 10C5-8RFJSX          | 7238-04315 | 1/2   | 12.7 | 3/4-16  | 7/8    | 7/8    | 2.93 | 74.4 | 1.64 | 41.6 | 1         |
| 10C5-10RFJSX         | 7238-04255 | 1/2   | 12.7 | 7/8-14  | 1 1/16 | 1 1/16 | 3.10 | 78.7 | 1.81 | 46.0 | 5         |
| <b>BULK PACK</b>     |            |       |      |         |        |        |      |      |      |      |           |
| 4C5-4RFJSX XBULK     | 7238-0421  | 3/16  | 4.8  | 7/16-20 | 9/16   | 9/16   | 1.92 | 48.8 | 1.22 | 31.0 | 100       |
| 5C5-5RFJSX XBULK     | 7238-0422  | 1/4   | 6.4  | 1/2-20  | 11/16  | 11/16  | 2.11 | 53.6 | 1.34 | 34.0 | 125       |
| 8C5-8RFJSX XBULK     | 7238-0424  | 13/32 | 10.3 | 3/4-16  | 7/8    | 7/8    | 2.75 | 69.8 | 1.63 | 41.4 | 100       |
| 10C5-8RFJSX XBULK    | 7238-0431  | 1/2   | 12.7 | 3/4-16  | 7/8    | 7/8    | 2.93 | 74.4 | 1.64 | 41.6 | 80        |



# Field Attachable for C5C, C5D & C5M Hose



## Dual Seat Female JIC 37°/SAE 45° Flare Swivel - 45° Bent Tube - Steel

DOT FMVSS 106-74 Type All.

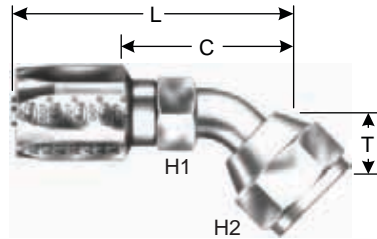

| Descr.               | Prod. No.  | ⊖     |      |         | H1   | H2   | T   | L    |      | C    |      | Std. Pack |   |
|----------------------|------------|-------|------|---------|------|------|-----|------|------|------|------|-----------|---|
|                      |            | "     | mm   |         |      |      |     | "    | mm   | "    | mm   |           |   |
| <b>STANDARD PACK</b> |            |       |      |         |      |      |     |      |      |      |      |           |   |
| 4C5-4RFJSX45         | 7235-20005 | 3/16  | 4.8  | 7/16-20 | 7/16 | 9/16 | .34 | 8.6  | 1.90 | 48.3 | 1.21 | 30.7      | 1 |
| 5C5-5RFJSX45         | 7235-20015 | 1/4   | 6.4  | 1/2-20  | 7/16 | 5/8  | .38 | 9.7  | 2.11 | 53.6 | 1.34 | 34.0      | 1 |
| 6C5-8RFJSX45         | 7235-20045 | 5/16  | 7.9  | 3/4-16  | 5/8  | 7/8  | .56 | 14.2 | 2.71 | 68.8 | 1.76 | 44.7      | 1 |
| 8C5-8RFJSX45         | 7235-20025 | 13/32 | 10.3 | 3/4-16  | 5/8  | 7/8  | .56 | 14.2 | 2.98 | 75.7 | 1.86 | 47.2      | 1 |
| 10C5-10RFJSX45       | 7235-20035 | 1/2   | 12.7 | 7/8-14  | 3/4  | 1    | .63 | 16.0 | 3.60 | 91.4 | 2.31 | 58.7      | 1 |

## Dual Seat Female JIC 37°/SAE 45° Flare Swivel - 90° Bent Tube - Steel

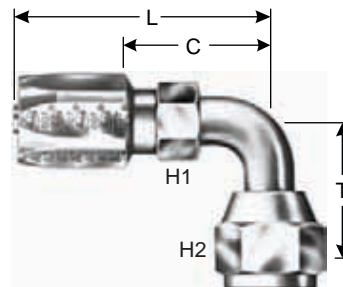

| Descr.               | Prod. No.  | ⊖     |      |         | H1   | H2   | T    | L    |      | C    |      | Std. Pack |   |
|----------------------|------------|-------|------|---------|------|------|------|------|------|------|------|-----------|---|
|                      |            | "     | mm   |         |      |      |      | "    | mm   | "    | mm   |           |   |
| <b>STANDARD PACK</b> |            |       |      |         |      |      |      |      |      |      |      |           |   |
| 4C5-4RFJSX90         | 7235-20105 | 3/16  | 4.8  | 7/16-20 | 7/16 | 9/16 | .69  | 17.5 | 1.78 | 45.2 | 1.08 | 27.4      | 1 |
| 4C5-4RFJSX90L        | 7235-20205 | 3/16  | 4.8  | 7/16-20 | 7/16 | 9/16 | 1.81 | 46.0 | 1.78 | 45.2 | 1.08 | 27.4      | 1 |
| 5C5-5RFJSX90         | 7235-20115 | 1/4   | 6.4  | 1/2-20  | 7/16 | 5/8  | .78  | 19.8 | 2.02 | 51.3 | 1.25 | 31.8      | 1 |
| 5C5-5RFJSX90L        | 7235-20215 | 1/4   | 6.4  | 1/2-20  | 7/16 | 5/8  | 1.78 | 45.2 | 2.02 | 51.3 | 1.25 | 31.8      | 1 |
| 8C5-8RFJSX90         | 7235-20125 | 13/32 | 10.3 | 3/4-16  | 5/8  | 7/8  | 1.09 | 27.7 | 2.79 | 70.9 | 1.67 | 42.4      | 1 |
| 8C5-8RFJSX90L        | 7235-20225 | 13/32 | 10.3 | 3/4-16  | 5/8  | 7/8  | 2.44 | 62.0 | 2.79 | 70.9 | 1.67 | 42.4      | 1 |
| 10C5-10RFJSX90       | 7235-20135 | 1/2   | 12.7 | 7/8-14  | 3/4  | 1    | 1.25 | 31.8 | 3.41 | 86.6 | 2.12 | 53.8      | 1 |
| 10C5-10RFJSX90L      | 7235-20235 | 1/2   | 12.7 | 7/8-14  | 3/4  | 1    | 2.56 | 65.0 | 3.41 | 86.6 | 2.12 | 53.8      | 1 |

|                                    |
|------------------------------------|
| EQUIPMENT                          |
| HOSE/CPLG. SELECTION               |
| GLOBALSPIRAL COUPLINGS             |
| PCM/PCS FERRULES                   |
| MEGACRIMP COUPLINGS                |
| POWER CRIMP COUPLINGS              |
| LOW PRESSURE COUPLINGS             |
| POLARSEAL COUPLINGS                |
| C14 COUPLINGS                      |
| PCTS THERMO-PLASTIC COUPLINGS      |
| FIELD ATTACHABLE G1 & G2 COUPLINGS |
| FIELD ATTACHABLE C5 COUPLINGS      |
| SURELOK AIR BRAKE COUPLINGS        |
| QUICK DISCONNECT COUPLERS          |
| NEW BALL VALVES                    |
| ACCESSORIES                        |
| EQUIPMENT AND PARTS                |



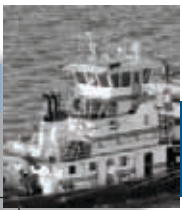

# Field Attachable for C5C, C5D & C5M Hose

EQUIPMENT

HOSE/CPLG. SELECTION

GLOBALSPIRAL COUPLINGS

PCM/PCS FERRULES

MEGACRIMP COUPLINGS

POWER CRIMP COUPLINGS

LOW PRESSURE COUPLINGS

POLARSEAL COUPLINGS

C14 COUPLINGS

PCTS THERMO-PLASTIC COUPLINGS

FIELD ATTACHABLE G1 & G2 COUPLINGS

FIELD ATTACHABLE C5 COUPLINGS

SURELOK AIR BRAKE COUPLINGS

QUICK DISCONNECT COUPLERS

NEW BALL VALVES

ACCESSORIES

EQUIPMENT AND PARTS

## Dual Seat Female JIC 37°/SAE 45° Flare Swivel - Brass

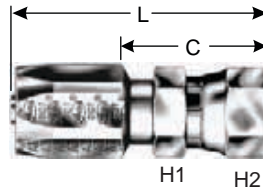

| Descr.               | Prod. No.  | ⊖     |      |        | H1     | H2     | L    |      | C    |      | Std. Pack |
|----------------------|------------|-------|------|--------|--------|--------|------|------|------|------|-----------|
|                      |            | "     | mm   |        | "      | "      | "    | mm   | "    | mm   |           |
| <b>STANDARD PACK</b> |            |       |      |        |        |        |      |      |      |      |           |
| 5C5-5RFJSXB          | 7238-04005 | 1/4   | 6.4  | 1/2-20 | 11/16  | 11/16  | 2.11 | 53.6 | 1.34 | 34.0 | 1         |
| 8C5-8RFJSXB          | 7238-04015 | 13/32 | 10.3 | 3/4-16 | 7/8    | 7/8    | 2.75 | 69.8 | 1.63 | 41.4 | 1         |
| 10C5-10RFJSXB        | 7238-04025 | 1/2   | 12.7 | 7/8-14 | 1 1/16 | 1 1/16 | 3.10 | 78.7 | 1.81 | 46.0 | 1         |

## Male O-Ring Boss - Steel

DOT FMVSS 106-74 Type All.

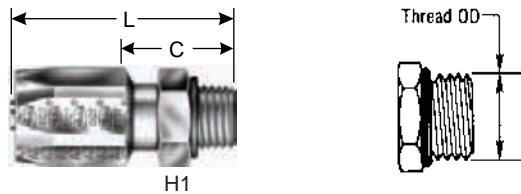

| Descr.               | Prod. No.  | ⊖     |      |         | H1    | H2 | L    |      | C    |      | Std. Pack |
|----------------------|------------|-------|------|---------|-------|----|------|------|------|------|-----------|
|                      |            | "     | mm   |         | "     | "  | "    | mm   | "    | mm   |           |
| <b>STANDARD PACK</b> |            |       |      |         |       |    |      |      |      |      |           |
| 4C5-4RMB             | 7236-86451 | 3/16  | 4.8  | 7/16-20 | 5/8   | —  | 1.66 | 42.2 | .94  | 23.9 | 1         |
| 6C5-6RMB             | 7236-86453 | 5/16  | 7.9  | 9/16-18 | 11/16 | —  | 2.00 | 50.8 | 1.05 | 26.7 | 1         |
| 8C5-8RMB             | 7236-86454 | 13/32 | 10.3 | 3/4-16  | 15/16 | —  | 2.35 | 59.7 | 1.19 | 30.2 | 1         |

## Female Flat-Face Swivel - Steel

DOT FMVSS 106-74 Type All.  
SAE J1453 O-Ring Face Seal.

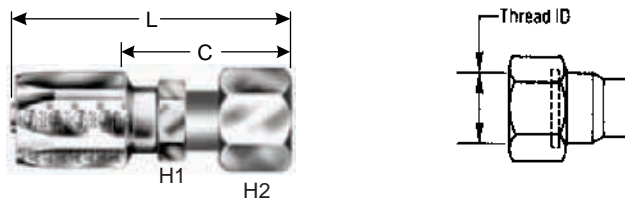

| Descr.               | Prod. No.  | ⊖     |      |          | H1    | H2    | L    |      | C    |      | Std. Pack |
|----------------------|------------|-------|------|----------|-------|-------|------|------|------|------|-----------|
|                      |            | "     | mm   |          | "     | "     | "    | mm   | "    | mm   |           |
| <b>STANDARD PACK</b> |            |       |      |          |       |       |      |      |      |      |           |
| 4C5-4RFFORX          | 7238-01505 | 3/16  | 4.8  | 9/16-18  | 9/16  | 11/16 | 2.07 | 52.6 | 1.32 | 33.5 | 1         |
| 6C5-6RFFORX          | 7238-01265 | 5/16  | 7.9  | 11/16-16 | 1/2   | 13/16 | 2.53 | 64.3 | 1.58 | 40.1 | 1         |
| 8C5-8RFFORX          | 7238-01535 | 13/32 | 10.3 | 13/16-16 | 13/16 | 15/16 | 2.92 | 74.3 | 1.77 | 45.1 | 1         |



# Field Attachable for C5C, C5D & C5M Hose



## Female Flat-Face Swivel - Steel - Cont'd

| Descr.        | Prod. No.  | ⊖   |      |           | H1    | H2    | L    |      | C    |      | Std. Pack |
|---------------|------------|-----|------|-----------|-------|-------|------|------|------|------|-----------|
|               |            | "   | mm   |           |       |       | "    | mm   | "    | mm   |           |
| 10C5-10RFFORX | 7238-01545 | 1/2 | 12.7 | 1-14      | 15/16 | 1 1/8 | 3.23 | 82.0 | 1.94 | 49.3 | 1         |
| 12C5-12RFFORX | 7238-01555 | 5/8 | 15.9 | 1 3/16-12 | 7/8   | 1 3/8 | 3.70 | 94.0 | 2.12 | 53.8 | 1         |

## Female Flat-Face Swivel - 45° Bent Tube - Steel

SAE J1453 O-Ring Face Seal.

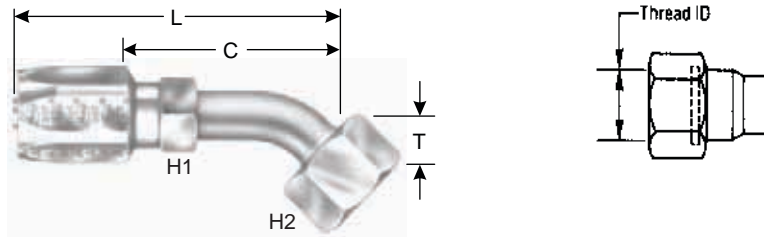

| Descr.               | Prod. No.  | ⊖    |     |         | H1  | H2    | T   | L    |      | C    |      | Std. Pack |   |
|----------------------|------------|------|-----|---------|-----|-------|-----|------|------|------|------|-----------|---|
|                      |            | "    | mm  |         |     |       |     | "    | mm   | "    | mm   |           |   |
| <b>STANDARD PACK</b> |            |      |     |         |     |       |     |      |      |      |      |           |   |
| 4C5-4RFFORX45        | 7235-05275 | 3/16 | 4.8 | 9/16-18 | 1/2 | 11/16 | .41 | 10.4 | 2.42 | 61.5 | 1.67 | 42.4      | 1 |

## Female Flat-Face Swivel - 90° Bent Tube - Steel

SAE J1453 O-Ring Face Seal.

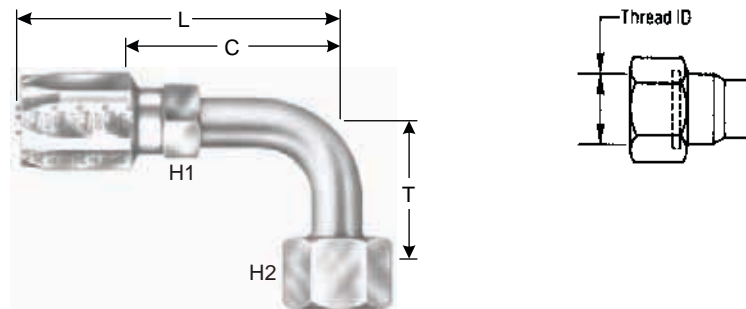

| Descr.               | Prod. No.  | ⊖    |     |        | H1  | H2    | T   | L    |      | C    |      | Std. Pack |   |
|----------------------|------------|------|-----|--------|-----|-------|-----|------|------|------|------|-----------|---|
|                      |            | "    | mm  |        |     |       |     | "    | mm   | "    | mm   |           |   |
| <b>STANDARD PACK</b> |            |      |     |        |     |       |     |      |      |      |      |           |   |
| 4C5-4RFFORX90        | 7235-05285 | 1/4  | 4.8 | 1/2-20 | 1/2 | 11/16 | .82 | 20.8 | 2.17 | 55.1 | 1.42 | 36.1      | 1 |
| 6C5-6RFFORX90S       | 7235-05305 | 5/16 | 7.9 | 5/8-18 | 1/2 | 13/16 | .90 | 22.9 | 2.77 | 70.3 | 1.82 | 46.2      | 1 |

EQUIPMENT

HOSE/CPLG. SELECTION

GLOBALSPIRAL COUPLINGS

PCM/PCS FERRULES

MEGACRIMP COUPLINGS

POWER CRIMP COUPLINGS

LOW PRESSURE COUPLINGS

POLARSEAL COUPLINGS

C14 COUPLINGS

PCTS THERMO-PLASTIC COUPLINGS

FIELD ATTACHABLE G1 & G2 COUPLINGS

FIELD ATTACHABLE C5 COUPLINGS

SURELOK AIR BRAKE COUPLINGS

QUICK DISCONNECT COUPLERS

NEW BALL VALVES

ACCESSORIES

EQUIPMENT AND PARTS



The World's Most Trusted Name in Belts, Hose and Hydraulics.

[www.gates.com/hydraulics](http://www.gates.com/hydraulics)

M11

# Field Attachable for C5C, C5D & C5M Hose

EQUIPMENT

HOSE/CPLG. SELECTION

GLOBALSPIRAL COUPLINGS

PCM/PCS FERRULES

MEGACRIMP COUPLINGS

POWER CRIMP COUPLINGS

LOW PRESSURE COUPLINGS

POLARSEAL COUPLINGS

C14 COUPLINGS

PCTS THERMO-PLASTIC COUPLINGS

FIELD ATTACHABLE G1 & G2 COUPLINGS

FIELD ATTACHABLE C5 COUPLINGS

SURELOK AIR BRAKE COUPLINGS

QUICK DISCONNECT COUPLERS

NEW BALL VALVES

ACCESSORIES

EQUIPMENT AND PARTS

## SAE Male Flareless Assembly - Steel



| Descr.               | Prod. No.  | ⊖     |      | 🌀       | H1    | H2    | L    |      | C    |      | Std. Pack |
|----------------------|------------|-------|------|---------|-------|-------|------|------|------|------|-----------|
|                      |            | "     | mm   |         | "     | "     | "    | mm   | "    | mm   |           |
| <b>STANDARD PACK</b> |            |       |      |         |       |       |      |      |      |      |           |
| 4C5-4RMFA            | 7236-04855 | 3/16  | 4.8  | 7/16-20 | 1/2   | 9/16  | 1.81 | 46.0 | 1.06 | 26.9 | 1         |
| 5C5-5RMFA            | 7236-04865 | 1/4   | 6.4  | 1/2-20  | 9/16  | 5/8   | 1.91 | 48.6 | 1.12 | 28.4 | 1         |
| 6C5-4RMFA            | 7236-04875 | 5/16  | 7.9  | 7/16-20 | 9/16  | 9/16  | 2.03 | 51.6 | 1.13 | 28.7 | 1         |
| 6C5-6RMFA            | 7236-04885 | 5/16  | 7.9  | 5/8-18  | 5/8   | 11/16 | 2.05 | 52.1 | 1.15 | 29.2 | 1         |
| 8C5-8RMFA            | 7236-04895 | 13/32 | 10.3 | 3/4-16  | 13/16 | 7/8   | 2.52 | 64.0 | 1.37 | 34.8 | 1         |
| 10C5-10RMFA          | 7236-04905 | 1/2   | 12.7 | 7/8-14  | 15/16 | 1     | 2.77 | 70.3 | 1.48 | 37.6 | 1         |

## Female Air Brake Swivel - Steel

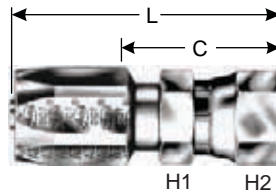

| Descr.               | Prod. No.  | ⊖     |      | 🌀      | H1  | H2  | L    |      | C    |      | Std. Pack |
|----------------------|------------|-------|------|--------|-----|-----|------|------|------|------|-----------|
|                      |            | "     | mm   |        | "   | "   | "    | mm   | "    | mm   |           |
| <b>STANDARD PACK</b> |            |       |      |        |     |     |      |      |      |      |           |
| 6C5-6RFABX           | 7238-04425 | 5/16  | 7.9  | 3/4-20 | 7/8 | 7/8 | 2.29 | 58.2 | 1.34 | 34.0 | 1         |
| 8C5-6RFABX           | 7238-04435 | 13/32 | 10.3 | 3/4-20 | 7/8 | 7/8 | 2.60 | 66.0 | 1.48 | 37.6 | 1         |

## Parker Triple Thread Female Swivel - Steel

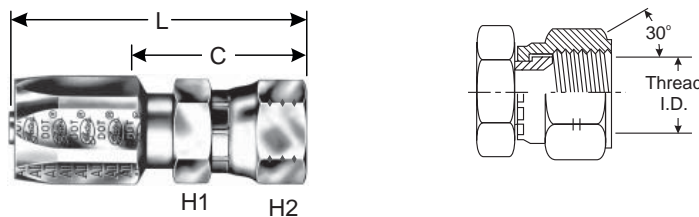

| Descr.               | Prod. No.  | ⊖   |      | 🌀         | H1    | H2    | L    |      | C    |      | Std. Pack |
|----------------------|------------|-----|------|-----------|-------|-------|------|------|------|------|-----------|
|                      |            | "   | mm   |           | "     | "     | "    | mm   | "    | mm   |           |
| <b>STANDARD PACK</b> |            |     |      |           |       |       |      |      |      |      |           |
| 16C5-16RFZX          | 7238-86461 | 7/8 | 22.2 | 1 5/16-14 | 1 1/2 | 1 1/2 | 2.90 | 73.7 | 1.72 | 43.7 | 1         |

# Field Attachable for C5C, C5D & C5M Hose



## Sockets for C5C, C5D & C5M Hose Only - Steel



| Descr.           | Prod. No. | ⊖     | Std. Pack |
|------------------|-----------|-------|-----------|
|                  |           | "     |           |
| <b>BULK PACK</b> |           |       |           |
| 4C5-FRLXBULK     | 7238-0498 | 3/16  | 25        |
| 5C5-FRLXBULK     | 7238-0499 | 1/4   | 25        |
| 6C5-FRLXBULK     | 7238-0500 | 5/16  | 25        |
| 8C5-FRLXBULK     | 7238-0501 | 13/32 | 25        |
| 10C5-FRLXBULK    | 7238-0502 | 1/2   | 10        |
| 12C5-FRLXBULK    | 7238-0503 | 5/8   | 10        |
| 16C5-FRLXBULK    | 7238-0504 | 7/8   | 10        |
| 20C5-FRLXBULK    | 7238-0505 | 1 1/8 | 5         |
| 24C5-FRLXBULK    | 7238-0506 | 1 3/8 | 5         |

## SAE Swivel Female Stem Only - Steel



| Descr.            | Prod. No. | ⊖    |  | Std. Pack |
|-------------------|-----------|------|---|-----------|
|                   |           | "    |   |           |
| <b>BULK PACK</b>  |           |      |   |           |
| 6C5-6RFSX-STXBULK | 7238-0441 | 5/16 | 5/8-18  | 25        |

|                                      |
|--------------------------------------|
| EQUIPMENT                            |
| HOSE/CPLG. SELECTION                 |
| GLOBALSPIRAL COUPLINGS               |
| PCM/PCS FERRULES                     |
| MEGACRIMP COUPLINGS                  |
| POWER CRIMP COUPLINGS                |
| LOW PRESSURE COUPLINGS               |
| POLARSEAL COUPLINGS                  |
| C14 COUPLINGS                        |
| PCTS THERMO-PLASTIC COUPLINGS        |
| FIELD ATTACHABLE G1 & G2 COUPLINGS   |
| <b>FIELD ATTACHABLE C5 COUPLINGS</b> |
| SURELOK AIR BRAKE COUPLINGS          |
| QUICK DISCONNECT COUPLERS            |
| NEW BALL VALVES                      |
| ACCESSORIES                          |
| EQUIPMENT AND PARTS                  |





# Field Attachable for C5E Hose

## Male Pipe (NPTF - 30° Cone Seat) - Steel

DOT FMVSS Type AI (No mandrel required).

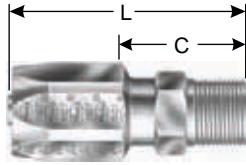

H1

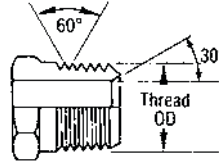

| Descr.               | Prod. No.  | ⊖     |      | 🌀        | H1     | H2 | L    |      | C    |      | Std. Pack |
|----------------------|------------|-------|------|----------|--------|----|------|------|------|------|-----------|
|                      |            | "     | mm   |          | "      | "  | "    | mm   | "    | mm   |           |
| <b>STANDARD PACK</b> |            |       |      |          |        |    |      |      |      |      |           |
| 4C5E-2RMP            | 7236-00755 | 3/16  | 4.8  | 1/8-27   | 1/2    | —  | 1.53 | 38.9 | .81  | 20.6 | 1         |
| 4C5E-4RMP            | 7236-00765 | 3/16  | 4.8  | 1/4-18   | 9/16   | —  | 1.75 | 44.5 | 1.03 | 26.2 | 1         |
| 5C5E-4RMP            | 7236-00775 | 1/4   | 6.4  | 1/4-18   | 9/16   | —  | 1.76 | 44.7 | .96  | 24.4 | 1         |
| 6C5E-4RMP            | 7236-00785 | 5/16  | 7.9  | 1/4-18   | 9/16   | —  | 1.85 | 47.0 | 1.00 | 25.4 | 1         |
| 6C5E-6RMP            | 7236-00795 | 5/16  | 7.9  | 3/8-18   | 11/16  | —  | 1.89 | 48.0 | 1.04 | 26.4 | 1         |
| 8C5E-6RMP            | 7236-00805 | 13/32 | 10.3 | 3/8-18   | 11/16  | —  | 2.19 | 55.6 | 1.19 | 30.2 | 1         |
| 8C5E-8RMP            | 7236-00815 | 13/32 | 10.3 | 1/2-14   | 7/8    | —  | 2.29 | 58.2 | 1.29 | 32.8 | 1         |
| 10C5E-8RMP           | 7236-00825 | 1/2   | 12.7 | 1/2-14   | 7/8    | —  | 2.38 | 60.5 | 1.31 | 33.3 | 1         |
| 12C5E-12RMP          | 7236-00835 | 5/8   | 15.9 | 3/4-14   | 1 1/16 | —  | 2.59 | 65.8 | 1.44 | 36.6 | 1         |
| 12C5E-16RMP          | 7236-00845 | 5/8   | 15.9 | 1-11 1/2 | 1 3/8  | —  | 2.87 | 72.9 | 1.72 | 43.7 | 1         |
| 16C5E-12RMP          | 7236-00865 | 7/8   | 22.2 | 3/4-14   | 1 1/16 | —  | 2.49 | 63.2 | 1.43 | 36.3 | 1         |
| 16C5E-16RMP          | 7236-00855 | 7/8   | 22.2 | 1-11 1/2 | 1 3/8  | —  | 2.80 | 71.1 | 1.74 | 44.2 | 1         |
| 20C5E-20RMP          | 7236-00885 | 1 1/8 | 28.6 | 1 1/4-11 | 1 3/4  | —  | 2.92 | 74.2 | 1.80 | 45.7 | 1         |
| <b>BULK PACK</b>     |            |       |      |          |        |    |      |      |      |      |           |
| 4C5E-2RMPXBULK       | 7236-0075  | 3/16  | 4.8  | 1/8-27   | 1/2    | —  | 1.53 | 38.9 | .81  | 20.6 | 300       |
| 4C5E-4RMPXBULK       | 7236-0076  | 3/16  | 4.8  | 1/4-18   | 9/16   | —  | 1.75 | 44.5 | 1.03 | 26.2 | 150       |
| 8C5E-6RMPXBULK       | 7236-0080  | 13/32 | 10.3 | 3/8-18   | 11/16  | —  | 2.19 | 55.6 | 1.19 | 30.2 | 100       |
| 20C5E-20RMPXBULK     | 7236-0088  | 1 1/8 | 28.6 | 1 1/4-11 | 1 3/4  | —  | 2.92 | 74.2 | 1.80 | 45.7 | 25        |

## Female JIC 37° Flare Swivel - Steel

DOT FMVSS Type AI (No mandrel required).

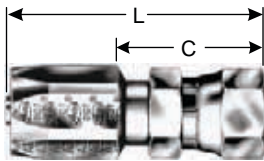

H1 H2

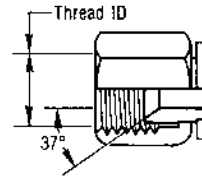

| Descr.               | Prod. No.  | ⊖     |      | 🌀         | H1     | H2    | L    |      | C    |      | Std. Pack |
|----------------------|------------|-------|------|-----------|--------|-------|------|------|------|------|-----------|
|                      |            | "     | mm   |           | "      | "     | "    | mm   | "    | mm   |           |
| <b>STANDARD PACK</b> |            |       |      |           |        |       |      |      |      |      |           |
| 6C5E-6RFJX           | 7238-01025 | 5/16  | 7.9  | 9/16-18   | 3/4    | 3/4   | 2.04 | 51.8 | 1.19 | 30.2 | 1         |
| 12C5E-12RFJX         | 7238-01055 | 5/8   | 15.9 | 1 1/16-12 | 1 1/4  | 1 1/4 | 2.92 | 74.2 | 1.78 | 45.2 | 1         |
| 16C5E-16RFJX         | 7238-01065 | 7/8   | 22.2 | 1 5/16-12 | 1 1/2  | 1 1/2 | 2.90 | 73.7 | 1.84 | 46.7 | 1         |
| 20C5E-20RFJX         | 7238-01215 | 1 1/8 | 28.6 | 1 5/8-12  | 1 9/16 | 2     | 3.34 | 84.8 | 2.20 | 55.9 | 1         |
| <b>BULK PACK</b>     |            |       |      |           |        |       |      |      |      |      |           |
| 6C5E-6RFJX XBULK     | 7238-0102  | 5/16  | 7.9  | 9/16-18   | 3/4    | 3/4   | 2.04 | 51.8 | 1.19 | 30.2 | 250       |
| 12C5E-12RFJX XBULK   | 7238-0105  | 5/8   | 15.9 | 1 1/16-12 | 1 1/4  | 1 1/4 | 2.92 | 74.2 | 1.78 | 45.2 | 75        |
| 16C5E-16RFJX XBULK   | 7238-0106  | 7/8   | 22.2 | 1 5/16-12 | 1 1/2  | 1 1/2 | 2.90 | 73.7 | 1.84 | 46.7 | 50        |



# Field Attachable for C5E Hose



## Female JIC 37° Flare Swivel - 45° Bent Tube - Steel

DOT FMVSS Type AI (No mandrel required).

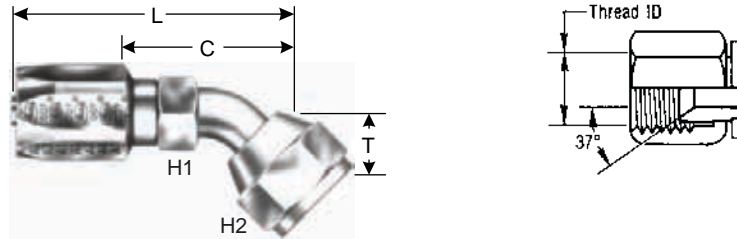

| Descr.               | Prod. No.  | ⊖    |      | 🌀         | H1  | H2    | T   |      | L    |      | C    |      | Std. Pack |
|----------------------|------------|------|------|-----------|-----|-------|-----|------|------|------|------|------|-----------|
|                      |            | "    | mm   |           | "   | "     | "   | mm   | "    | mm   | "    | mm   |           |
| <b>STANDARD PACK</b> |            |      |      |           |     |       |     |      |      |      |      |      |           |
| 6C5E-6RFJX45         | 7235-20415 | 5/16 | 7.9  | 9/16-18   | 1/2 | 11/16 | .41 | 10.4 | 2.33 | 59.2 | 1.48 | 37.6 | 1         |
| 12C5E-12RFJX45       | 7235-20455 | 5/8  | 15.9 | 1 1/16-12 | 7/8 | 1 1/4 | .78 | 19.8 | 3.63 | 92.2 | 2.49 | 63.2 | 1         |

## Female JIC 37° Flare Swivel - 90° Bent Tube - Steel

DOT FMVSS Type AI (No mandrel required).

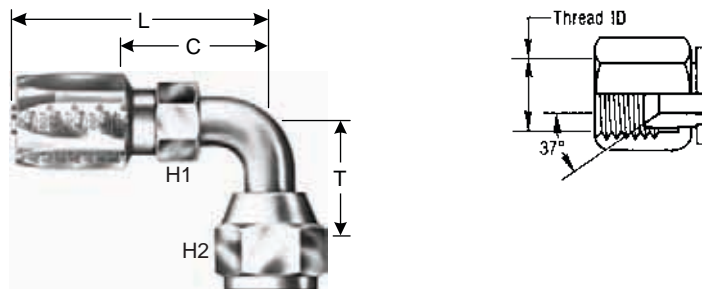

| Descr.               | Prod. No.  | ⊖     |      | 🌀         | H1    | H2     | T    |      | L    |       | C    |       | Std. Pack |
|----------------------|------------|-------|------|-----------|-------|--------|------|------|------|-------|------|-------|-----------|
|                      |            | "     | mm   |           | "     | "      | "    | mm   | "    | mm    | "    | mm    |           |
| <b>STANDARD PACK</b> |            |       |      |           |       |        |      |      |      |       |      |       |           |
| 6C5E-6RFJX90         | 7235-00305 | 5/16  | 7.9  | 9/16-18   | 1/2   | 11/16  | .84  | 21.3 | 2.21 | 56.1  | 1.36 | 34.5  | 1         |
| 12C5E-12RFJX90       | 7235-00265 | 5/8   | 15.9 | 1 1/16-12 | 7/8   | 1 1/4  | 1.81 | 46.0 | 3.58 | 90.9  | 2.44 | 62.0  | 1         |
| 16C5E-16RFJX90       | 7235-00285 | 7/8   | 22.2 | 1 5/16-13 | 1 1/4 | 1 1/2  | 2.16 | 54.9 | 3.72 | 94.5  | 2.66 | 67.6  | 1         |
| 20C5E-20RFJX90       | 7235-20345 | 1 1/8 | 26.6 | 1 5/8-12  | 2     | 1 9/16 | 2.65 | 67.3 | 5.58 | 141.0 | 4.45 | 113.0 | 1         |
| <b>BULK PACK</b>     |            |       |      |           |       |        |      |      |      |       |      |       |           |
| 6C5E-6RFJX90XBULK    | 7235-0030  | 5/16  | 7.9  | 9/16-18   | 1/2   | 11/16  | .84  | 21.3 | 2.21 | 56.1  | 1.36 | 34.5  | 75        |
| 20C5E-20RFJX90XBULK  | 7235-2034  | 1 1/8 | 26.6 | 1 5/8-12  | 2     | 1 9/16 | 2.65 | 67.3 | 5.58 | 141.0 | 4.45 | 113.0 | 20        |

|                                    |
|------------------------------------|
| EQUIPMENT                          |
| HOSE/CPLG. SELECTION               |
| GLOBALSPIRAL COUPLINGS             |
| PCM/PCS FERRULES                   |
| MEGACRIMP COUPLINGS                |
| POWER CRIMP COUPLINGS              |
| LOW PRESSURE COUPLINGS             |
| POLARSEAL COUPLINGS                |
| C14 COUPLINGS                      |
| PCTS THERMO-PLASTIC COUPLINGS      |
| FIELD ATTACHABLE G1 & G2 COUPLINGS |
| FIELD ATTACHABLE C5 COUPLINGS      |
| SURELOK AIR BRAKE COUPLINGS        |
| QUICK DISCONNECT COUPLERS          |
| NEW BALL VALVES                    |
| ACCESSORIES                        |
| EQUIPMENT AND PARTS                |





# Field Attachable for C5E Hose

## Female SAE 45° Flare Swivel - Steel

DOT FMVSS Type AI (No mandrel required).

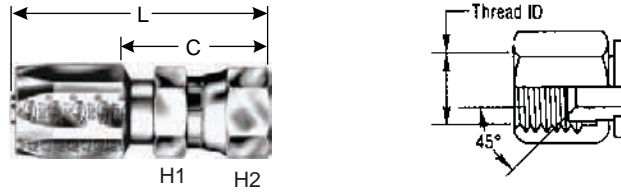

| Descr.               | Prod. No.  | ⊖    |      | 🌀         | H1    |       | L    |      | C    |      | Std. Pack |
|----------------------|------------|------|------|-----------|-------|-------|------|------|------|------|-----------|
|                      |            | "    | mm   |           | "     | "     | "    | mm   | "    | mm   |           |
| <b>STANDARD PACK</b> |            |      |      |           |       |       |      |      |      |      |           |
| 6C5E-6RFSX           | 7238-00955 | 5/16 | 7.9  | 5/8-18    | 3/4   | 3/4   | 2.13 | 54.1 | 1.28 | 32.5 | 5         |
| 12C5E-12RFSX         | 7238-00985 | 5/8  | 15.9 | 1 1/16-14 | 1 1/4 | 1 1/4 | 2.94 | 74.7 | 1.80 | 45.7 | 1         |
| <b>BULK PACK</b>     |            |      |      |           |       |       |      |      |      |      |           |
| 12C5E-12RFSX XBULK   | 7238-0098  | 5/8  | 15.9 | 1 1/16-14 | 1 1/4 | 1 1/4 | 2.94 | 74.7 | 1.80 | 45.7 | 50        |

## Female SAE 45° Flare Swivel - 45° Bent Tube - Steel

DOT FMVSS Type AI (No mandrel required).

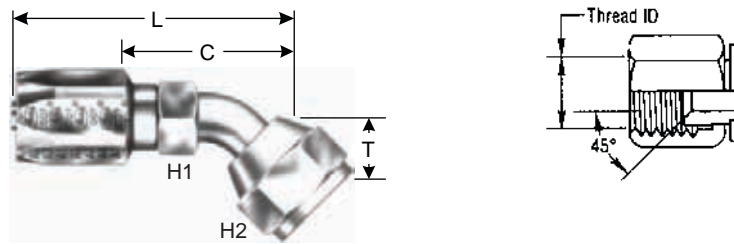

| Descr.               | Prod. No.  | ⊖    |      | 🌀         | H1  | H2    | T   |      | L    |      | C    |      | Std. Pack |
|----------------------|------------|------|------|-----------|-----|-------|-----|------|------|------|------|------|-----------|
|                      |            | "    | mm   |           |     |       | "   | mm   | "    | mm   | "    | mm   |           |
| <b>STANDARD PACK</b> |            |      |      |           |     |       |     |      |      |      |      |      |           |
| 6C5E-6RFSX45         | 7235-20425 | 5/16 | 7.9  | 5/8-18    | 1/2 | 3/4   | .41 | 10.4 | 2.33 | 59.2 | 1.48 | 37.6 | 1         |
| 12C5E-12RFSX45       | 7235-20465 | 5/8  | 15.9 | 1 1/16-14 | 7/8 | 1 1/4 | .78 | 19.8 | 3.63 | 92.2 | 2.49 | 63.2 | 1         |

- EQUIPMENT
- HOSE/CPLG. SELECTION
- GLOBALSPIRAL COUPLINGS
- PCM/PCS FERRULES
- MEGACRIMP COUPLINGS
- POWER CRIMP COUPLINGS
- LOW PRESSURE COUPLINGS
- POLARSEAL COUPLINGS
- C14 COUPLINGS
- PCTS THERMO-PLASTIC COUPLINGS
- FIELD ATTACHABLE G1 & G2 COUPLINGS
- FIELD ATTACHABLE C5 COUPLINGS
- SURELOK AIR BRAKE COUPLINGS
- QUICK DISCONNECT COUPLERS
- NEW BALL VALVES
- ACCESSORIES
- EQUIPMENT AND PARTS



# Field Attachable for C5E Hose



## Female SAE 45° Flare Swivel - 90° Bent Tube - Steel

DOT FMVSS Type AI (No mandrel required).

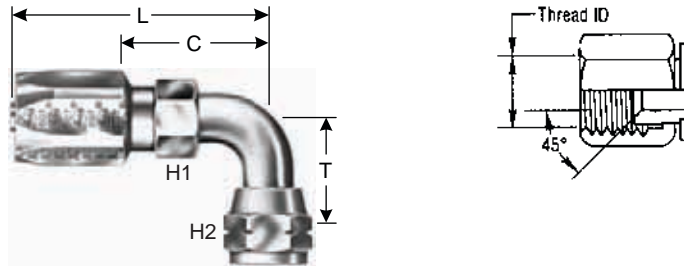

| Descr.               | Prod. No.  | ⊖    |      | 🌀         | H1  | H2    | T    |      | L    |      | C    |      | Std. Pack |
|----------------------|------------|------|------|-----------|-----|-------|------|------|------|------|------|------|-----------|
|                      |            | "    | mm   |           |     |       | "    | mm   | "    | mm   | "    | mm   |           |
| <b>STANDARD PACK</b> |            |      |      |           |     |       |      |      |      |      |      |      |           |
| 6C5E-6RFSX90         | 7235-00315 | 5/16 | 7.9  | 5/8-18    | 1/2 | 3/4   | .84  | 21.3 | 2.21 | 56.1 | 1.36 | 34.5 | 1         |
| 12C5E-12RFSX90       | 7235-00275 | 5/8  | 15.9 | 1 1/16-14 | 7/8 | 1 1/4 | 1.81 | 46.0 | 3.58 | 90.9 | 2.44 | 62.0 | 1         |
| <b>BULK PACK</b>     |            |      |      |           |     |       |      |      |      |      |      |      |           |
| 12C5E-12RFSX90XBULK  | 7235-0027  | 5/8  | 15.9 | 1 1/16-14 | 7/8 | 1 1/4 | 1.81 | 46.0 | 3.58 | 90.9 | 2.44 | 62.0 | 35        |

## Dual Seat Female JIC 37°/SAE 45° Flare Swivel - Steel

DOT FMVSS Type AI (No mandrel required).

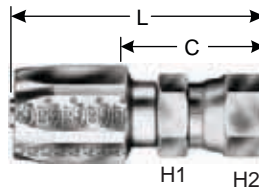

| Descr.               | Prod. No.  | ⊖     |      | 🌀       | H1     | H2     | L    |      | C    |      | Std. Pack |
|----------------------|------------|-------|------|---------|--------|--------|------|------|------|------|-----------|
|                      |            | "     | mm   |         |        |        | "    | mm   | "    | mm   |           |
| <b>STANDARD PACK</b> |            |       |      |         |        |        |      |      |      |      |           |
| 4C5E-4RFJSX          | 7238-01005 | 3/16  | 4.8  | 7/16-20 | 1/2    | 9/16   | 1.82 | 46.2 | 1.10 | 27.9 | 5         |
| 5C5E-5RFJSX          | 7238-01015 | 1/4   | 6.3  | 1/2-20  | 1/2    | 11/16  | 2.00 | 50.8 | 1.21 | 30.7 | 1         |
| 8C5E-8RFJSX          | 7238-01035 | 13/32 | 10.3 | 3/4-16  | 7/8    | 7/8    | 2.45 | 62.2 | 1.45 | 36.8 | 5         |
| 10C5E-10RFJSX        | 7238-01045 | 1/2   | 12.7 | 7/8-14  | 1 1/16 | 1 1/16 | 2.72 | 69.1 | 1.65 | 41.9 | 5         |
| <b>BULK PACK</b>     |            |       |      |         |        |        |      |      |      |      |           |
| 4C5E-4RFJSX XBULK    | 7238-0100  | 3/16  | 4.8  | 7/16-20 | 1/2    | 9/16   | 1.82 | 46.2 | 1.10 | 27.9 | 300       |
| 5C5E-5RFJSX XBULK    | 7238-0101  | 1/4   | 6.3  | 1/2-20  | 1/2    | 11/16  | 2.00 | 50.8 | 1.21 | 30.7 | 300       |
| 8C5E-8RFJSX XBULK    | 7238-0103  | 13/32 | 10.3 | 3/4-16  | 7/8    | 7/8    | 2.45 | 62.2 | 1.45 | 36.8 | 200       |
| 10C5E-10RFJSX XBULK  | 7238-0104  | 1/2   | 12.7 | 7/8-14  | 1 1/16 | 1 1/16 | 2.72 | 69.1 | 1.65 | 41.9 | 75        |

|                                    |
|------------------------------------|
| EQUIPMENT                          |
| HOSE/CPLG. SELECTION               |
| GLOBALSPIRAL COUPLINGS             |
| PCM/PCS FERRULES                   |
| MEGACRIMP COUPLINGS                |
| POWER CRIMP COUPLINGS              |
| LOW PRESSURE COUPLINGS             |
| POLARSEAL COUPLINGS                |
| C14 COUPLINGS                      |
| PCTS THERMO-PLASTIC COUPLINGS      |
| FIELD ATTACHABLE G1 & G2 COUPLINGS |
| FIELD ATTACHABLE C5 COUPLINGS      |
| SURELOK AIR BRAKE COUPLINGS        |
| QUICK DISCONNECT COUPLERS          |
| NEW BALL VALVES                    |
| ACCESSORIES                        |
| EQUIPMENT AND PARTS                |



# Field Attachable for C5E Hose

## Dual Seat Female JIC 37°/SAE 45° Flare Swivel - 45° Bent Tube - Steel

DOT FMVSS Type AI (No mandrel required).

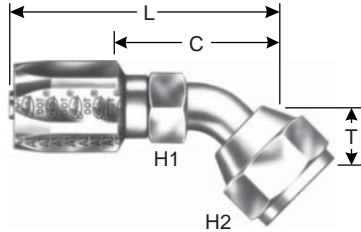

| Descr.               | Prod. No.  | ⊖     |      | 🌀       | H1    | H2   | T   |      | L    |      | C    |      | Std. Pack |
|----------------------|------------|-------|------|---------|-------|------|-----|------|------|------|------|------|-----------|
|                      |            | "     | mm   |         | "     | "    | "   | mm   | "    | mm   | "    | mm   |           |
| <b>STANDARD PACK</b> |            |       |      |         |       |      |     |      |      |      |      |      |           |
| 4C5E-4RFJSX45        | 7235-20405 | 3/16  | 4.8  | 7/16-20 | 1/2   | 9/16 | .34 | 8.6  | 1.92 | 48.8 | 1.20 | 30.5 | 1         |
| 8C5E-8RFJSX45        | 7235-20435 | 13/32 | 10.3 | 3/4-16  | 11/16 | 7/8  | .56 | 14.2 | 2.73 | 69.3 | 1.73 | 43.9 | 1         |
| 10C5E-10RFJSX45      | 7235-20445 | 1/2   | 12.7 | 7/8-14  | 3/4   | 1    | .63 | 16.0 | 3.17 | 80.5 | 2.11 | 53.6 | 1         |
| <b>BULK PACK</b>     |            |       |      |         |       |      |     |      |      |      |      |      |           |
| 10C5E-10RFJSX45XBULK | 7235-2044  | 1/2   | 12.7 | 7/8-14  | 3/4   | 1    | .63 | 16.0 | 3.17 | 80.5 | 2.11 | 53.6 | 60        |

## Dual Seat Female JIC 37°/SAE 45° Flare Swivel - 90° Bent Tube - Steel

DOT FMVSS Type AI (No mandrel required).

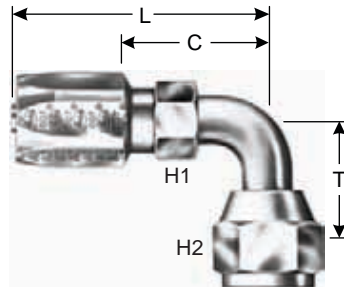

| Descr.               | Prod. No.  | ⊖     |      | 🌀       | H1    | H2   | T    |      | L    |      | C    |      | Std. Pack |
|----------------------|------------|-------|------|---------|-------|------|------|------|------|------|------|------|-----------|
|                      |            | "     | mm   |         | "     | "    | "    | mm   | "    | mm   | "    | mm   |           |
| <b>STANDARD PACK</b> |            |       |      |         |       |      |      |      |      |      |      |      |           |
| 4C5E-4RFJSX90        | 7235-20305 | 3/16  | 4.8  | 7/16-20 | 1/2   | 9/16 | .69  | 17.5 | 1.72 | 43.7 | 1.00 | 25.4 | 1         |
| 8C5E-8RFJSX90        | 7235-20315 | 13/32 | 10.3 | 3/4-16  | 11/16 | 7/8  | 1.09 | 27.7 | 2.54 | 64.5 | 1.54 | 39.1 | 1         |
| 10C5E-10RFJSX90      | 7235-20325 | 1/2   | 12.7 | 7/8-14  | 3/4   | 1    | 1.25 | 31.8 | 2.97 | 75.4 | 1.91 | 48.5 | 1         |
| <b>BULK PACK</b>     |            |       |      |         |       |      |      |      |      |      |      |      |           |
| 4C5E-4RFJSX90XBULK   | 7235-2030  | 3/16  | 4.8  | 7/16-20 | 1/2   | 9/16 | .69  | 17.5 | 1.72 | 43.7 | 1.00 | 25.4 | 200       |

# Field Attachable for C5E Hose



## Male SAE 45° Flare Inverted Swivel - Steel

DOT FMVSS Type AI (No mandrel required).

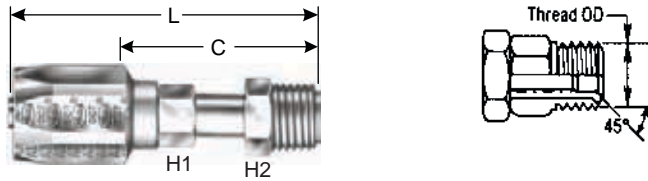

| Descr.               | Prod. No.  | ⊖     |      | 🌀       | H1    | H2   | L    |      | C    |      | Std. Pack |
|----------------------|------------|-------|------|---------|-------|------|------|------|------|------|-----------|
|                      |            | "     | mm   |         |       |      | "    | mm   | "    | mm   |           |
| <b>STANDARD PACK</b> |            |       |      |         |       |      |      |      |      |      |           |
| 4C5E-4RMIX           | 7235-02855 | 3/16  | 4.8  | 7/16-24 | 1/2   | 7/16 | 2.05 | 52.1 | 1.33 | 33.8 | 1         |
| 5C5E-5RMIX           | 7235-02865 | 1/4   | 6.3  | 1/2-20  | 1/2   | 1/2  | 2.26 | 57.4 | 1.45 | 36.8 | 1         |
| 6C5E-5RMIX           | 7235-02875 | 5/16  | 7.9  | 1/2-20  | 1/2   | 1/2  | 2.39 | 60.7 | 1.54 | 39.1 | 1         |
| 6C5E-6RMIX           | 7235-02885 | 5/16  | 7.9  | 5/8-18  | 1/2   | 5/8  | 2.71 | 68.8 | 1.86 | 47.2 | 1         |
| 8C5E-8RMIX           | 7235-02895 | 13/32 | 10.3 | 3/4-16  | 11/16 | 3/4  | 3.24 | 82.3 | 2.24 | 56.9 | 1         |

## Male SAE 45° Flare Inverted Swivel - 45° Bent Tube - Steel

DOT FMVSS Type AI (No mandrel required).

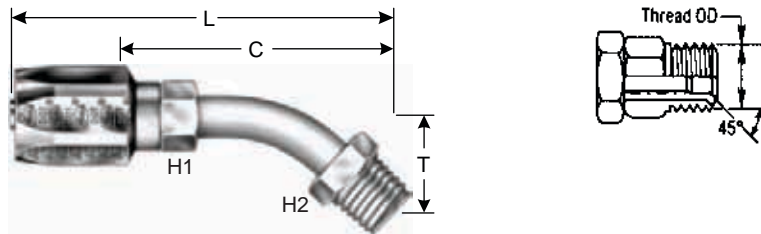

| Descr.               | Prod. No.  | ⊖     |      | 🌀      | H1    | H2  | T    | L    |      | C     |      | Std. Pack |   |
|----------------------|------------|-------|------|--------|-------|-----|------|------|------|-------|------|-----------|---|
|                      |            | "     | mm   |        |       |     |      | "    | mm   | "     | mm   |           |   |
| <b>STANDARD PACK</b> |            |       |      |        |       |     |      |      |      |       |      |           |   |
| 6C5E-6RMIX45         | 7235-02795 | 5/16  | 7.9  | 5/8-18 | 1/2   | 5/8 | .84  | 21.3 | 3.79 | 96.3  | 2.94 | 74.7      | 1 |
| 8C5E-8RMIX45         | 7235-02905 | 13/32 | 10.3 | 3/4-18 | 11/16 | 3/4 | 1.09 | 27.7 | 4.24 | 107.7 | 3.24 | 82.3      | 1 |

EQUIPMENT

HOSE/CPLG. SELECTION

GLOBALSPIRAL COUPLINGS

PCM/PCS FERRULES

MEGACRIMP COUPLINGS

POWER CRIMP COUPLINGS

LOW PRESSURE COUPLINGS

POLARSEAL COUPLINGS

C14 COUPLINGS

PCTS THERMO-PLASTIC COUPLINGS

FIELD ATTACHABLE G1 & G2 COUPLINGS

FIELD ATTACHABLE C5 COUPLINGS

SURELOK AIR BRAKE COUPLINGS

QUICK DISCONNECT COUPLERS

NEW BALL VALVES

ACCESSORIES

EQUIPMENT AND PARTS



The World's Most Trusted Name in Belts, Hose and Hydraulics.

[www.gates.com/hydraulics](http://www.gates.com/hydraulics)

M19



# Field Attachable for C5E Hose

## Male SAE 45° Flare Inverted Swivel - 90° Bent Tube - Steel

DOT FMVSS Type AI (No mandrel required).

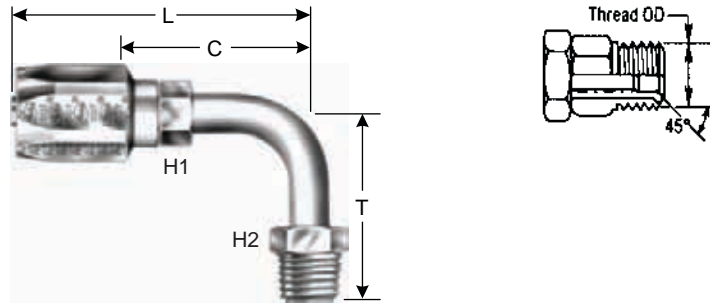

| Descr.               | Prod. No.  | ⊖     |      | 🌀       | H1    | H2   | T    |      | L    |      | C    |      | Std. Pack |
|----------------------|------------|-------|------|---------|-------|------|------|------|------|------|------|------|-----------|
|                      |            | "     | mm   |         | "     | "    | "    | mm   | "    | mm   | "    | mm   |           |
| <b>STANDARD PACK</b> |            |       |      |         |       |      |      |      |      |      |      |      |           |
| 4C5E-4RMIX90         | 7235-02805 | 3/16  | 4.8  | 7/16-24 | 1/2   | 7/16 | 1.25 | 31.8 | 2.05 | 52.1 | 1.33 | 33.8 | 1         |
| 5C5E-5RMIX90         | 7235-02815 | 1/4   | 6.3  | 1/2-20  | 1/2   | 1/2  | 1.50 | 38.1 | 2.25 | 57.1 | 1.46 | 37.1 | 1         |
| 6C5E-5RMIX90         | 7235-02825 | 5/16  | 7.9  | 1/2-20  | 1/2   | 1/2  | 1.50 | 38.1 | 2.39 | 60.7 | 1.54 | 39.1 | 1         |
| 6C5E-6RMIX90         | 7235-02835 | 5/16  | 7.9  | 5/8-18  | 1/2   | 5/8  | 1.63 | 41.4 | 2.71 | 68.8 | 1.86 | 47.2 | 1         |
| 8C5E-8RMIX90         | 7235-02845 | 13/32 | 10.3 | 3/4-16  | 11/16 | 3/4  | 2.00 | 50.8 | 3.24 | 82.3 | 2.24 | 56.9 | 1         |

## SAE Male Flareless Assembly - Steel

DOT FMVSS Type AI (No mandrel required).



| Descr.               | Prod. No.  | ⊖     |      | 🌀       | H1    | H2    | L    |      | C    |      | Std. Pack |
|----------------------|------------|-------|------|---------|-------|-------|------|------|------|------|-----------|
|                      |            | "     | mm   |         | "     | "     | "    | mm   | "    | mm   |           |
| <b>STANDARD PACK</b> |            |       |      |         |       |       |      |      |      |      |           |
| 4C5E-4RMFA           | 7236-04955 | 3/16  | 4.8  | 7/16-20 | 1/2   | 9/16  | 1.68 | 42.7 | .96  | 24.5 | 1         |
| 5C5E-5RMFA           | 7236-04965 | 1/4   | 6.3  | 1/2-20  | 9/16  | 5/8   | 1.72 | 43.7 | .92  | 23.4 | 1         |
| 6C5E-4RMFA           | 7236-04975 | 5/16  | 7.9  | 7/16-20 | 9/16  | 9/16  | 2.12 | 53.8 | 1.01 | 25.6 | 1         |
| 6C5E-6RMFA           | 7236-04985 | 5/16  | 7.9  | 9/16-18 | 5/8   | 11/16 | 1.87 | 47.6 | 1.03 | 26.2 | 1         |
| 8C5E-8RMFA           | 7236-04995 | 13/32 | 10.3 | 3/4-16  | 13/16 | 7/8   | 2.15 | 54.6 | 1.15 | 29.2 | 1         |
| 10C5E-10RMFA         | 7236-05005 | 1/2   | 12.7 | 7/8-14  | 15/16 | 1     | 2.34 | 59.6 | 1.27 | 32.2 | 1         |

- EQUIPMENT
- HOSE/CPLG. SELECTION
- GLOBALSPIRAL COUPLINGS
- PCM/PCS FERRULES
- MEGACRIMP COUPLINGS
- POWER CRIMP COUPLINGS
- LOW PRESSURE COUPLINGS
- POLARSEAL COUPLINGS
- C14 COUPLINGS
- PCTS THERMO-PLASTIC COUPLINGS
- FIELD ATTACHABLE G1 & G2 COUPLINGS
- FIELD ATTACHABLE C5 COUPLINGS
- SURELOK AIR BRAKE COUPLINGS
- QUICK DISCONNECT COUPLERS
- NEW BALL VALVES
- ACCESSORIES
- EQUIPMENT AND PARTS





# Field Attachable for C5E Hose

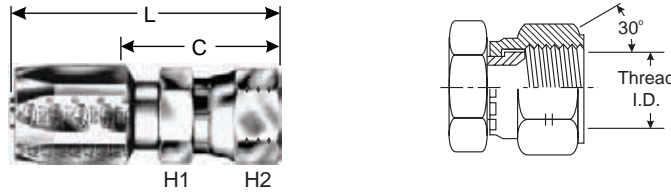

## Parker Triple Thread Female Swivel - Steel

DOT FMVSS Type AI (No mandrel required).



| Descr.               | Prod. No.  | ⊖   |      |  | H1    | H2    | L    |      | C    |      | Std. Pack |
|----------------------|------------|-----|------|---|-------|-------|------|------|------|------|-----------|
|                      |            | "   | mm   |   | "     | "     | "    | mm   | "    | mm   |           |
| <b>STANDARD PACK</b> |            |     |      |   |       |       |      |      |      |      |           |
| 16C5E-16RFZX         | 7238-01075 | 7/8 | 22.2 | 1 5/16-14   | 1 1/2 | 1 1/2 | 2.74 | 69.6 | 1.68 | 42.7 | 1         |

## Special Flange - 90° - Engine Oil Connection (Code 61-2 bolt) - Steel

DOT FMVSS Type AI (No mandrel required).

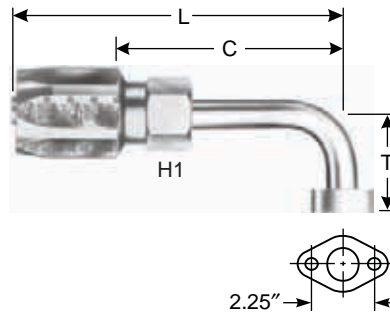

| Descr.               | Prod. No.  | ⊖     |      | H1     | H2 | T    | L    |      | C     |      | Std. Pack |    |
|----------------------|------------|-------|------|--------|----|------|------|------|-------|------|-----------|----|
|                      |            | "     | mm   | "      | "  | "    | mm   | "    | mm    | "    |           | mm |
| <b>STANDARD PACK</b> |            |       |      |        |    |      |      |      |       |      |           |    |
| 20C5E-20RFL90S       | 7235-20355 | 1 1/8 | 28.6 | 1 9/16 | —  | 2.50 | 63.5 | 4.95 | 125.7 | 3.82 | 97.0      | 1  |

EQUIPMENT

HOSE/CPLG. SELECTION

GLOBALSPIRAL COUPLINGS

PCM/PCS FERRULES

MEGACRIMP COUPLINGS

POWER CRIMP COUPLINGS

LOW PRESSURE COUPLINGS

POLARSEAL COUPLINGS

C14 COUPLINGS

PCTS THERMO-PLASTIC COUPLINGS

FIELD ATTACHABLE G1 & G2 COUPLINGS

FIELD ATTACHABLE C5 COUPLINGS

SURELOK AIR BRAKE COUPLINGS

QUICK DISCONNECT COUPLERS

NEW BALL VALVES

ACCESSORIES

EQUIPMENT AND PARTS



The World's Most Trusted Name in Belts, Hose and Hydraulics.

[www.gates.com/hydraulics](http://www.gates.com/hydraulics)

M21