

Field Attachable 'Type T' for G1 Hose (1-Wire)

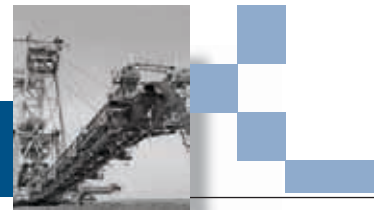

Male Pipe (NPTF - 30° Cone Seat)

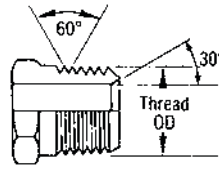
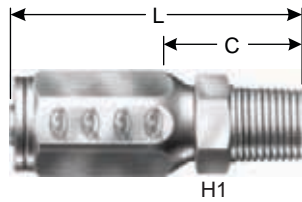

| Descr. | Prod. No. | ⊖ | | 🌀 | H1 | H2 | L | | C | | Std. Pack |
|----------------------|------------|-----|------|----------|--------|----|------|------|------|------|-----------|
| | | " | mm | | | | " | mm | " | mm | |
| STANDARD PACK | | | | | | | | | | | |
| 4C1T-2RMP | 7231-81241 | 1/4 | 6.4 | 1/8-27 | 1/2 | — | 2.30 | 58.4 | 1.29 | 32.8 | 1 |
| 4C1T-4RMP | 7231-81210 | 1/4 | 6.4 | 1/4-18 | 9/16 | — | 2.52 | 64.0 | 1.51 | 38.4 | 1 |
| 6C1T-4RMP | 7231-81242 | 3/8 | 9.5 | 1/4-18 | 9/16 | — | 2.68 | 68.1 | 1.54 | 39.1 | 1 |
| 6C1T-6RMP | 7231-81211 | 3/8 | 9.5 | 3/8-18 | 11/16 | — | 2.53 | 64.3 | 1.39 | 35.3 | 1 |
| 8C1T-6RMP | 7231-81243 | 1/2 | 12.7 | 3/8-18 | 11/16 | — | 3.05 | 77.5 | 1.70 | 43.2 | 1 |
| 8C1T-8RMP | 7231-81212 | 1/2 | 12.7 | 1/2-14 | 7/8 | — | 3.06 | 77.7 | 1.71 | 43.4 | 1 |
| 8C1T-12RMP | 7231-81244 | 1/2 | 12.7 | 3/4-14 | 1 1/16 | — | 3.13 | 79.5 | 1.87 | 47.5 | 1 |
| 12C1T-12RMP | 7231-81213 | 3/4 | 19.0 | 3/4-14 | 1 1/16 | — | 3.19 | 81.0 | 1.73 | 43.9 | 1 |
| 16C1T-16RMP | 7231-81214 | 1 | 25.4 | 1-11 1/2 | 1 3/8 | — | 3.78 | 96.0 | 2.10 | 53.3 | 1 |

Male Pipe Swivel (NPTF - Without 30° Cone Seat)

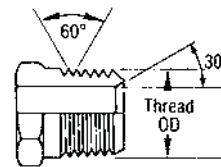
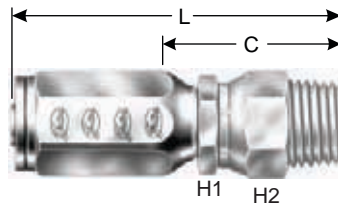

| Descr. | Prod. No. | ⊖ | | 🌀 | H1 | H2 | L | | C | | Std. Pack |
|----------------------|------------|-----|------|--------|--------|--------|------|-------|------|------|-----------|
| | | " | mm | | | | " | mm | " | mm | |
| STANDARD PACK | | | | | | | | | | | |
| 4C1T-4RMPX | 7231-22445 | 1/4 | 6.4 | 1/4-18 | 7/16 | 7/8 | 3.18 | 80.8 | 2.17 | 55.1 | 1 |
| 6C1T-6RMPX | 7231-22455 | 3/8 | 9.5 | 3/8-18 | 5/8 | 7/8 | 3.51 | 89.2 | 2.23 | 56.6 | 1 |
| 8C1T-8RMPX | 7231-22465 | 1/2 | 12.7 | 1/2-14 | 3/4 | 1 | 3.99 | 101.3 | 2.63 | 66.8 | 1 |
| 12C1T-12RMPX | 7231-22475 | 3/4 | 19.0 | 3/4-14 | 1 1/16 | 1 5/16 | 4.27 | 108.5 | 2.73 | 69.3 | 1 |

EQUIPMENT

HOSE/CPLG. SELECTION

GLOBALSPIRAL COUPLINGS

PCM/PCS FERRULES

MEGACRIMP COUPLINGS

POWER CRIMP COUPLINGS

LOW PRESSURE COUPLINGS

POLARSEAL COUPLINGS

C14 COUPLINGS

PCTS THERMO-PLASTIC COUPLINGS

FIELD ATTACHABLE G1 & G2 COUPLINGS

FIELD ATTACHABLE C5 COUPLINGS

SURELOK AIR BRAKE COUPLINGS

QUICK DISCONNECT COUPLERS

NEW BALL VALVES

ACCESSORIES

EQUIPMENT AND PARTS



The World's Most Trusted Name in Belts, Hose and Hydraulics.

www.gates.com/hydraulics

L1



Field Attachable 'Type T' for G1 Hose (1-Wire)

| |
|------------------------------------|
| EQUIPMENT |
| HOSE/CPLG. SELECTION |
| GLOBALSPIRAL COUPLINGS |
| PCM/PCS FERRULES |
| MEGACRIMP COUPLINGS |
| POWER CRIMP COUPLINGS |
| LOW PRESSURE COUPLINGS |
| POLARSEAL COUPLINGS |
| C14 COUPLINGS |
| PCTS THERMO-PLASTIC COUPLINGS |
| FIELD ATTACHABLE G1 & G2 COUPLINGS |
| FIELD ATTACHABLE C5 COUPLINGS |
| SURELOK AIR BRAKE COUPLINGS |
| QUICK DISCONNECT COUPLERS |
| NEW BALL VALVES |
| ACCESSORIES |
| EQUIPMENT AND PARTS |

Male O-Ring Boss

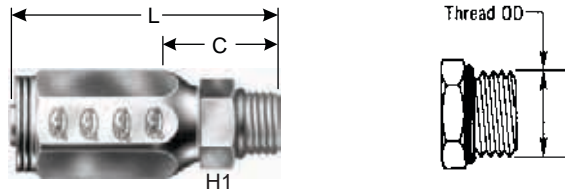

| Descr. | Prod. No. | ⊖ | | 🌀 | H1 | H2 | L | | C | | Std. Pack |
|----------------------|------------|-----|------|---------|-------|----|------|------|------|------|-----------|
| | | " | mm | | " | " | " | mm | " | mm | |
| STANDARD PACK | | | | | | | | | | | |
| 6C1T-6RMB | 7231-22255 | 3/8 | 9.5 | 9/16-18 | 11/16 | — | 2.52 | 64.0 | 1.24 | 31.5 | 1 |
| 6C1T-8RMB | 7231-22265 | 3/8 | 9.5 | 3/4-16 | 7/8 | — | 2.59 | 65.8 | 1.32 | 33.5 | 1 |
| 8C1T-8RMB | 7231-22275 | 1/2 | 12.7 | 3/4-16 | 7/8 | — | 2.87 | 72.9 | 1.52 | 38.6 | 1 |
| 8C1T-10RMB | 7231-22285 | 1/2 | 12.7 | 7/8-14 | 1 | — | 3.11 | 79.0 | 1.76 | 44.7 | 1 |

Male JIC 37° Flare

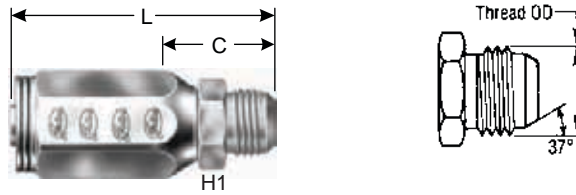

| Descr. | Prod. No. | ⊖ | | 🌀 | H1 | H2 | L | | C | | Std. Pack |
|----------------------|------------|-----|------|-----------|--------|----|------|------|------|------|-----------|
| | | " | mm | | " | " | " | mm | " | mm | |
| STANDARD PACK | | | | | | | | | | | |
| 6C1T-6RMJ | 7231-22185 | 3/8 | 9.5 | 9/16-18 | 9/16 | — | 2.68 | 68.1 | 1.40 | 35.6 | 1 |
| 8C1T-8RMJ | 7231-22195 | 1/2 | 12.7 | 3/4-16 | 3/4 | — | 3.05 | 77.5 | 1.70 | 43.2 | 1 |
| 8C1T-10RMJ | 7231-22205 | 1/2 | 12.7 | 7/8-14 | 7/8 | — | 3.31 | 84.1 | 1.96 | 49.8 | 1 |
| 12C1T-12RMJ | 7231-22215 | 3/4 | 19.0 | 1 1/16-12 | 1 1/16 | — | 3.52 | 89.4 | 1.98 | 50.3 | 1 |

Female JIC 37° Flare Swivel

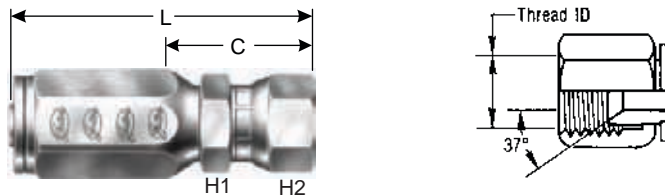

| Descr. | Prod. No. | ⊖ | | 🌀 | H1 | H2 | L | | C | | Std. Pack |
|----------------------|------------|-----|-----|---------|-------|-------|------|------|------|------|-----------|
| | | " | mm | | " | " | " | mm | " | mm | |
| STANDARD PACK | | | | | | | | | | | |
| 4C1T-4RFJX | 7231-81215 | 1/4 | 6.4 | 7/16-20 | 9/16 | 9/16 | 2.47 | 62.7 | 1.46 | 37.1 | 1 |
| 4C1T-5RFJX | 7231-81216 | 1/4 | 6.4 | 1/2-20 | 11/16 | 11/16 | 2.58 | 65.5 | 1.57 | 39.9 | 1 |
| 6C1T-6RFJX | 7231-81217 | 3/8 | 9.5 | 9/16-18 | 3/4 | 3/4 | 2.80 | 71.1 | 1.65 | 41.9 | 1 |
| 6C1T-8RFJX | 7231-81218 | 3/8 | 9.5 | 3/4-16 | 3/4 | 7/8 | 2.91 | 73.9 | 1.76 | 44.7 | 1 |



Field Attachable 'Type T' for G1 Hose (1-Wire)



Female JIC 37° Flare Swivel - Cont'd

| Descr. | Prod. No. | ⊖ | |  | H1 | H2 | L | | C | | Std. Pack |
|--------------|------------|-----|------|---|-------|--------|------|------|------|------|-----------|
| | | " | mm | | | | " | mm | " | mm | |
| 8C1T-8RFJX | 7231-81219 | 1/2 | 12.7 | 3/4-16 | 13/16 | 7/8 | 3.24 | 82.3 | 1.89 | 48.0 | 1 |
| 8C1T-10RFJX | 7231-81220 | 1/2 | 12.7 | 7/8-14 | 13/16 | 1 1/16 | 3.34 | 84.8 | 1.99 | 50.5 | 1 |
| 12C1T-12RFJX | 7231-81221 | 3/4 | 19.0 | 1 1/16-12 | 1 1/8 | 1 1/4 | 3.45 | 87.6 | 1.91 | 48.5 | 1 |
| 16C1T-16RFJX | 7231-81222 | 1 | 25.4 | 1 5/16-12 | 1 3/8 | 1 1/2 | 3.90 | 99.1 | 2.22 | 56.4 | 1 |

Female JIC 37° Flare Swivel - 45° Bent Tube

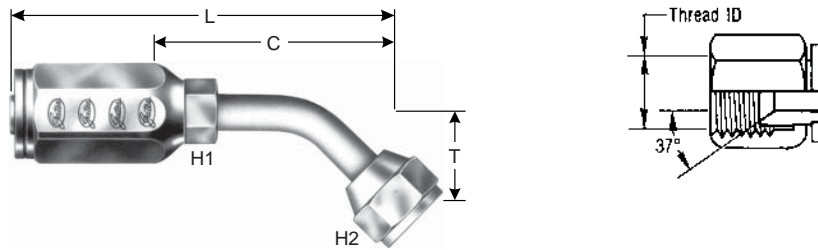

| Descr. | Prod. No. | ⊖ | |  | H1 | H2 | T | | L | | C | | Std. Pack |
|----------------------|------------|-----|------|---|-------|-------|-----|------|------|-------|------|------|-----------|
| | | " | mm | | | | " | mm | " | mm | " | mm | |
| STANDARD PACK | | | | | | | | | | | | | |
| 4C1T-4RFJX45 | 7231-22545 | 1/4 | 6.4 | 7/16-20 | 3/8 | 9/16 | .33 | 8.4 | 2.80 | 71.1 | 1.79 | 45.5 | 1 |
| 6C1T-6RFJX45 | 7231-22555 | 3/8 | 9.5 | 9/16-18 | 1/2 | 11/16 | .39 | 9.9 | 3.37 | 85.6 | 1.79 | 45.5 | 1 |
| 8C1T-8RFJX45 | 7231-22565 | 1/2 | 12.7 | 3/4-16 | 5/8 | 7/8 | .55 | 14.0 | 4.11 | 104.4 | 2.10 | 53.3 | 1 |
| 12C1T-12RFJX45 | 7231-22575 | 3/4 | 19.0 | 1 1/16-12 | 1 1/4 | 1 1/4 | .78 | 19.8 | 4.70 | 119.4 | 3.16 | 80.3 | 1 |

Female JIC 37° Flare Swivel - 90° Bent Tube

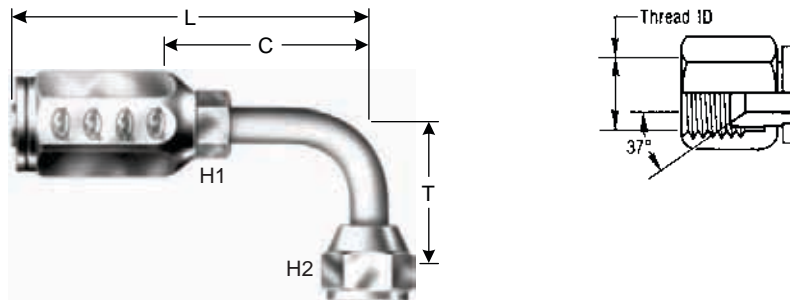

| Descr. | Prod. No. | ⊖ | |  | H1 | H2 | T | | L | | C | | Std. Pack |
|----------------------|------------|-----|------|---|-------|-------|------|------|------|-------|------|------|-----------|
| | | " | mm | | | | " | mm | " | mm | " | mm | |
| STANDARD PACK | | | | | | | | | | | | | |
| 4C1T-4RFJX90 | 7231-22655 | 1/4 | 6.4 | 7/16-20 | 3/8 | 9/16 | .68 | 17.3 | 2.69 | 68.3 | 1.68 | 42.7 | 1 |
| 6C1T-6RFJX90 | 7231-22665 | 3/8 | 9.5 | 9/16-18 | 1/2 | 11/16 | .85 | 21.6 | 3.28 | 83.3 | 2.00 | 50.8 | 1 |
| 6C1T-8RFJX90 | 7231-22675 | 3/8 | 9.5 | 3/4-16 | 5/8 | 7/8 | 1.09 | 27.7 | 3.58 | 90.9 | 2.31 | 58.7 | 1 |
| 8C1T-8RFJX90 | 7231-22685 | 1/2 | 12.7 | 3/4-16 | 5/8 | 7/8 | 1.09 | 27.7 | 3.86 | 98.0 | 2.51 | 63.8 | 1 |
| 8C1T-10RFJX90 | 7231-22695 | 1/2 | 12.7 | 7/8-14 | 3/4 | 1 | 1.23 | 31.2 | 3.92 | 99.6 | 2.59 | 65.8 | 1 |
| 12C1T-12RFJX90 | 7231-22705 | 3/4 | 19.0 | 1 1/16-12 | 1 1/4 | 1 1/4 | 1.82 | 46.2 | 4.59 | 116.6 | 3.05 | 77.5 | 1 |

EQUIPMENT

HOSE/CPLG. SELECTION

GLOBAL SPIRAL COUPLINGS

PCM/PCS FERRULES

MEGACRIMP COUPLINGS

POWER CRIMP COUPLINGS

LOW PRESSURE COUPLINGS

POLAR SEAL COUPLINGS

C14 COUPLINGS

PCTS THERMO-PLASTIC COUPLINGS

FIELD ATTACHABLE G1 & G2 COUPLINGS

FIELD ATTACHABLE C5 COUPLINGS

SURELOK AIR BRAKE COUPLINGS

QUICK DISCONNECT COUPLERS

NEW BALL VALVES

ACCESSORIES

EQUIPMENT AND PARTS





Field Attachable 'Type T' for G2 Hose (2-Wire)

Male Pipe (NPTF - 30° Cone Seat)

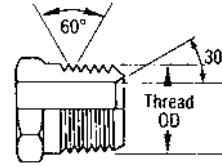
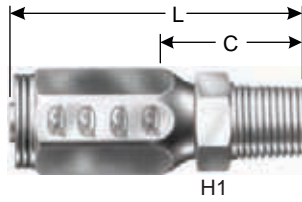

H1

| Descr. | Prod. No. | ⊖ | | 🌀 | H1 | H2 | L | | C | | Std. Pack |
|----------------------|------------|-------|------|--------------|--------|----|------|-------|------|------|-----------|
| | | " | mm | | " | " | " | mm | " | mm | |
| STANDARD PACK | | | | | | | | | | | |
| 4C2AT-2RMP | 7231-81247 | 1/4 | 6.4 | 1/8-27 | 1/2 | — | 2.30 | 58.4 | 1.23 | 31.2 | 1 |
| 4C2AT-4RMP | 7231-81223 | 1/4 | 6.4 | 1/4-18 | 9/16 | — | 2.52 | 64.0 | 1.45 | 36.8 | 1 |
| 6C2AT-4RMP | 7231-81248 | 3/8 | 9.5 | 1/4-18 | 9/16 | — | 2.68 | 68.1 | 1.45 | 36.8 | 1 |
| 6C2AT-6RMP | 7231-81224 | 3/8 | 9.5 | 3/8-18 | 11/16 | — | 2.53 | 64.3 | 1.30 | 33.0 | 1 |
| 8C2AT-6RMP | 7231-81249 | 1/2 | 12.7 | 3/8-18 | 11/16 | — | 3.05 | 77.5 | 1.63 | 41.4 | 1 |
| 8C2AT-8RMP | 7231-81225 | 1/2 | 12.7 | 1/2-14 | 7/8 | — | 3.06 | 77.7 | 1.64 | 41.6 | 1 |
| 8C2AT-12RMP | 7231-81251 | 1/2 | 12.7 | 3/4-14 | 1 1/16 | — | 3.13 | 79.5 | 1.71 | 43.4 | 1 |
| 12C2AT-12RMP | 7231-81226 | 3/4 | 19.0 | 3/4-14 | 1 1/16 | — | 3.19 | 81.0 | 1.65 | 41.9 | 1 |
| 16C2AT-16RMP | 7231-81227 | 1 | 25.4 | 1-11 1/2 | 1 3/8 | — | 3.78 | 96.0 | 2.04 | 51.8 | 1 |
| 20C2AT-20RMP | 7231-81228 | 1 1/4 | 31.8 | 1 1/4-11 1/2 | 1 3/4 | — | 4.59 | 116.6 | 2.49 | 63.2 | 1 |
| 24C2AT-24RMP | 7231-81252 | 1 1/2 | 38.1 | 1 1/2-11 1/2 | 2 | — | 5.18 | 131.6 | 2.68 | 68.1 | 1 |

Male Pipe Swivel (NPTF - Without 30° Cone Seat)

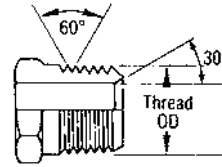
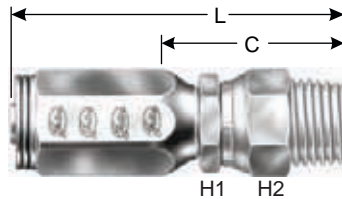

H1 H2

| Descr. | Prod. No. | ⊖ | | 🌀 | H1 | H2 | L | | C | | Std. Pack |
|----------------------|------------|-----|------|--------|--------|--------|------|-------|------|------|-----------|
| | | " | mm | | " | " | " | mm | " | mm | |
| STANDARD PACK | | | | | | | | | | | |
| 4C2AT-4RMPX | 7231-22495 | 1/4 | 6.4 | 1/4-18 | 7/16 | 11/16 | 3.18 | 80.8 | 2.11 | 53.6 | 1 |
| 6C2AT-6RMPX | 7231-22505 | 3/8 | 9.5 | 3/8-18 | 5/8 | 7/8 | 3.51 | 89.2 | 2.27 | 57.7 | 1 |
| 8C2AT-8RMPX | 7231-22515 | 1/2 | 12.7 | 1/2-14 | 3/4 | 1 | 3.99 | 101.3 | 2.56 | 65.0 | 1 |
| 12C2AT-12RMPX | 7231-22525 | 3/4 | 19.0 | 3/4-14 | 1 1/16 | 1 5/16 | 4.27 | 108.5 | 2.73 | 69.3 | 1 |

- EQUIPMENT
- HOSE/CPLG. SELECTION
- GLOBALSPIRAL COUPLINGS
- PCM/PCS FERRULES
- MEGACRIMP COUPLINGS
- POWER CRIMP COUPLINGS
- LOW PRESSURE COUPLINGS
- POLARSEAL COUPLINGS
- C14 COUPLINGS
- PCTS THERMO-PLASTIC COUPLINGS
- FIELD ATTACHABLE G1 & G2 COUPLINGS
- FIELD ATTACHABLE C5 COUPLINGS
- SURELOK AIR BRAKE COUPLINGS
- QUICK DISCONNECT COUPLERS
- NEW BALL VALVES
- ACCESSORIES
- EQUIPMENT AND PARTS



Field Attachable 'Type T' for G2 Hose (2-Wire)



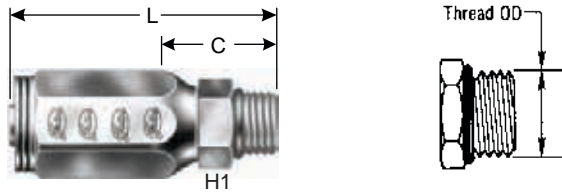

Male O-Ring Boss

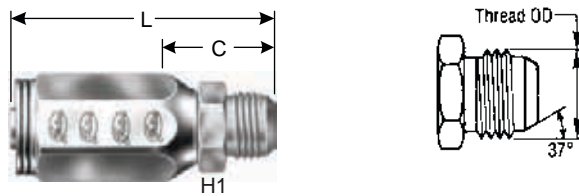

| Descr. | Prod. No. | ⊖ | |  | H1 | H2 | L | | C | | Std. Pack |
|----------------------|------------|-----|------|---|-------|----|------|------|------|------|-----------|
| | | " | mm | | | | " | mm | " | mm | |
| STANDARD PACK | | | | | | | | | | | |
| 6C2AT-6RMB | 7231-22355 | 3/8 | 9.5 | 9/16-18 | 11/16 | — | 2.52 | 64.0 | 1.28 | 32.5 | 1 |
| 6C2AT-8RMB | 7231-22365 | 3/8 | 9.5 | 3/4-16 | 7/8 | — | 2.59 | 65.8 | 1.36 | 34.5 | 1 |
| 8C2AT-8RMB | 7231-22375 | 1/2 | 12.7 | 3/4-16 | 7/8 | — | 2.87 | 72.9 | 1.45 | 36.8 | 1 |
| 8C2AT-10RMB | 7231-22385 | 1/2 | 12.7 | 7/8-14 | 1 | — | 3.11 | 79.0 | 1.59 | 40.4 | 1 |

Male JIC 37° Flare



| Descr. | Prod. No. | ⊖ | |  | H1 | H2 | L | | C | | Std. Pack |
|----------------------|------------|-----|------|---|--------|----|------|------|------|------|-----------|
| | | " | mm | | | | " | mm | " | mm | |
| STANDARD PACK | | | | | | | | | | | |
| 6C2AT-6RMJ | 7231-22025 | 3/8 | 9.5 | 9/16-18 | 9/16 | — | 2.68 | 68.1 | 1.45 | 36.8 | 1 |
| 8C2AT-8RMJ | 7231-22045 | 1/2 | 12.7 | 3/4-16 | 3/4 | — | 3.05 | 77.5 | 1.63 | 41.4 | 1 |
| 8C2AT-10RMJ | 7231-22055 | 1/2 | 12.7 | 7/8-14 | 7/8 | — | 3.31 | 84.1 | 1.89 | 48.0 | 1 |
| 12C2AT-12RMJ | 7231-22065 | 3/4 | 19.0 | 1 1/16-12 | 1 1/16 | — | 3.52 | 89.4 | 1.98 | 50.3 | 1 |

Female JIC 37° Flare Swivel

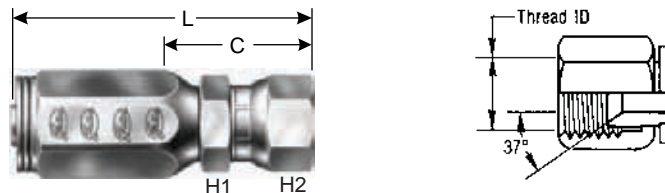

| Descr. | Prod. No. | ⊖ | |  | H1 | H2 | L | | C | | Std. Pack |
|----------------------|------------|-----|-----|---|-------|-------|------|------|------|------|-----------|
| | | " | mm | | | | " | mm | " | mm | |
| STANDARD PACK | | | | | | | | | | | |
| 4C2AT-4RFJX | 7231-81229 | 1/4 | 6.4 | 7/16-20 | 9/16 | 9/16 | 2.47 | 62.7 | 1.40 | 35.6 | 1 |
| 4C2AT-5RFJX | 7231-81230 | 1/4 | 6.4 | 1/2-20 | 11/16 | 11/16 | .68 | 17.3 | 2.58 | 65.5 | 1 |
| 6C2AT-6RFJX | 7231-81231 | 3/8 | 9.5 | 9/16-18 | 3/4 | 3/4 | 2.80 | 71.1 | 1.56 | 39.6 | 1 |
| 6C2AT-8RFJX | 7231-81232 | 3/8 | 9.5 | 3/4-16 | 3/4 | 3/4 | 2.91 | 73.9 | 1.67 | 42.4 | 1 |

| |
|---|
| EQUIPMENT |
| HOSE/CPLG. SELECTION |
| GLOBALSPIRAL COUPLINGS |
| PCM/PCS FERRULES |
| MEGACRIMP COUPLINGS |
| POWER CRIMP COUPLINGS |
| LOW PRESSURE COUPLINGS |
| POLARSEAL COUPLINGS |
| C14 COUPLINGS |
| PCTS THERMO-PLASTIC COUPLINGS |
| FIELD ATTACHABLE G1 & G2 COUPLINGS |
| FIELD ATTACHABLE C5 COUPLINGS |
| SURELOK AIR BRAKE COUPLINGS |
| QUICK DISCONNECT COUPLERS |
| NEW BALL VALVES |
| ACCESSORIES |
| EQUIPMENT AND PARTS |



Field Attachable 'Type T' for G2 Hose (2-Wire)



EQUIPMENT

HOSE/CPLG. SELECTION

GLOBALSPIRAL COUPLINGS

PCM/PCS FERRULES

MEGACRIMP COUPLINGS

POWER CRIMP COUPLINGS

LOW PRESSURE COUPLINGS

POLARSEAL COUPLINGS

C14 COUPLINGS

PCTS THERMO-PLASTIC COUPLINGS

FIELD ATTACHABLE G1 & G2 COUPLINGS

FIELD ATTACHABLE C5 COUPLINGS

SURELOK AIR BRAKE COUPLINGS

QUICK DISCONNECT COUPLERS

NEW BALL VALVES

ACCESSORIES

EQUIPMENT AND PARTS

Female JIC 37° Flare Swivel - Cont'd

| Descr. | Prod. No. | ⊖ | | | H1 | H2 | L | | C | | Std. Pack |
|---------------|------------|-------|------|-----------|-------|--------|------|-------|------|------|-----------|
| | | " | mm | | " | " | " | mm | " | mm | |
| 8C2AT-8RFJX | 7231-81233 | 1/2 | 12.7 | 3/4-16 | 13/16 | 7/8 | 3.24 | 82.3 | 1.82 | 46.2 | 1 |
| 8C2AT-10RFJX | 7231-81234 | 1/2 | 12.7 | 7/8-14 | 13/16 | 1 1/16 | 3.34 | 84.8 | 1.92 | 48.8 | 1 |
| 12C2AT-12RFJX | 7231-81235 | 3/4 | 19.0 | 1 1/16-12 | 1 1/8 | 1 1/2 | 3.45 | 87.6 | 1.91 | 48.5 | 1 |
| 16C2AT-16RFJX | 7231-81236 | 1 | 25.4 | 1 5/16-12 | 1 3/8 | 1 1/2 | 3.90 | 99.1 | 2.16 | 54.9 | 1 |
| 20C2AT-20RFJX | 7231-81237 | 1 1/4 | 31.8 | 1 5/12-12 | 1 7/8 | 2 | 4.85 | 123.2 | 2.74 | 69.6 | 1 |
| 24C2AT-24RFJX | 7231-81254 | 1 1/2 | 38.1 | 1 7/8-12 | 2 1/8 | 2 1/4 | 5.26 | 133.6 | 2.76 | 70.1 | 1 |

Female JIC 37° Flare Swivel - 45° Bent Tube

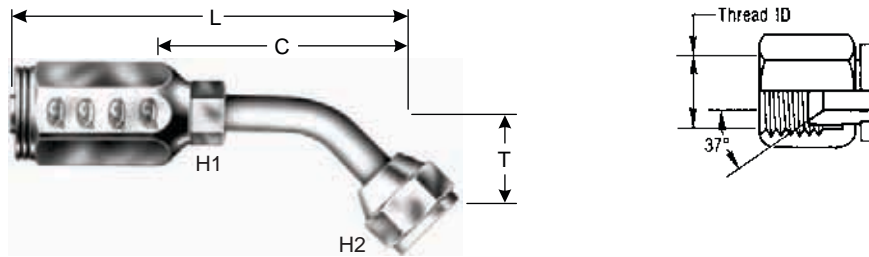

| Descr. | Prod. No. | ⊖ | | | H1 | H2 | T | | L | | C | | Std. Pack |
|----------------------|------------|-----|------|-----------|-----|-------|-----|------|------|-------|------|------|-----------|
| | | " | mm | | " | " | " | mm | " | mm | " | mm | |
| STANDARD PACK | | | | | | | | | | | | | |
| 4C2AT-4RFJX45 | 7231-22595 | 1/4 | 6.4 | 7/16-20 | 3/8 | 9/16 | .33 | 8.4 | 2.80 | 71.1 | 1.73 | 43.9 | 1 |
| 6C2AT-6RFJX45 | 7231-22605 | 3/8 | 9.5 | 9/16-18 | 1/2 | 11/16 | .39 | 9.9 | 3.37 | 85.6 | 2.14 | 54.4 | 1 |
| 8C2AT-8RFJX45 | 7231-22615 | 1/2 | 12.7 | 3/4-16 | 5/8 | 7/8 | .55 | 14.0 | 4.11 | 104.4 | 2.68 | 68.1 | 1 |
| 12C2AT-12RFJX45 | 7231-22625 | 3/4 | 19.0 | 1 1/16-12 | 7/8 | 1 1/4 | .78 | 19.8 | 4.70 | 119.4 | 3.16 | 80.3 | 1 |

Female JIC 37° Flare Swivel - 90° Bent Tube

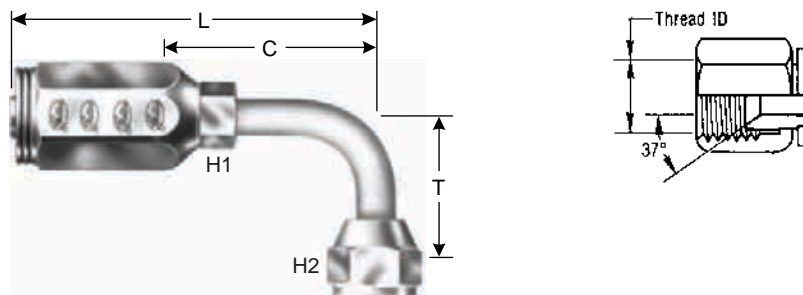

| Descr. | Prod. No. | ⊖ | | | H1 | H2 | T | | L | | C | | Std. Pack |
|----------------------|------------|-----|------|-----------|-----|-------|------|------|------|-------|------|------|-----------|
| | | " | mm | | " | " | " | mm | " | mm | " | mm | |
| STANDARD PACK | | | | | | | | | | | | | |
| 4C2AT-4RFJX90 | 7231-22755 | 1/4 | 6.4 | 7/16-20 | 3/8 | 9/16 | .68 | 17.3 | 2.69 | 68.3 | 1.62 | 41.1 | 1 |
| 6C2AT-6RFJX90 | 7231-22765 | 3/8 | 9.5 | 9/16-18 | 1/2 | 11/16 | .85 | 21.6 | 3.28 | 83.3 | 2.04 | 51.8 | 1 |
| 6C2AT-8RFJX90 | 7231-22775 | 3/8 | 9.5 | 3/4-16 | 5/8 | 7/8 | 1.09 | 27.7 | 3.58 | 90.9 | 2.35 | 59.7 | 1 |
| 8C2AT-8RFJX90 | 7231-22785 | 1/2 | 12.7 | 3/4-16 | 5/8 | 7/8 | 1.09 | 27.7 | 3.86 | 98.0 | 2.42 | 61.5 | 1 |
| 8C2AT-10RFJX90 | 7231-22795 | 1/2 | 12.7 | 7/8-14 | 3/4 | 1 | 1.23 | 31.2 | 3.92 | 99.6 | 2.50 | 63.5 | 1 |
| 12C2AT-12RFJX90 | 7231-22805 | 3/4 | 19.0 | 1 1/16-12 | 7/8 | 1 1/4 | 1.82 | 46.2 | 4.59 | 116.6 | 3.05 | 77.5 | 1 |





Field Attachable 'Type T' for G2 Hose (2-Wire)

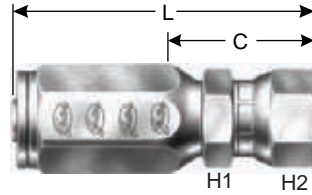

Female Flat-Face O-Ring Swivel

SAE J1453 O-Ring Face Seal.



| Descr. | Prod. No. | ⊖ | |  | H1 | H2 | L | | C | | Std. Pack |
|----------------------|------------|-----|------|---|-------|---------|------|------|------|------|-----------|
| | | " | mm | | | | " | mm | " | mm | |
| STANDARD PACK | | | | | | | | | | | |
| 4C2AT-4RFFORX | 7231-14105 | 1/4 | 6.4 | 9/16-18 | 43/64 | 43/64 | 2.50 | 63.5 | 1.43 | 36.3 | 1 |
| 6C2AT-6RFFORX | 7231-14125 | 3/8 | 9.5 | 11/16-16 | 7/8 | 7/8 | 2.88 | 73.1 | 1.64 | 41.7 | 1 |
| 8C2AT-8RFFORX | 7231-14145 | 1/2 | 12.7 | 13/16-16 | 61/64 | 61/64 | 3.37 | 85.6 | 1.94 | 42.3 | 1 |
| 12C2AT-12RFFORX | 7231-14165 | 3/4 | 19.1 | 1 13/16-16 | 1 1/8 | 1 13/32 | 2.03 | 51.6 | 3.57 | 90.7 | 1 |

Female Flat-Face O-Ring Swivel - 45° Bent Tube

SAE J1453 O-Ring Face Seal.

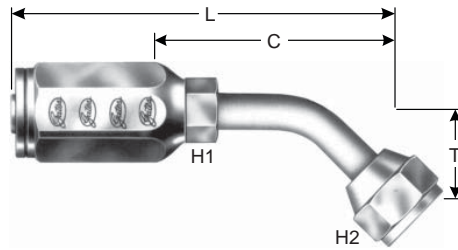

| Descr. | Prod. No. | ⊖ | |  | H1 | H2 | T | L | | C | | Std. Pack | |
|----------------------|------------|-----|------|---|-----|-------|------|------|------|-------|------|-----------|---|
| | | " | mm | | | | | " | mm | " | mm | | |
| STANDARD PACK | | | | | | | | | | | | | |
| 4C2AT-4RFFORX45S | 7231-14305 | 1/4 | 6.4 | 9/16-18 | 3/8 | 9/16 | .68 | 17.3 | 2.69 | 68.3 | 1.62 | 41.1 | 1 |
| 6C2AT-6RFFORX45S | 7231-14325 | 3/8 | 9.5 | 11/16-16 | 1/2 | 11/16 | .85 | 21.6 | 3.28 | 83.3 | 2.04 | 51.8 | 1 |
| 8C2AT-8RFFORX45S | 7231-14345 | 1/2 | 12.7 | 13/16-16 | 5/8 | 7/8 | 1.09 | 27.7 | 3.86 | 98.0 | 2.42 | 61.5 | 1 |
| 12C2AT-12RFFORX45S | 7231-14365 | 3/4 | 19.1 | 1 13/16-12 | 7/8 | 1 1/4 | 1.82 | 46.2 | 4.59 | 116.6 | 3.05 | 77.5 | 1 |

EQUIPMENT

HOSE/CPLG. SELECTION

GLOBALSPIRAL COUPLINGS

PCM/PCS FERRULES

MEGACRIMP COUPLINGS

POWER CRIMP COUPLINGS

LOW PRESSURE COUPLINGS

POLARSEAL COUPLINGS

C14 COUPLINGS

PCTS THERMO-PLASTIC COUPLINGS

FIELD ATTACHABLE G1 & G2 COUPLINGS

FIELD ATTACHABLE C5 COUPLINGS

SURELOK AIR BRAKE COUPLINGS

QUICK DISCONNECT COUPLERS

NEW BALL VALVES

ACCESSORIES

EQUIPMENT AND PARTS







Field Attachable 'Type T' for G2 Hose (2-Wire)

Female Flat-Face O-Ring Swivel - 90° Bent Tube

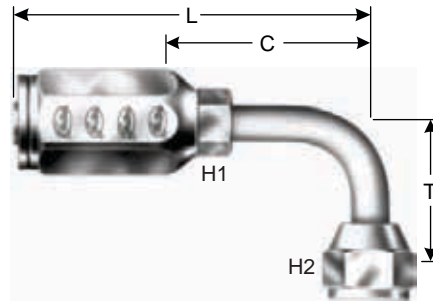
SAE J1453 O-Ring Face Seal.



| Descr. | Prod. No. | ⊖ | |  | H1 | H2 | T | | L | | C | | Std. Pack |
|----------------------|------------|-----|------|---|-----|-------|------|------|------|------|------|------|-----------|
| | | " | mm | | " | " | " | mm | " | mm | " | mm | |
| STANDARD PACK | | | | | | | | | | | | | |
| 4C2AT-4RFFORX90S | 7231-14505 | 1/4 | 6.4 | 9/16-18 | 3/8 | 9/16 | .68 | 17.3 | 2.69 | 68.3 | 1.62 | 41.1 | 1 |
| 6C2AT-6RFFORX90S | 7231-14525 | 3/8 | 9.5 | 11/16-16 | 1/2 | 11/16 | .85 | 21.6 | 3.28 | 83.3 | 2.04 | 51.8 | 1 |
| 8C2AT-8RFFORX90S | 7231-14545 | 1/2 | 12.7 | 13/16-16 | 5/8 | 7/8 | 1.09 | 27.7 | 3.86 | 98.0 | 2.42 | 61.5 | 1 |

| |
|---|
| EQUIPMENT |
| HOSE/CPLG. SELECTION |
| GLOBALSPIRAL COUPLINGS |
| PCM/PCS FERRULES |
| MEGACRIMP COUPLINGS |
| POWER CRIMP COUPLINGS |
| LOW PRESSURE COUPLINGS |
| POLARSEAL COUPLINGS |
| C14 COUPLINGS |
| PCTS THERMO-PLASTIC COUPLINGS |
| FIELD ATTACHABLE G1 & G2 COUPLINGS |
| FIELD ATTACHABLE C5 COUPLINGS |
| SURELOK AIR BRAKE COUPLINGS |
| QUICK DISCONNECT COUPLERS |
| NEW BALL VALVES |
| ACCESSORIES |
| EQUIPMENT AND PARTS |



Field Attachable Type T Reusable Stems and Sockets (1 and 2 - Wire)



NPTF Solid Male Stem Only (1 and 2 Wire)



| Descr. | Prod. No. | | | Std. Pack |
|------------------|-----------|-----|--------|-----------|
| | | " | | |
| BULK PACK | | | | |
| 4-2RTMPXBULK | 7231-2021 | 1/4 | 1/8-27 | 25 |
| 4-4RTMPXBULK | 7231-2022 | 1/4 | 1/4-18 | 50 |
| 6-6RTMPXBULK | 7231-2024 | 3/8 | 3/8-18 | 25 |
| 8-8RTMPXBULK | 7231-2026 | 1/2 | 1/2-14 | 50 |
| 12-12RTMPXBULK | 7231-2028 | 3/4 | 3/4-14 | 25 |

JIC Swivel Female Stem Only (1 and 2 Wire)

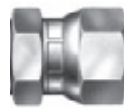

| Descr. | Prod. No. | | | Std. Pack |
|------------------|-----------|-----|-----------|-----------|
| | | " | | |
| BULK PACK | | | | |
| 4-4RTFJX XBULK | 7231-2030 | 1/4 | 7/16-20 | 25 |
| 6-6RTFJX XBULK | 7231-2032 | 3/8 | 9/16-18 | 25 |
| 8-8RTFJX XBULK | 7231-2034 | 1/2 | 3/4-16 | 25 |
| 12-12RTFJX XBULK | 7231-2036 | 3/4 | 1 1/16-12 | 25 |

Sockets for 1 Wire Only



| Descr. | Prod. No. | | Std. Pack |
|------------------|-----------|-----|-----------|
| | | " | |
| BULK PACK | | | |
| 4C1TFXBULK | 7231-2039 | 1/4 | 50 |
| 6C1TFXBULK | 7231-2040 | 3/8 | 50 |
| 8C1TFXBULK | 7231-2041 | 1/2 | 40 |
| 12C1TFXBULK | 7231-2042 | 3/4 | 50 |

EQUIPMENT

HOSE/CPLG. SELECTION

GLOBALSPIRAL COUPLINGS

PCM/PCS FERRULES

MEGACRIMP COUPLINGS

POWER CRIMP COUPLINGS

LOW PRESSURE COUPLINGS

POLARSEAL COUPLINGS

C14 COUPLINGS

PCTS THERMO-PLASTIC COUPLINGS

FIELD ATTACHABLE G1 & G2 COUPLINGS

FIELD ATTACHABLE C5 COUPLINGS

SURELOK AIR BRAKE COUPLINGS

QUICK DISCONNECT COUPLERS

NEW BALL VALVES

ACCESSORIES

EQUIPMENT AND PARTS

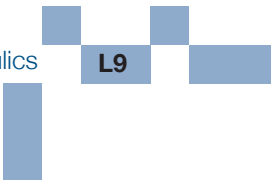

Field Attachable Type T Reusable Stems and Sockets (1 and 2 - Wire)

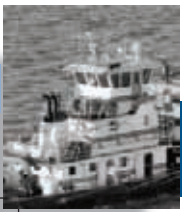

Sockets for 2 Wire Only



| Descr. | Prod. No. | ⊖ | Std. Pack |
|------------------|-----------|-----|-----------|
| | | " | |
| BULK PACK | | | |
| 4C2ATFXBULK | 7231-2082 | 1/4 | 200 |
| 6C2ATFXBULK | 7231-2083 | 3/8 | 50 |
| 8C2ATFXBULK | 7231-2084 | 1/2 | 50 |
| 12C2ATFXBULK | 7231-2085 | 3/4 | 50 |
| 16C2ATFXBULK | 7231-2086 | 1 | 25 |

| |
|---|
| EQUIPMENT |
| HOSE/CPLG. SELECTION |
| GLOBALSPIRAL COUPLINGS |
| PCM/PCS FERRULES |
| MEGACRIMP COUPLINGS |
| POWER CRIMP COUPLINGS |
| LOW PRESSURE COUPLINGS |
| POLARSEAL COUPLINGS |
| C14 COUPLINGS |
| PCTS THERMO-PLASTIC COUPLINGS |
| FIELD ATTACHABLE G1 & G2 COUPLINGS |
| FIELD ATTACHABLE C5 COUPLINGS |
| SURELOK AIR BRAKE COUPLINGS |
| QUICK DISCONNECT COUPLERS |
| NEW BALL VALVES |
| ACCESSORIES |
| EQUIPMENT AND PARTS |

