

# C14 Couplings

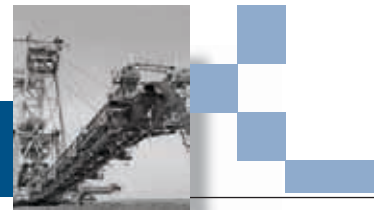

## Male Pipe (NPTF - 30° Cone Seat) - Stainless Steel

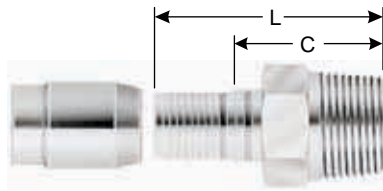

H1

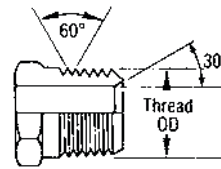

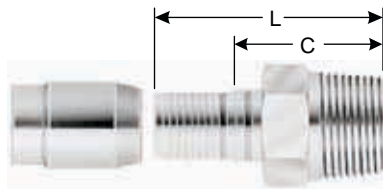

Descr.	Prod. No.	⊖			H1	H2	L		C		Std. Pack
		"	mm				"	mm	"	mm	
<b>STANDARD PACK</b>											
4C14-2MP-SS	7753-00085	3/16	4.8	1/8-27	7/16	—	1.26	32.0	.81	20.6	1
4C14-4MP-SS	7753-00015	3/16	4.8	1/4-18	9/16	—	1.47	37.3	1.02	25.9	1
5C14-4MP-SS	7753-00025	1/4	6.3	1/4-18	9/16	—	1.47	37.3	1.02	25.9	1
6C14-4MP-SS	7753-00095	5/16	7.9	1/4-18	9/16	—	1.60	40.6	1.05	26.7	1
6C14-6MP-SS	7753-00035	5/16	7.9	3/8-18	11/16	—	1.63	41.4	1.08	27.4	1
8C14-6MP-SS	7753-00105	13/32	10.3	3/8-18	11/16	—	1.68	42.7	1.07	27.2	1
8C14-8MP-SS	7753-00045	13/32	10.3	1/2-14	7/8	—	1.93	49.0	1.32	33.5	1
10C14-8MP-SS	7753-00055	1/2	12.7	1/2-14	7/8	—	2.05	52.1	1.35	34.3	1
12C14-12MP-SS	7753-00065	5/8	15.9	3/4-14	1 1/16	—	2.21	56.1	1.44	36.6	1
16C14-16MP-SS	7753-00075	7/8	22.2	1-11 1/2	1 3/8	—	2.56	65.0	1.65	41.9	1

## Male Pipe (NPTF - 30° Cone Seat) - Brass

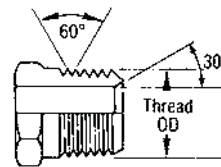

H1



Descr.	Prod. No.	⊖			H1	H2	L		C		Std. Pack
		"	mm				"	mm	"	mm	
<b>STANDARD PACK</b>											
4C14-2MP-B	7753-10085	3/16	4.8	1/8-27	7/16	—	1.26	32.0	.81	20.6	1
4C14-4MP-B	7753-10015	3/16	4.8	1/4-18	9/16	—	1.47	37.3	1.02	25.9	1
5C14-4MP-B	7753-10025	1/4	6.3	1/4-18	9/16	—	1.47	37.3	1.02	25.9	1
6C14-4MP-B	7753-10095	5/16	7.9	1/4-18	9/16	—	1.60	40.6	1.05	26.7	1
6C14-6MP-B	7753-10035	5/16	7.9	3/8-18	11/16	—	1.63	41.4	1.08	27.4	1
8C14-6MP-B	7753-10105	13/32	10.3	3/8-18	11/16	—	1.68	42.7	1.07	27.2	1
8C14-8MP-B	7753-10045	13/32	10.3	1/2-14	7/8	—	1.93	49.0	1.32	33.5	1
10C14-8MP-B	7753-10055	1/2	12.7	1/2-14	7/8	—	2.05	52.1	1.35	34.3	1
12C14-12MP-B	7753-10065	5/8	15.9	3/4-14	1 1/16	—	2.21	56.1	1.44	36.6	1
16C14-16MP-B	7753-10075	7/8	22.2	1-11 1/2	1 3/8	—	2.56	65.0	1.65	41.9	1

EQUIPMENT

HOSE/CPLG. SELECTION

GLOBALSPIRAL COUPLINGS

PCM/PCS FERRULES

MEGACRIMP COUPLINGS

POWER CRIMP COUPLINGS

LOW PRESSURE COUPLINGS

POLARSEAL COUPLINGS

**C14 COUPLINGS**

PCTS THERMO-PLASTIC COUPLINGS

FIELD ATTACHABLE G1 & G2 COUPLINGS

FIELD ATTACHABLE C5 COUPLINGS

SURELOK AIR BRAKE COUPLINGS

QUICK DISCONNECT COUPLERS

NEW BALL VALVES

ACCESSORIES

EQUIPMENT AND PARTS





# C14 Couplings

## Female JIC 37° Flare Swivel - Stainless Steel

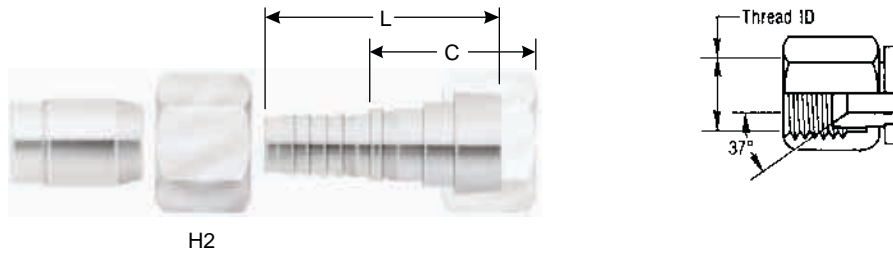

H2

Descr.	Prod. No.	⊖		🌀	H1	H2	L		C		Std. Pack
		"	mm		"	"	"	mm	"	mm	
<b>STANDARD PACK</b>											
6C14-6FJX-SS	7753-00145	5/16	7.9	9/16-18	—	3/4	1.19	30.2	1.01	25.6	1
12C14-12FJX-SS	7753-00175	5/8	15.9	1 1/16-12	—	1 1/4	1.56	39.6	1.36	34.5	1

## Female JIC 37° Flare Swivel - Brass

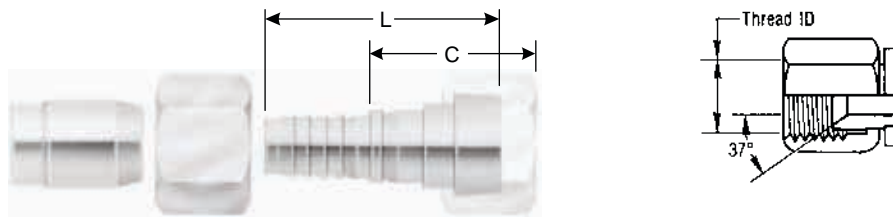

H2

Descr.	Prod. No.	⊖		🌀	H1	H2	L		C		Std. Pack
		"	mm		"	"	"	mm	"	mm	
<b>STANDARD PACK</b>											
6C14-6FJX-B	7753-10145	5/16	7.9	9/16-18	—	3/4	1.19	30.2	1.01	25.6	1
12C14-12FJX-B	7753-10175	5/8	15.9	1 1/16-12	—	1 1/4	1.56	39.6	1.36	34.5	1

## Female JIC 37° Flare Swivel - 45° Bent Tube - Steel

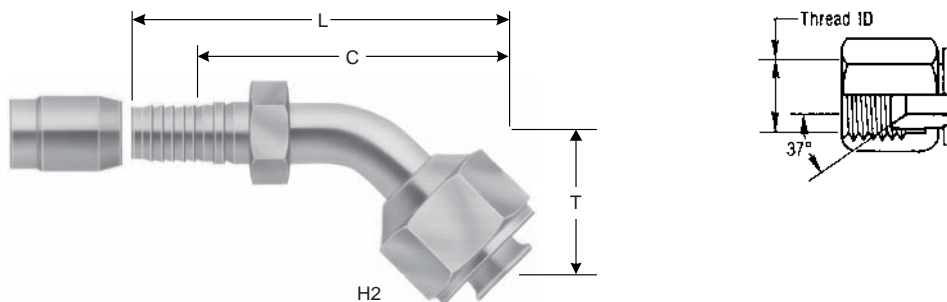

H2

Descr.	Prod. No.	⊖		🌀	H1	H2	T	L		C		Std. Pack	
		"	mm		"	"	"	mm	"	mm			
<b>STANDARD PACK</b>													
4C14-4FJX45	7753-20495	3/16	4.8	7/16-20	—	9/16	.41	10.4	1.69	42.9	1.25	31.8	1



# C14 Couplings



## Female JIC 37° Flare Swivel - 45° Bent Tube - Steel - Cont'd

Descr.	Prod. No.	⊖			H1	H2	T		L		C		Std. Pack
		"	mm		"	"	"	mm	"	mm	"	mm	
5C14-5FJX45	7753-20505	1/4	6.3	1/2-20	—	5/8	.49	12.4	1.85	47.0	1.44	36.6	1
6C14-6FJX45	7753-20515	5/16	7.9	9/16-18	—	11/16	.55	14.0	2.13	54.1	1.62	41.1	1
8C14-8FJX45	7753-20525	13/32	10.3	3/4-16	—	7/8	.63	16.0	2.44	62.0	1.88	47.8	1
10C14-10FJX45	7753-20535	1/2	12.7	7/8-14	—	1	.75	19.1	2.78	70.6	2.08	52.8	1
12C14-12FJX45	7753-20545	5/8	15.9	1 1/16-12	—	1 1/4	.90	22.9	3.92	99.6	3.15	80.0	1
16C14-16FJX45	7753-20555	7/8	22.2	1 5/16-12	—	1 1/2	1.13	28.7	4.77	121.2	3.86	98.0	1

## Female JIC 37° Flare Swivel - 90° Bent Tube - Steel

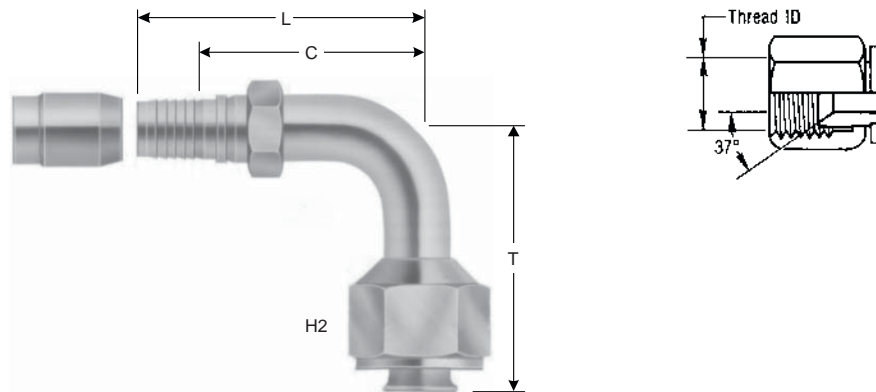

Descr.	Prod. No.	⊖			H1	H2	T		L		C		Std. Pack
		"	mm		"	"	"	mm	"	mm	"	mm	
<b>STANDARD PACK</b>													
4C14-4FJX90	7753-20565	3/16	4.8	7/16-20	—	9/16	.71	18.0	1.42	36.1	1.00	25.4	1
5C14-5FJX90	7753-20575	1/4	6.3	1/2-20	—	5/8	.88	22.4	1.55	39.4	1.06	26.9	1
6C14-6FJX90	7753-20585	5/16	7.9	9/16-18	—	11/16	1.00	25.4	1.80	45.7	1.25	31.8	1
8C14-8FJX90	7753-20595	13/32	10.3	3/4-16	—	7/8	1.18	30.0	2.10	53.3	1.50	38.1	1
10C14-10FJX90	7753-20605	1/2	12.7	7/8-14	—	1	1.50	38.1	2.47	62.7	1.81	46.0	1
12C14-12FJX90	7753-20615	5/8	15.9	1 1/16-12	—	1 1/4	2.00	50.8	3.88	98.5	3.11	79.0	1
16C14-16FJX90	7753-20625	7/8	22.2	1 5/16-12	—	1 1/2	2.48	63.0	4.64	117.8	3.73	94.7	1

EQUIPMENT
HOSE/CPLG. SELECTION
GLOBALSPIRAL COUPLINGS
PCM/PCS FERRULES
MEGACRIMP COUPLINGS
POWER CRIMP COUPLINGS
LOW PRESSURE COUPLINGS
POLARSEAL COUPLINGS
<b>C14 COUPLINGS</b>
PCTS THERMO-PLASTIC COUPLINGS
FIELD ATTACHABLE G1 & G2 COUPLINGS
FIELD ATTACHABLE C5 COUPLINGS
SURELOK AIR BRAKE COUPLINGS
QUICK DISCONNECT COUPLERS
NEW BALL VALVES
ACCESSORIES
EQUIPMENT AND PARTS





# C14 Couplings

## Dual Seat Female JIC 37°/SAE 45° Flare Swivel - Stainless Steel

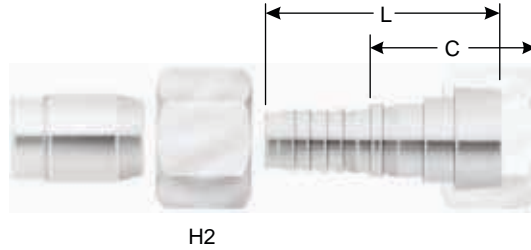

Descr.	Prod. No.	⊖		🌀	H1	H2	L		C		Std. Pack
		"	mm		"	"	"	mm	"	mm	
<b>STANDARD PACK</b>											
4C14-4FJSX-SS	7753-00125	3/16	4.8	7/16-20	—	9/16	.95	24.1	.87	22.1	1
5C14-5FJSX-SS	7753-00135	1/4	6.4	1/2-20	—	11/16	1.01	25.6	.94	23.9	1
8C14-8FJSX-SS	7753-00155	13/32	10.3	3/4-16	—	7/8	1.30	33.0	1.13	28.7	1
10C14-10FJSX-SS	7753-00165	1/2	12.7	7/8-14	—	1 1/16	1.47	37.3	1.29	32.8	1
16C14-16FJSX-SS	7753-00185	7/8	22.2	1 5/16-12	—	1 1/2	1.75	44.5	1.46	37.1	1

## Dual Seat Female JIC 37°/SAE 45° Flare Swivel - Brass

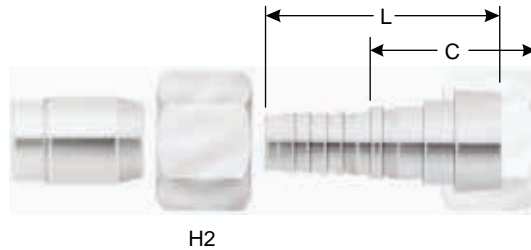

Descr.	Prod. No.	⊖		🌀	H1	H2	L		C		Std. Pack
		"	mm		"	"	"	mm	"	mm	
<b>STANDARD PACK</b>											
4C14-4FJSX-B	7753-10125	3/16	4.8	7/16-20	—	9/16	.95	24.1	.79	20.1	1
5C14-5FJSX-B	7753-10135	1/4	6.4	1/2-20	—	11/16	1.01	25.6	.94	23.9	1
8C14-8FJSX-B	7753-10155	13/32	10.3	3/4-16	—	7/8	1.30	33.0	1.13	28.7	1
10C14-10FJSX-B	7753-10165	1/2	12.7	7/8-14	—	1 1/16	1.47	37.3	1.29	32.8	1
16C14-16FJSX-B	7753-10185	7/8	22.2	1 5/16-12	—	1 1/2	1.75	44.5	1.46	37.1	1

- EQUIPMENT
- HOSE/CPLG. SELECTION
- GLOBALSPIRAL COUPLINGS
- PCM/PCS FERRULES
- MEGACRIMP COUPLINGS
- POWER CRIMP COUPLINGS
- LOW PRESSURE COUPLINGS
- POLARSEAL COUPLINGS
- C14 COUPLINGS**
- PCTS THERMO-PLASTIC COUPLINGS
- FIELD ATTACHABLE G1 & G2 COUPLINGS
- FIELD ATTACHABLE C5 COUPLINGS
- SURELOK AIR BRAKE COUPLINGS
- QUICK DISCONNECT COUPLERS
- NEW BALL VALVES
- ACCESSORIES
- EQUIPMENT AND PARTS





## Female SAE 45° Flare Swivel - Brass

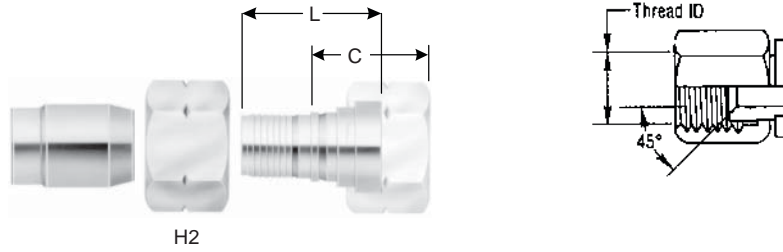

Descr.	Prod. No.	⊖		🌀	H1	H2	L		C		Std. Pack
		"	mm				"	mm	"	mm	
<b>STANDARD PACK</b>											
6C14-6FSX-B	7753-10195	5/16	7.9	5/8-18	—	3/4	1.19	30.2	1.01	25.6	1
12C14-12FSX-B	7753-10205	5/8	15.9	1 1/16-14	—	1 1/4	1.56	39.6	1.36	34.5	1

## Female SAE 45° Flare Swivel - 45° Bent Tube - Steel

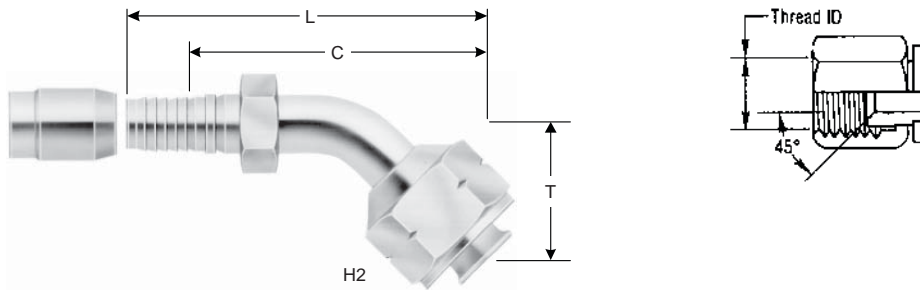

Descr.	Prod. No.	⊖		🌀	H1	H2	T	L		C		Std. Pack	
		"	mm					"	mm	"	mm		
<b>STANDARD PACK</b>													
4C14-4FSX45	7753-20215	3/16	4.8	7/16-20	—	9/16	.41	10.4	1.69	42.9	1.25	31.8	1
5C14-5FSX45	7753-20225	1/4	6.3	1/2-20	—	5/8	.49	12.4	1.85	47.0	1.44	36.6	1
6C14-6FSX45	7753-20235	5/16	7.9	5/8-18	—	3/4	.55	14.0	2.13	54.1	1.62	41.1	1
8C14-8FSX45	7753-20245	13/32	10.3	3/4-16	—	7/8	.63	16.0	2.44	62.0	1.88	47.8	1
10C14-10FSX45	7753-20635	1/2	12.7	7/8-14	—	1	.75	19.1	2.78	70.6	2.12	53.8	1
12C14-12FSX45	7753-20645	5/8	15.9	1 1/16-14	—	1 1/4	.90	22.9	3.92	99.6	3.15	80.0	1

EQUIPMENT

HOSE/CPLG. SELECTION

GLOBALSPIRAL COUPLINGS

PCM/PCS FERRULES

MEGACRIMP COUPLINGS

POWER CRIMP COUPLINGS

LOW PRESSURE COUPLINGS

POLARSEAL COUPLINGS

C14 COUPLINGS

PCTS THERMO-PLASTIC COUPLINGS

FIELD ATTACHABLE G1 &amp; G2 COUPLINGS

FIELD ATTACHABLE C5 COUPLINGS

SURELOK AIR BRAKE COUPLINGS

QUICK DISCONNECT COUPLERS

NEW BALL VALVES

ACCESSORIES

EQUIPMENT AND PARTS



# C14 Couplings

## Female SAE 45° Flare Swivel - 90° Bent Tube - Steel

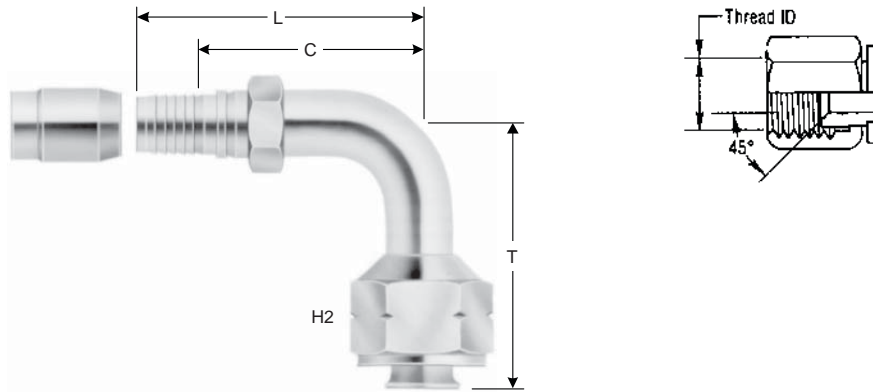

Descr.	Prod. No.	⊖		🌀	H1	H2	T		L		C		Std. Pack
		"	mm		"	"	"	mm	"	mm	"	mm	
<b>STANDARD PACK</b>													
4C14-4FSX90	7753-20255	3/16	4.8	7/16-20	—	9/16	.71	18.0	1.42	36.1	1.00	25.4	1
5C14-5FSX90	7753-20265	1/4	6.3	1/2-20	—	5/8	.88	22.4	1.55	39.4	1.06	26.9	1
6C14-6FSX90	7753-20275	5/16	7.9	5/8-18	—	3/4	1.00	25.4	1.80	45.7	1.25	31.8	1
8C14-8FSX90	7753-20285	13/32	10.3	3/4-16	—	7/8	1.18	30.0	2.10	53.3	1.50	38.1	1
10C14-10FSX90	7753-20295	1/2	12.7	7/8-14	—	1 1/16	1.50	38.1	2.47	62.7	1.81	46.0	1
12C14-12FSX90	7753-20665	5/8	15.9	1 1/16-14	—	1 1/4	2.00	50.8	3.88	98.5	3.11	79.0	1

## Air Brake Compression - Brass

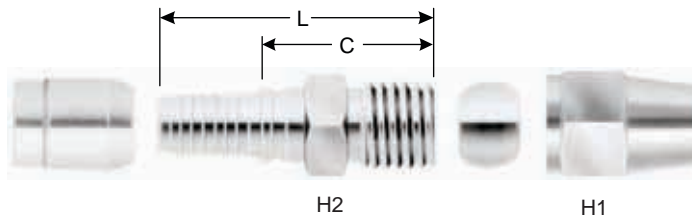

Descr.	Prod. No.	⊖		🌀	H1	H2	L		C		⊖	Std. Pack
		"	mm		"	"	"	mm	"	mm		
<b>STANDARD PACK</b>												
8C14-8ABC-B	7753-10365	13/32	10.3	11/16-20	7/8	13/16	1.71	43.4	1.10	27.9	.50	1
10C14-10ABC-B	7753-10385	1/2	12.7	13/16-18	7/8	15/16	1.89	48.0	1.19	30.2	.63	1
12C14-12ABC-B	7753-10395	5/8	15.9	1-18	1 1/16	1 1/8	2.13	54.1	1.36	34.5	.75	1



## Straight Tube Assembly - Brass

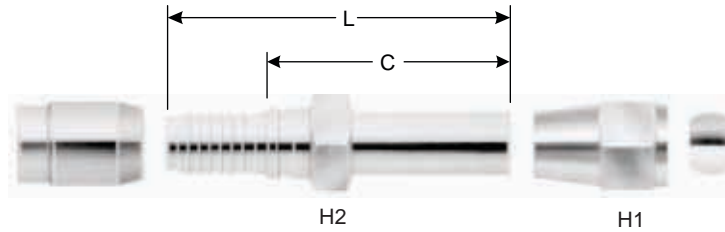

Descr.	Prod. No.	⊖			H1	H2	L		C			Std. Pack
		"	mm		"	"	"	mm	"	mm		
<b>STANDARD PACK</b>												
10C14-8STA-B	7753-10415	1/2	12.7	11/16-20	3/4	13/16	3.18	80.8	2.21	56.1	.5	1
10C14-10STA-B	7753-10425	1/2	12.7	13/16-18	3/4	15/16	3.50	88.9	2.53	64.3	.63	1
12C14-12STA-B	7753-10435	5/8	15.9	1-18	7/8	1 1/8	3.67	93.2	2.61	66.3	.75	1

## SAE Male Inverted Swivel - Steel

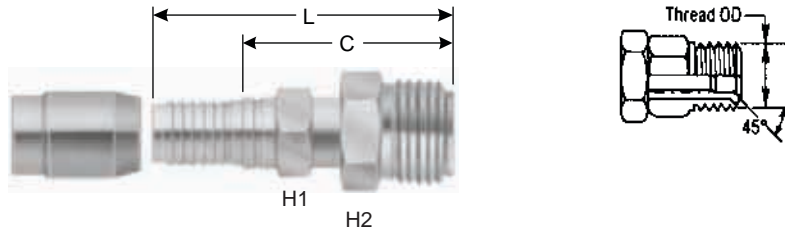

Descr.	Prod. No.	⊖			H1	H2	L		C		Std. Pack
		"	mm		"	"	"	mm	"	mm	
<b>STANDARD PACK</b>											
4C14-4MIX	7753-20305	3/16	4.8	7/16-24	7/16	7/16	1.84	46.7	1.39	35.3	1
5C14-5MIX	7753-20315	1/4	6.3	1/2-20	1/2	1/2	1.90	48.3	1.45	36.8	1
6C14-6MIX	7753-20325	5/16	7.9	5/8-18	9/16	5/8	2.07	52.6	1.52	38.6	1
8C14-8MIX	7753-20335	13/32	10.3	3/4-12	5/8	3/4	2.21	56.1	1.60	40.6	1
10C14-10MIX	7753-20345	1/2	12.7	7/8-16	3/4	7/8	2.47	62.7	1.77	45.0	1

EQUIPMENT

HOSE/CPLG. SELECTION

GLOBALSPIRAL COUPLINGS

PCM/PCS FERRULES

MEGACRIMP COUPLINGS

POWER CRIMP COUPLINGS

LOW PRESSURE COUPLINGS

POLARSEAL COUPLINGS

C14 COUPLINGS

PCTS THERMO-PLASTIC COUPLINGS

FIELD ATTACHABLE G1 &amp; G2 COUPLINGS

FIELD ATTACHABLE C5 COUPLINGS

SURELOK AIR BRAKE COUPLINGS

QUICK DISCONNECT COUPLERS

NEW BALL VALVES

ACCESSORIES

EQUIPMENT AND PARTS





# C14 Couplings

## SAE Male Inverted Swivel - 45° Bent Tube - Steel

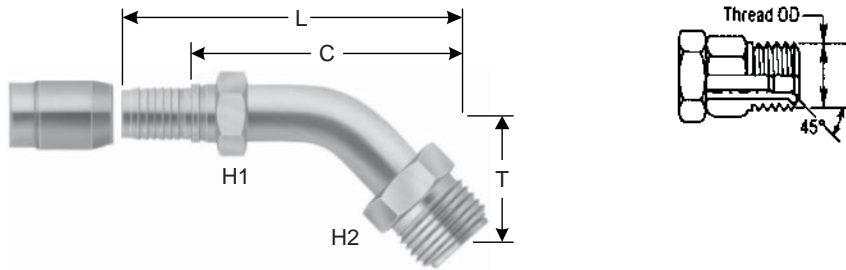

Descr.	Prod. No.	⊖		🌀	H1	H2	T		L		C		Std. Pack
		"	mm		"	"	"	mm	"	mm	"	mm	
<b>STANDARD PACK</b>													
4C14-4MIX45	7753-20355	3/16	4.8	7/16-24	7/16	7/16	.73	18.5	1.99	50.5	1.53	38.9	1
6C14-6MIX45	7753-20365	5/16	7.9	5/8-18	9/16	5/8	.94	23.9	2.48	63.0	1.93	49.0	1
8C14-8MIX45	7753-20375	13/32	10.3	3/4-16	5/8	3/4	1.14	28.9	2.95	74.9	2.10	53.3	1
10C14-10MIX45	7753-20695	1/2	12.7	7/8-18	3/4	7/8	1.34	34.0	3.37	85.6	2.67	67.8	1
12C14-12MIX45	7753-20705	5/8	15.9	1 3/16-16	7/8	1 1/16	1.54	39.1	4.56	115.8	3.79	96.3	1

## SAE Male Inverted Swivel - 90° Bent Tube - Steel

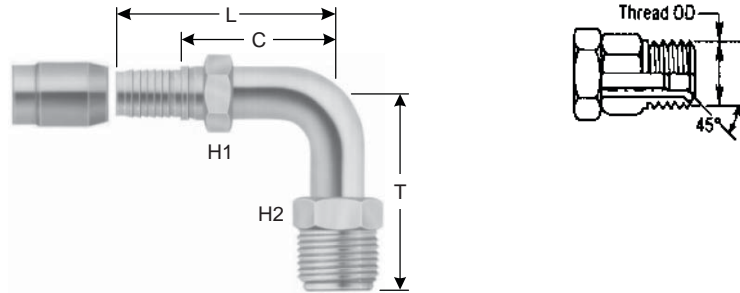

Descr.	Prod. No.	⊖		🌀	H1	H2	T		L		C		Std. Pack
		"	mm		"	"	"	mm	"	mm	"	mm	
<b>STANDARD PACK</b>													
4C14-4MIX90	7753-20385	3/16	4.8	7/16-24	7/16	7/16	1.30	33.0	1.42	36.1	.97	24.6	1
5C14-5MIX90	7753-20395	1/4	6.3	1/2-20	1/2	1/2	1.48	37.6	1.54	39.1	1.09	27.7	1
6C14-6MIX90	7753-20405	5/16	7.9	5/8-18	9/16	5/8	1.63	41.4	1.80	45.7	1.25	31.8	1
8C14-8MIX90	7753-20415	13/32	10.3	3/4-16	5/8	3/4	1.91	48.5	2.10	53.3	1.77	45.0	1
10C14-10MIX90	7753-20425	1/2	12.7	7/8-18	3/4	7/8	2.16	54.9	2.47	62.7	1.77	45.0	1
12C14-12MIX90	7753-20715	5/8	15.9	1 3/16-16	7/8	1 1/16	2.66	67.6	3.60	91.4	2.83	71.9	1

- EQUIPMENT
- HOSE/CPLG. SELECTION
- GLOBALSPIRAL COUPLINGS
- PCM/PCS FERRULES
- MEGACRIMP COUPLINGS
- POWER CRIMP COUPLINGS
- LOW PRESSURE COUPLINGS
- POLARSEAL COUPLINGS
- C14 COUPLINGS**
- PCTS THERMO-PLASTIC COUPLINGS
- FIELD ATTACHABLE G1 & G2 COUPLINGS
- FIELD ATTACHABLE C5 COUPLINGS
- SURELOK AIR BRAKE COUPLINGS
- QUICK DISCONNECT COUPLERS
- NEW BALL VALVES
- ACCESSORIES
- EQUIPMENT AND PARTS



# C14 Couplings



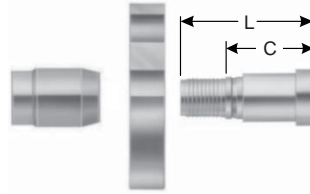

## Two-Bolt Flange Swivel - Brass (Steel Flange) - 'Laundry Flange'



Descr.	Prod. No.	⊖		A	L		C		Std. Pack
		"	mm		"	mm	"	mm	
<b>STANDARD PACK</b>									
6C14-6TBFLX	7753-10255	5/16	7.9	2.00	1.10	28.1	.28	7.1	1
12C14-12TBFLX	7753-10265	5/8	15.9	2.00	2.27	57.6	.59	15.0	1
16C14-16TBFLX	7753-10275	7/8	22.2	2.00	2.45	62.3	.81	20.6	1

## Power Trim Assemblies - Steel

Descr.	Prod. No.	⊖			L				Std. Pack
		"	mm		"	mm			
<b>STANDARD PACK</b>									
PTA-45	7752-00455	3/16	4.8	3/8-24	14.50	368.3	1000	2500	1
PTA-90	7752-00905	3/16	4.8	3/8-24	14.50	368.3	1000	2500	1

## C14 Assembly with Two Female Dual Seat JIC 37°/SAE 45° Flare Swivel (FJSX) Couplings-Steel



Descr.	Prod. No.	⊖		L		Std. Pack
		"	mm	"	mm	
<b>STANDARD PACK</b>						
10C14-10FJSX-10FJSX-18	4479-0002	1/2	12.7	18.00	457.2	1
10C14-10FJSX-10FJSX-24	4479-0003	1/2	12.7	24.00	609.6	1
10C14-10FJSX-10FJSX-30	4479-0004	1/2	12.7	30.00	762.0	1
10C14-10FJSX-10FJSX-36	4479-0005	1/2	12.7	36.00	914.4	1
10C14-10FJSX-10FJSX-42	4479-0006	1/2	12.7	42.00	1066.8	1
10C14-10FJSX-10FJSX-48	4479-0007	1/2	12.7	48.00	1219.2	1
10C14-10FJSX-10FJSX-54	4479-0008	1/2	12.7	54.00	1371.6	1
10C14-10FJSX-10FJSX-72	4479-0009	1/2	12.7	72.00	1828.8	1
10C14-10FJSX-10FJSX-84	4479-0010	1/2	12.7	84.00	2133.6	1

EQUIPMENT

HOSE/CPLG. SELECTION

GLOBALSPIRAL COUPLINGS

PCM/PCS FERRULES

MEGACRIMP COUPLINGS

POWER CRIMP COUPLINGS

LOW PRESSURE COUPLINGS

POLARSEAL COUPLINGS

C14 COUPLINGS

PCTS THERMO-PLASTIC COUPLINGS

FIELD ATTACHABLE G1 &amp; G2 COUPLINGS

FIELD ATTACHABLE C5 COUPLINGS

SURELOK AIR BRAKE COUPLINGS

QUICK DISCONNECT COUPLERS

NEW BALL VALVES

ACCESSORIES

EQUIPMENT AND PARTS



The World's Most Trusted Name in Belts, Hose and Hydraulics.

[www.gates.com/hydraulics](http://www.gates.com/hydraulics)

J9



# C14 Couplings

EQUIPMENT
HOSE/CPLG. SELECTION
GLOBALSPIRAL COUPLINGS
PCM/PCS FERRULES
MEGACRIMP COUPLINGS
POWER CRIMP COUPLINGS
LOW PRESSURE COUPLINGS
POLARSEAL COUPLINGS
<b>C14 COUPLINGS</b>
PCTS THERMO-PLASTIC COUPLINGS
FIELD ATTACHABLE G1 & G2 COUPLINGS
FIELD ATTACHABLE C5 COUPLINGS
SURELOK AIR BRAKE COUPLINGS
QUICK DISCONNECT COUPLERS
NEW BALL VALVES
ACCESSORIES
EQUIPMENT AND PARTS

## C14 Assembly with Two Air Brake Compression (ABC) Couplings - Steel



Descr.	Prod. No.	⊖		L		Std. Pack
		"	mm	"	mm	
<b>STANDARD PACK</b>						
10C14-10ABC-10ABC-18	4479-0011	1/2	12.7	18.00	457.2	1
10C14-10ABC-10ABC-24	4479-0012	1/2	12.7	24.00	609.6	1

## C14 Assembly with Two Straight Tube Assembly (STA) Couplings - Steel



Descr.	Prod. No.	⊖		L		Std. Pack
		"	mm	"	mm	
<b>STANDARD PACK</b>						
10C14-10STA-10STA-18	4479-0013	1/2	12.7	18.00	457.2	1
10C14-10STA-10STA-24	4479-0014	1/2	12.7	24.00	609.6	1
10C14-10STA-10STA-36	4479-0015	1/2	12.7	36.00	914.4	1

## C14 One Straight Tube Assembly (STA) and One Air Brake Compression (ABC) Couplings - Steel



Descr.	Prod. No.	⊖		L		Std. Pack
		"	mm	"	mm	
<b>STANDARD PACK</b>						
10C14-10STA-10ABC-18	4479-0016	1/2	12.7	18.00	457.2	1
10C14-10STA-10ABC-24	4479-0017	1/2	12.7	24.00	609.6	1
10C14-10STA-10ABC-36	4479-0018	1/2	12.7	36.00	914.4	1
10C14-10STA-10ABC-48	4479-0019	1/2	12.7	48.00	1219.2	1
12C14-12STA-12ABC-24	4479-0022	5/8	12.7	24.00	609.6	1
12C14-12STA-12ABC-36	4479-0023	5/8	12.7	36.00	914.4	1
12C14-12STA-12ABC-48	4479-0024	5/8	15.9	48.00	1219.2	1

